



OE

VOLVO

240 (P242, P244)

08.74 - 08.93

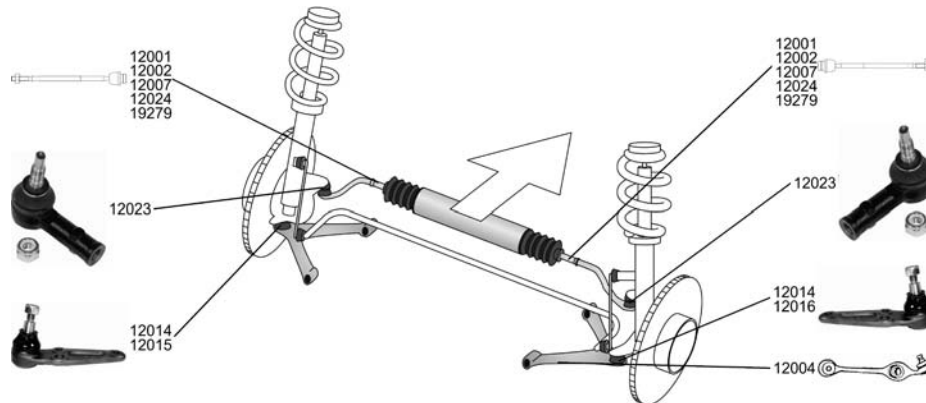









<p>Spurstangenkopf / Tie-rod End Konusmaß [mm] / Cone Size [mm]:14 Gewindeart: mit Rechtsgewinde / Thread Type: with right-hand thread Innengewinde [mm] / Inner Thread [mm]:M14x2 Gewindemaß / Thread Size:M14x2 für Lenkgetriebe-ID / For steering rack ID:ZF/CAM/TRW</p>		<p>12023 3 516 944</p>																																						
<table border="0"> <tr><td>2.0, 60 kW</td><td>08.74 - 07.76</td></tr> <tr><td>2.0, 66 kW</td><td>08.76 - 07.79</td></tr> <tr><td>2.0, 71 kW</td><td>09.78 - 08.83</td></tr> <tr><td>2.0, 76 kW</td><td>08.84 - 07.85</td></tr> <tr><td>2.1, 71 kW</td><td>08.74 - 07.75</td></tr> <tr><td>2.1, 74 kW</td><td>08.75 - 07.80</td></tr> <tr><td>2.1, 79 kW</td><td>08.80 - 07.84</td></tr> <tr><td>2.1, 90 kW</td><td>08.74 - 07.80</td></tr> <tr><td>2.1 Turbo</td><td>08.80 - 07.84</td></tr> <tr><td>2.3, 81 kW</td><td>08.84 - 07.86</td></tr> <tr><td>2.3, 82 kW</td><td>08.80 - 07.84</td></tr> <tr><td>2.3, 83 kW</td><td>08.86 - 07.87</td></tr> <tr><td>2.3 i KAT</td><td>08.86 - 07.93</td></tr> <tr><td>2.3, 96 kW</td><td>08.83 - 07.85</td></tr> <tr><td>2.3, 98 kW</td><td>08.84 - 12.89</td></tr> <tr><td>2.3, 100 kW</td><td>08.80 - 07.83</td></tr> <tr><td>2.3, 103 kW</td><td>08.78 - 07.80</td></tr> <tr><td>2.7 GLT6</td><td>08.79 - 07.80</td></tr> <tr><td>2.4 Diesel</td><td>08.78 - 08.93</td></tr> </table>	2.0, 60 kW	08.74 - 07.76	2.0, 66 kW	08.76 - 07.79	2.0, 71 kW	09.78 - 08.83	2.0, 76 kW	08.84 - 07.85	2.1, 71 kW	08.74 - 07.75	2.1, 74 kW	08.75 - 07.80	2.1, 79 kW	08.80 - 07.84	2.1, 90 kW	08.74 - 07.80	2.1 Turbo	08.80 - 07.84	2.3, 81 kW	08.84 - 07.86	2.3, 82 kW	08.80 - 07.84	2.3, 83 kW	08.86 - 07.87	2.3 i KAT	08.86 - 07.93	2.3, 96 kW	08.83 - 07.85	2.3, 98 kW	08.84 - 12.89	2.3, 100 kW	08.80 - 07.83	2.3, 103 kW	08.78 - 07.80	2.7 GLT6	08.79 - 07.80	2.4 Diesel	08.78 - 08.93		
2.0, 60 kW	08.74 - 07.76																																							
2.0, 66 kW	08.76 - 07.79																																							
2.0, 71 kW	09.78 - 08.83																																							
2.0, 76 kW	08.84 - 07.85																																							
2.1, 71 kW	08.74 - 07.75																																							
2.1, 74 kW	08.75 - 07.80																																							
2.1, 79 kW	08.80 - 07.84																																							
2.1, 90 kW	08.74 - 07.80																																							
2.1 Turbo	08.80 - 07.84																																							
2.3, 81 kW	08.84 - 07.86																																							
2.3, 82 kW	08.80 - 07.84																																							
2.3, 83 kW	08.86 - 07.87																																							
2.3 i KAT	08.86 - 07.93																																							
2.3, 96 kW	08.83 - 07.85																																							
2.3, 98 kW	08.84 - 12.89																																							
2.3, 100 kW	08.80 - 07.83																																							
2.3, 103 kW	08.78 - 07.80																																							
2.7 GLT6	08.79 - 07.80																																							
2.4 Diesel	08.78 - 08.93																																							
<p>Axialgelenk, Spurstange / Axial Rod, tie rod für / for:CAM Innengewinde [mm] / Inner Thread [mm]:M14x1,5 Gewindeart: mit Rechtsgewinde / Thread Type: with right-hand thread Achsausführung / Axle Version:CAM</p>		<p>12001 1 205 659</p>																																						
<table border="0"> <tr><td>2.0, 60 kW</td><td>08.74 - 07.76</td></tr> <tr><td>2.0, 66 kW</td><td>08.76 - 07.79</td></tr> <tr><td>2.0, 71 kW</td><td>09.78 - 08.83</td></tr> <tr><td>2.0, 76 kW</td><td>08.84 - 07.85</td></tr> <tr><td>2.1, 71 kW</td><td>08.74 - 07.75</td></tr> <tr><td>2.1, 74 kW</td><td>08.75 - 07.80</td></tr> <tr><td>2.1, 79 kW</td><td>08.80 - 07.84</td></tr> <tr><td>2.1, 90 kW</td><td>08.74 - 07.80</td></tr> <tr><td>2.3, 81 kW</td><td>08.84 - 07.86</td></tr> <tr><td>2.3, 82 kW</td><td>08.80 - 07.84</td></tr> <tr><td>2.3, 83 kW</td><td>08.86 - 07.87</td></tr> <tr><td>2.3 i KAT</td><td>08.86 - 07.93</td></tr> <tr><td>2.3, 96 kW</td><td>08.83 - 07.85</td></tr> <tr><td>2.3, 98 kW</td><td>08.84 - 12.89</td></tr> <tr><td>2.3, 100 kW</td><td>08.80 - 07.83</td></tr> <tr><td>2.3, 103 kW</td><td>08.78 - 07.80</td></tr> <tr><td>2.7 GLT6</td><td>08.79 - 07.80</td></tr> <tr><td>2.4 Diesel, 58 kW</td><td>08.87 - 08.93</td></tr> <tr><td>2.4 Diesel, 60 kW</td><td>08.78 - 07.85</td></tr> </table>	2.0, 60 kW	08.74 - 07.76	2.0, 66 kW	08.76 - 07.79	2.0, 71 kW	09.78 - 08.83	2.0, 76 kW	08.84 - 07.85	2.1, 71 kW	08.74 - 07.75	2.1, 74 kW	08.75 - 07.80	2.1, 79 kW	08.80 - 07.84	2.1, 90 kW	08.74 - 07.80	2.3, 81 kW	08.84 - 07.86	2.3, 82 kW	08.80 - 07.84	2.3, 83 kW	08.86 - 07.87	2.3 i KAT	08.86 - 07.93	2.3, 96 kW	08.83 - 07.85	2.3, 98 kW	08.84 - 12.89	2.3, 100 kW	08.80 - 07.83	2.3, 103 kW	08.78 - 07.80	2.7 GLT6	08.79 - 07.80	2.4 Diesel, 58 kW	08.87 - 08.93	2.4 Diesel, 60 kW	08.78 - 07.85	<p>08.1984-></p>	
2.0, 60 kW	08.74 - 07.76																																							
2.0, 66 kW	08.76 - 07.79																																							
2.0, 71 kW	09.78 - 08.83																																							
2.0, 76 kW	08.84 - 07.85																																							
2.1, 71 kW	08.74 - 07.75																																							
2.1, 74 kW	08.75 - 07.80																																							
2.1, 79 kW	08.80 - 07.84																																							
2.1, 90 kW	08.74 - 07.80																																							
2.3, 81 kW	08.84 - 07.86																																							
2.3, 82 kW	08.80 - 07.84																																							
2.3, 83 kW	08.86 - 07.87																																							
2.3 i KAT	08.86 - 07.93																																							
2.3, 96 kW	08.83 - 07.85																																							
2.3, 98 kW	08.84 - 12.89																																							
2.3, 100 kW	08.80 - 07.83																																							
2.3, 103 kW	08.78 - 07.80																																							
2.7 GLT6	08.79 - 07.80																																							
2.4 Diesel, 58 kW	08.87 - 08.93																																							
2.4 Diesel, 60 kW	08.78 - 07.85																																							
<p>Axialgelenk, Spurstange / Axial Rod, tie rod Gewindemaß / Thread Size:M20x1,5 Gewindeart: mit Rechtsgewinde / Thread Type: with right-hand thread</p>		<p>12002</p>																																						
<table border="0"> <tr><td>2.0, 60 kW</td><td>08.74 - 07.76</td></tr> <tr><td>2.1, 71 kW</td><td>08.74 - 07.75</td></tr> <tr><td>2.1, 90 kW</td><td>08.74 - 07.80</td></tr> </table>	2.0, 60 kW	08.74 - 07.76	2.1, 71 kW	08.74 - 07.75	2.1, 90 kW	08.74 - 07.80	<p>->03.1979</p>																																	
2.0, 60 kW	08.74 - 07.76																																							
2.1, 71 kW	08.74 - 07.75																																							
2.1, 90 kW	08.74 - 07.80																																							



VOLVO

240 (P242, P244)

08.74 - 08.93

<p> Axialgelenk, Spurstange / Axial Rod, tie rod Gewindemaß / Thread Size: M20x1,5 Gewindeart: mit Rechtsgewinde / Thread Type: with right-hand thread für / for: CAM</p> <table border="1"> <tr><td>2.0, 66 kW</td><td>08.76 - 07.79</td></tr> <tr><td>2.0, 71 kW</td><td>09.78 - 08.83</td></tr> <tr><td>2.0, 76 kW</td><td>08.84 - 07.85</td></tr> <tr><td>2.1, 74 kW</td><td>08.75 - 07.80</td></tr> <tr><td>2.1, 79 kW</td><td>08.80 - 07.84</td></tr> <tr><td>2.3, 81 kW</td><td>08.84 - 07.86</td></tr> <tr><td>2.3, 82 kW</td><td>08.80 - 07.84</td></tr> <tr><td>2.3, 96 kW</td><td>08.83 - 07.85</td></tr> <tr><td>2.3, 98 kW</td><td>08.84 - 12.89</td></tr> <tr><td>2.7 GLT6</td><td>08.79 - 07.80</td></tr> <tr><td>2.1, 90 kW</td><td>08.74 - 07.80</td></tr> <tr><td colspan="2"> </td></tr> <tr><td>2.3, 100 kW</td><td>08.80 - 07.83</td></tr> <tr><td>2.3, 103 kW</td><td>08.78 - 07.80</td></tr> <tr><td>2.4 Diesel, 60 kW</td><td>08.78 - 07.85</td></tr> </table>	2.0, 66 kW	08.76 - 07.79	2.0, 71 kW	09.78 - 08.83	2.0, 76 kW	08.84 - 07.85	2.1, 74 kW	08.75 - 07.80	2.1, 79 kW	08.80 - 07.84	2.3, 81 kW	08.84 - 07.86	2.3, 82 kW	08.80 - 07.84	2.3, 96 kW	08.83 - 07.85	2.3, 98 kW	08.84 - 12.89	2.7 GLT6	08.79 - 07.80	2.1, 90 kW	08.74 - 07.80			2.3, 100 kW	08.80 - 07.83	2.3, 103 kW	08.78 - 07.80	2.4 Diesel, 60 kW	08.78 - 07.85	<p></p> <p>für Lenkgetriebe-ID / For steering rack ID: 1 329 998/9</p> <p>04.1979-> für Lenkgetriebe-ID / For steering rack ID: 1 329 998/9</p> <p>08.1984-> für Lenkgetriebe-ID / For steering rack ID: 1 329 998/9</p>	<p>12007 1 272 947</p> 				
2.0, 66 kW	08.76 - 07.79																																			
2.0, 71 kW	09.78 - 08.83																																			
2.0, 76 kW	08.84 - 07.85																																			
2.1, 74 kW	08.75 - 07.80																																			
2.1, 79 kW	08.80 - 07.84																																			
2.3, 81 kW	08.84 - 07.86																																			
2.3, 82 kW	08.80 - 07.84																																			
2.3, 96 kW	08.83 - 07.85																																			
2.3, 98 kW	08.84 - 12.89																																			
2.7 GLT6	08.79 - 07.80																																			
2.1, 90 kW	08.74 - 07.80																																			
2.3, 100 kW	08.80 - 07.83																																			
2.3, 103 kW	08.78 - 07.80																																			
2.4 Diesel, 60 kW	08.78 - 07.85																																			
<p>Axialgelenk, Spurstange / Axial Rod, tie rod für / for: ZF Gewindemaß / Thread Size: M14x1,5 Gewindeart: mit Rechtsgewinde / Thread Type: with right-hand thread</p> <table border="1"> <tr><td>2.0, 60 kW</td><td>08.74 - 07.76</td></tr> <tr><td>2.0, 66 kW</td><td>08.76 - 07.79</td></tr> <tr><td>2.0, 71 kW</td><td>09.78 - 08.83</td></tr> <tr><td>2.0, 76 kW</td><td>08.84 - 07.85</td></tr> <tr><td>2.1, 71 kW</td><td>08.74 - 07.75</td></tr> <tr><td>2.1, 74 kW</td><td>08.75 - 07.80</td></tr> <tr><td>2.1, 79 kW</td><td>08.80 - 07.84</td></tr> <tr><td>2.1, 90 kW</td><td>08.74 - 07.80</td></tr> <tr><td>2.3, 81 kW</td><td>08.84 - 07.86</td></tr> <tr><td>2.3, 82 kW</td><td>08.80 - 07.84</td></tr> <tr><td>2.3, 83 kW</td><td>08.86 - 07.87</td></tr> <tr><td>2.3 i KAT</td><td>08.86 - 07.93</td></tr> <tr><td>2.3, 96 kW</td><td>08.83 - 07.85</td></tr> <tr><td>2.3, 98 kW</td><td>08.84 - 12.89</td></tr> <tr><td>2.7 GLT6</td><td>08.79 - 07.80</td></tr> <tr><td>2.4 Diesel, 58 kW</td><td>08.87 - 08.93</td></tr> <tr><td>2.4 Diesel, 60 kW</td><td>08.78 - 07.85</td></tr> </table>	2.0, 60 kW	08.74 - 07.76	2.0, 66 kW	08.76 - 07.79	2.0, 71 kW	09.78 - 08.83	2.0, 76 kW	08.84 - 07.85	2.1, 71 kW	08.74 - 07.75	2.1, 74 kW	08.75 - 07.80	2.1, 79 kW	08.80 - 07.84	2.1, 90 kW	08.74 - 07.80	2.3, 81 kW	08.84 - 07.86	2.3, 82 kW	08.80 - 07.84	2.3, 83 kW	08.86 - 07.87	2.3 i KAT	08.86 - 07.93	2.3, 96 kW	08.83 - 07.85	2.3, 98 kW	08.84 - 12.89	2.7 GLT6	08.79 - 07.80	2.4 Diesel, 58 kW	08.87 - 08.93	2.4 Diesel, 60 kW	08.78 - 07.85	<p></p> <p>08.1984-></p>	<p>12024 3 530 167</p> 
2.0, 60 kW	08.74 - 07.76																																			
2.0, 66 kW	08.76 - 07.79																																			
2.0, 71 kW	09.78 - 08.83																																			
2.0, 76 kW	08.84 - 07.85																																			
2.1, 71 kW	08.74 - 07.75																																			
2.1, 74 kW	08.75 - 07.80																																			
2.1, 79 kW	08.80 - 07.84																																			
2.1, 90 kW	08.74 - 07.80																																			
2.3, 81 kW	08.84 - 07.86																																			
2.3, 82 kW	08.80 - 07.84																																			
2.3, 83 kW	08.86 - 07.87																																			
2.3 i KAT	08.86 - 07.93																																			
2.3, 96 kW	08.83 - 07.85																																			
2.3, 98 kW	08.84 - 12.89																																			
2.7 GLT6	08.79 - 07.80																																			
2.4 Diesel, 58 kW	08.87 - 08.93																																			
2.4 Diesel, 60 kW	08.78 - 07.85																																			
<p>Axialgelenk, Spurstange / Axial Rod, tie rod</p> <table border="1"> <tr><td>2.0, 71 kW</td><td>09.78 - 08.83</td></tr> <tr><td>2.0, 76 kW</td><td>08.84 - 07.85</td></tr> <tr><td>2.1, 79 kW</td><td>08.80 - 07.84</td></tr> <tr><td>2.1 Turbo</td><td>08.80 - 07.84</td></tr> <tr><td>2.3, 81 kW</td><td>08.84 - 07.86</td></tr> <tr><td>2.3, 82 kW</td><td>08.80 - 07.84</td></tr> <tr><td>2.3, 83 kW</td><td>08.86 - 07.87</td></tr> <tr><td>2.3 i KAT</td><td>08.86 - 07.93</td></tr> <tr><td>2.3, 96 kW</td><td>08.83 - 07.85</td></tr> <tr><td>2.3, 98 kW</td><td>08.84 - 12.89</td></tr> <tr><td>2.3, 100 kW</td><td>08.80 - 07.83</td></tr> <tr><td>2.4 Diesel</td><td>08.78 - 08.93</td></tr> </table>	2.0, 71 kW	09.78 - 08.83	2.0, 76 kW	08.84 - 07.85	2.1, 79 kW	08.80 - 07.84	2.1 Turbo	08.80 - 07.84	2.3, 81 kW	08.84 - 07.86	2.3, 82 kW	08.80 - 07.84	2.3, 83 kW	08.86 - 07.87	2.3 i KAT	08.86 - 07.93	2.3, 96 kW	08.83 - 07.85	2.3, 98 kW	08.84 - 12.89	2.3, 100 kW	08.80 - 07.83	2.4 Diesel	08.78 - 08.93	<p></p>	<p>19279 9 140 505</p> 										
2.0, 71 kW	09.78 - 08.83																																			
2.0, 76 kW	08.84 - 07.85																																			
2.1, 79 kW	08.80 - 07.84																																			
2.1 Turbo	08.80 - 07.84																																			
2.3, 81 kW	08.84 - 07.86																																			
2.3, 82 kW	08.80 - 07.84																																			
2.3, 83 kW	08.86 - 07.87																																			
2.3 i KAT	08.86 - 07.93																																			
2.3, 96 kW	08.83 - 07.85																																			
2.3, 98 kW	08.84 - 12.89																																			
2.3, 100 kW	08.80 - 07.83																																			
2.4 Diesel	08.78 - 08.93																																			
<p>Lenker, Radaufhängung / Track Control Arm mit Gummilager / with rubber mounting</p> <table border="1"> <tr><td>2.0, 60 kW</td><td>08.74 - 07.76</td></tr> <tr><td>2.0, 66 kW</td><td>08.76 - 07.79</td></tr> <tr><td>2.0, 71 kW</td><td>09.78 - 08.83</td></tr> <tr><td>2.0, 76 kW</td><td>08.84 - 07.85</td></tr> <tr><td>2.1, 71 kW</td><td>08.74 - 07.75</td></tr> <tr><td>2.1, 74 kW</td><td>08.75 - 07.80</td></tr> <tr><td>2.1, 79 kW</td><td>08.80 - 07.84</td></tr> <tr><td>2.1, 90 kW</td><td>08.74 - 07.80</td></tr> <tr><td>2.1 Turbo</td><td>08.80 - 07.84</td></tr> <tr><td>2.3</td><td>08.78 - 12.89</td></tr> <tr><td>2.3 i KAT</td><td>08.86 - 07.93</td></tr> <tr><td>2.7 GLT6</td><td>08.79 - 07.80</td></tr> <tr><td>2.4 Diesel</td><td>08.78 - 08.93</td></tr> </table>	2.0, 60 kW	08.74 - 07.76	2.0, 66 kW	08.76 - 07.79	2.0, 71 kW	09.78 - 08.83	2.0, 76 kW	08.84 - 07.85	2.1, 71 kW	08.74 - 07.75	2.1, 74 kW	08.75 - 07.80	2.1, 79 kW	08.80 - 07.84	2.1, 90 kW	08.74 - 07.80	2.1 Turbo	08.80 - 07.84	2.3	08.78 - 12.89	2.3 i KAT	08.86 - 07.93	2.7 GLT6	08.79 - 07.80	2.4 Diesel	08.78 - 08.93	<p></p>	<p>12004</p> 								
2.0, 60 kW	08.74 - 07.76																																			
2.0, 66 kW	08.76 - 07.79																																			
2.0, 71 kW	09.78 - 08.83																																			
2.0, 76 kW	08.84 - 07.85																																			
2.1, 71 kW	08.74 - 07.75																																			
2.1, 74 kW	08.75 - 07.80																																			
2.1, 79 kW	08.80 - 07.84																																			
2.1, 90 kW	08.74 - 07.80																																			
2.1 Turbo	08.80 - 07.84																																			
2.3	08.78 - 12.89																																			
2.3 i KAT	08.86 - 07.93																																			
2.7 GLT6	08.79 - 07.80																																			
2.4 Diesel	08.78 - 08.93																																			











OE

VOLVO

240 (P242, P244)

08.74 - 08.93



<p> Trag-/Führungsgelenk / Support-/ Steering Link mit Befestigungsmaterial / with fastening material</p> <table border="1"> <tr><td>2.0, 60 kW</td><td>08.74 - 07.76</td></tr> <tr><td>2.0, 66 kW</td><td>08.76 - 07.79</td></tr> <tr><td>2.0, 71 kW</td><td>09.78 - 08.83</td></tr> <tr><td>2.0, 76 kW</td><td>08.84 - 07.85</td></tr> <tr><td>2.1, 71 kW</td><td>08.74 - 07.75</td></tr> <tr><td>2.1, 74 kW</td><td>08.75 - 07.80</td></tr> <tr><td>2.1, 79 kW</td><td>08.80 - 07.84</td></tr> <tr><td>2.1, 90 kW</td><td>08.74 - 07.80</td></tr> <tr><td>2.3, 83 kW</td><td>08.86 - 07.87</td></tr> <tr><td>2.3 i KAT</td><td>08.86 - 07.93</td></tr> <tr><td>2.3, 103 kW</td><td>08.78 - 07.80</td></tr> <tr><td>2.7 GLT6</td><td>08.79 - 07.80</td></tr> <tr><td>2.4 Diesel, 58 kW</td><td>08.87 - 08.93</td></tr> </table>	2.0, 60 kW	08.74 - 07.76	2.0, 66 kW	08.76 - 07.79	2.0, 71 kW	09.78 - 08.83	2.0, 76 kW	08.84 - 07.85	2.1, 71 kW	08.74 - 07.75	2.1, 74 kW	08.75 - 07.80	2.1, 79 kW	08.80 - 07.84	2.1, 90 kW	08.74 - 07.80	2.3, 83 kW	08.86 - 07.87	2.3 i KAT	08.86 - 07.93	2.3, 103 kW	08.78 - 07.80	2.7 GLT6	08.79 - 07.80	2.4 Diesel, 58 kW	08.87 - 08.93	<p>▼↔</p>	<p>12014 274 117</p> 
2.0, 60 kW	08.74 - 07.76																											
2.0, 66 kW	08.76 - 07.79																											
2.0, 71 kW	09.78 - 08.83																											
2.0, 76 kW	08.84 - 07.85																											
2.1, 71 kW	08.74 - 07.75																											
2.1, 74 kW	08.75 - 07.80																											
2.1, 79 kW	08.80 - 07.84																											
2.1, 90 kW	08.74 - 07.80																											
2.3, 83 kW	08.86 - 07.87																											
2.3 i KAT	08.86 - 07.93																											
2.3, 103 kW	08.78 - 07.80																											
2.7 GLT6	08.79 - 07.80																											
2.4 Diesel, 58 kW	08.87 - 08.93																											
<p>Trag-/Führungsgelenk / Support-/ Steering Link ohne Zubehör / without accessories</p> <table border="1"> <tr><td>2.1 Turbo</td><td>08.80 - 07.84</td></tr> <tr><td>2.3, 81 kW</td><td>08.84 - 07.86</td></tr> <tr><td>2.3, 82 kW</td><td>08.80 - 07.84</td></tr> <tr><td>2.3, 96 kW</td><td>08.83 - 07.85</td></tr> <tr><td>2.3, 98 kW</td><td>08.84 - 12.89</td></tr> <tr><td>2.3, 100 kW</td><td>08.80 - 07.83</td></tr> <tr><td>2.4 Diesel, 60 kW</td><td>08.78 - 07.85</td></tr> </table>	2.1 Turbo	08.80 - 07.84	2.3, 81 kW	08.84 - 07.86	2.3, 82 kW	08.80 - 07.84	2.3, 96 kW	08.83 - 07.85	2.3, 98 kW	08.84 - 12.89	2.3, 100 kW	08.80 - 07.83	2.4 Diesel, 60 kW	08.78 - 07.85	<p>▼↔</p>	<p>12015 274 118</p> 												
2.1 Turbo	08.80 - 07.84																											
2.3, 81 kW	08.84 - 07.86																											
2.3, 82 kW	08.80 - 07.84																											
2.3, 96 kW	08.83 - 07.85																											
2.3, 98 kW	08.84 - 12.89																											
2.3, 100 kW	08.80 - 07.83																											
2.4 Diesel, 60 kW	08.78 - 07.85																											
<p>Trag-/Führungsgelenk / Support-/ Steering Link</p> <table border="1"> <tr><td>2.1 Turbo</td><td>08.80 - 07.84</td></tr> <tr><td>2.3, 81 kW</td><td>08.84 - 07.86</td></tr> <tr><td>2.3, 82 kW</td><td>08.80 - 07.84</td></tr> <tr><td>2.3, 96 kW</td><td>08.83 - 07.85</td></tr> <tr><td>2.3, 98 kW</td><td>08.84 - 12.89</td></tr> <tr><td>2.3, 100 kW</td><td>08.80 - 07.83</td></tr> <tr><td>2.4 Diesel, 60 kW</td><td>08.78 - 07.85</td></tr> </table>	2.1 Turbo	08.80 - 07.84	2.3, 81 kW	08.84 - 07.86	2.3, 82 kW	08.80 - 07.84	2.3, 96 kW	08.83 - 07.85	2.3, 98 kW	08.84 - 12.89	2.3, 100 kW	08.80 - 07.83	2.4 Diesel, 60 kW	08.78 - 07.85	<p>▼↔</p>	<p>12016 274 119</p> 												
2.1 Turbo	08.80 - 07.84																											
2.3, 81 kW	08.84 - 07.86																											
2.3, 82 kW	08.80 - 07.84																											
2.3, 96 kW	08.83 - 07.85																											
2.3, 98 kW	08.84 - 12.89																											
2.3, 100 kW	08.80 - 07.83																											
2.4 Diesel, 60 kW	08.78 - 07.85																											
<p>Lagerung, Lenker / Mounting, wishbone</p> <p>ALL TYPES ausser/except for :</p> <table border="1"> <tr><td>2.1, 71 kW</td><td>09.78 - 12.93</td></tr> <tr><td>2.1, 71 kW</td><td>01.74 - 08.84</td></tr> <tr><td>2.1 Turbo-Inj.</td><td>01.80 - 12.93</td></tr> </table>	2.1, 71 kW	09.78 - 12.93	2.1, 71 kW	01.74 - 08.84	2.1 Turbo-Inj.	01.80 - 12.93	<p>▼↔↓</p>	<p>11756 1 273 778</p> 																				
2.1, 71 kW	09.78 - 12.93																											
2.1, 71 kW	01.74 - 08.84																											
2.1 Turbo-Inj.	01.80 - 12.93																											
<p>Lagerung, Lenker / Mounting, wishbone</p> <p>ALL TYPES ausser/except for :</p> <table border="1"> <tr><td>2.1, 71 kW</td><td>09.78 - 12.93</td></tr> <tr><td>2.1, 71 kW</td><td>01.74 - 08.84</td></tr> <tr><td>2.1 Turbo-Inj.</td><td>01.80 - 12.93</td></tr> </table>	2.1, 71 kW	09.78 - 12.93	2.1, 71 kW	01.74 - 08.84	2.1 Turbo-Inj.	01.80 - 12.93	<p>▼↔↑</p>	<p>12032 1 205 825</p> 																				
2.1, 71 kW	09.78 - 12.93																											
2.1, 71 kW	01.74 - 08.84																											
2.1 Turbo-Inj.	01.80 - 12.93																											
<p>Lenkwelle / Steering Shaft fahrerseitig / Driver side</p> <table border="1"> <tr><td>2.1 Turbo</td><td>08.80 - 07.84</td></tr> <tr><td>2.3, 81 kW</td><td>08.84 - 07.86</td></tr> <tr><td>2.3, 82 kW</td><td>08.80 - 07.84</td></tr> <tr><td>2.3, 96 kW</td><td>08.83 - 07.85</td></tr> <tr><td>2.3, 98 kW</td><td>08.84 - 12.89</td></tr> <tr><td>2.3, 100 kW</td><td>08.80 - 07.83</td></tr> <tr><td>2.4 Diesel, 60 kW</td><td>08.78 - 07.85</td></tr> </table>	2.1 Turbo	08.80 - 07.84	2.3, 81 kW	08.84 - 07.86	2.3, 82 kW	08.80 - 07.84	2.3, 96 kW	08.83 - 07.85	2.3, 98 kW	08.84 - 12.89	2.3, 100 kW	08.80 - 07.83	2.4 Diesel, 60 kW	08.78 - 07.85		<p>20382</p> 												
2.1 Turbo	08.80 - 07.84																											
2.3, 81 kW	08.84 - 07.86																											
2.3, 82 kW	08.80 - 07.84																											
2.3, 96 kW	08.83 - 07.85																											
2.3, 98 kW	08.84 - 12.89																											
2.3, 100 kW	08.80 - 07.83																											
2.4 Diesel, 60 kW	08.78 - 07.85																											
<p>Faltenbalgsatz, Lenkung / Bellow Kit, steering system</p> <p>ALL TYPES ausser/except for :</p> <table border="1"> <tr><td>2.1, 71 kW</td><td>09.78 - 12.93</td></tr> <tr><td>2.1, 71 kW</td><td>01.74 - 08.84</td></tr> <tr><td>2.1 Turbo-Inj.</td><td>01.80 - 12.93</td></tr> </table>	2.1, 71 kW	09.78 - 12.93	2.1, 71 kW	01.74 - 08.84	2.1 Turbo-Inj.	01.80 - 12.93	<p>↔</p>	<p>30185 1 272 925</p> 																				
2.1, 71 kW	09.78 - 12.93																											
2.1, 71 kW	01.74 - 08.84																											
2.1 Turbo-Inj.	01.80 - 12.93																											
<p>Faltenbalgsatz, Lenkung / Bellow Kit, steering system</p> <p>ALL TYPES ausser/except for :</p> <table border="1"> <tr><td>2.1, 71 kW</td><td>09.78 - 12.93</td></tr> <tr><td>2.1, 71 kW</td><td>01.74 - 08.84</td></tr> <tr><td>2.1 Turbo-Inj.</td><td>01.80 - 12.93</td></tr> </table>	2.1, 71 kW	09.78 - 12.93	2.1, 71 kW	01.74 - 08.84	2.1 Turbo-Inj.	01.80 - 12.93	<p>↔</p>	<p>30186 1 272 924</p> 																				
2.1, 71 kW	09.78 - 12.93																											
2.1, 71 kW	01.74 - 08.84																											
2.1 Turbo-Inj.	01.80 - 12.93																											



VOLVO

240 (P242, P244)



08.74 - 08.93

 Lagerung, Panhardstab / Suspension, panhard rod		20130	1 330 973
2.0, 60 kW	08.74 - 07.76		
2.0, 66 kW	08.76 - 07.79		
2.0, 71 kW	09.78 - 08.83		
2.0, 76 kW	08.84 - 07.85		
2.1, 71 kW	08.74 - 07.75		
2.1, 74 kW	08.75 - 07.80		
2.1, 79 kW	08.80 - 07.84		
2.1, 90 kW	08.74 - 07.80		
2.1 Turbo	08.80 - 07.84		
2.3, 81 kW	08.84 - 07.86		
2.3, 82 kW	08.80 - 07.84		
2.3, 83 kW	08.86 - 07.87		
2.3 i KAT	08.86 - 07.93		
2.3, 96 kW	08.83 - 07.85		
2.3, 98 kW	08.84 - 12.89		
2.3, 100 kW	08.80 - 07.83		
2.3, 103 kW	08.78 - 07.80		
2.7 GLT6	08.79 - 07.80		
2.4 Diesel	08.78 - 08.93		

240 Kombi/Estate/Break (P245)

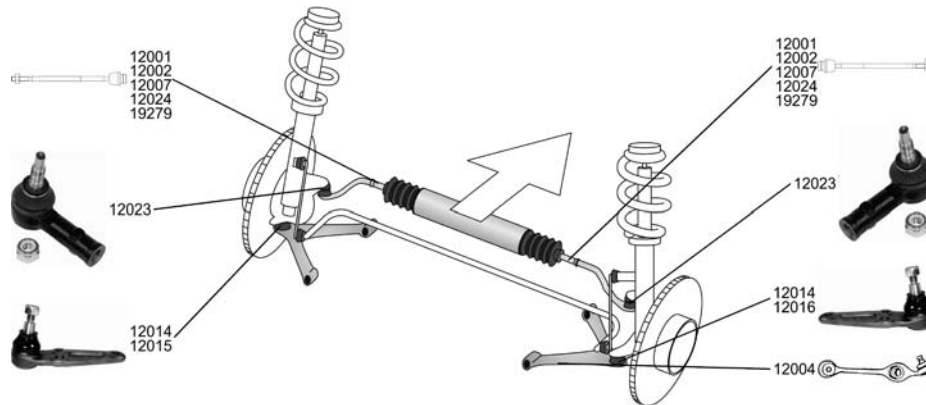
08.74 - 08.93



Spurstangenkopf / Tie-rod End Konusmaß [mm] / Cone Size [mm]:14 Gewindeart: mit Rechtsgewinde / Thread Type: with right-hand thread Innengewinde [mm] / Inner Thread [mm]:M14x2 Gewindemaß / Thread Size:M14x2 für Lenkgetriebe-ID / For steering rack ID:ZF/CAM/TRW	 	12023	3 516 944
2.0, 60 kW	08.74 - 07.75		
2.0, 66 kW	08.76 - 01.82		
2.0, 71 kW	08.80 - 12.84		
2.0, 76 kW	08.84 - 07.85		
2.0, 86 kW	08.83 - 07.93		
2.1, 71 kW	08.74 - 07.75		
2.1, 74 kW	08.75 - 07.80		
2.1, 79 kW	08.80 - 07.84		
2.1, 80 kW	08.80 - 07.84		
2.1, 90 kW	08.74 - 07.79		
2.1 Turbo	08.80 - 07.85		
2.3, 81 kW	08.84 - 07.86		
2.3, 82 kW	08.80 - 07.84		
2.3, 83 kW	08.86 - 07.87		
2.3 i KAT	08.86 - 07.93		
2.3, 96 kW	08.84 - 07.85		
2.3, 98 kW	08.84 - 12.88		
2.3, 100 kW	01.83 - 12.84		
2.7 GLT6	08.79 - 07.80		
2.4 Diesel	04.79 - 08.93		









OE

VOLVO

240 Kombi/Estate/Break (P245)

08.74 - 08.93











<p> Axialgelenk, Spurstange / Axial Rod, tie rod für / for:CAM Innengewinde [mm] / Inner Thread [mm]:M14x1,5 Gewindeart: mit Rechtsgewinde / Thread Type: with right-hand thread Achsausführung / Axle Version:CAM</p> <table border="1"> <tr><td>2.0, 60 kW</td><td>08.74 - 07.75</td></tr> <tr><td>2.0, 66 kW</td><td>08.76 - 01.82</td></tr> <tr><td>2.0, 71 kW</td><td>08.80 - 12.84</td></tr> <tr><td>2.0, 76 kW</td><td>08.84 - 07.85</td></tr> <tr><td>2.0, 86 kW</td><td>08.83 - 07.93</td></tr> <tr><td>2.1, 71 kW</td><td>08.74 - 07.75</td></tr> <tr><td>2.1, 74 kW</td><td>08.75 - 07.80</td></tr> <tr><td>2.1, 79 kW</td><td>08.80 - 07.84</td></tr> <tr><td>2.1, 80 kW</td><td>08.80 - 07.84</td></tr> <tr><td>2.1, 90 kW</td><td>08.74 - 07.79</td></tr> <tr><td>2.3, 81 kW</td><td>08.84 - 07.86</td></tr> <tr><td>2.3, 82 kW</td><td>08.80 - 07.84</td></tr> <tr><td>2.3, 83 kW</td><td>08.86 - 07.87</td></tr> <tr><td>2.3 i KAT</td><td>08.86 - 07.93</td></tr> <tr><td>2.3, 96 kW</td><td>08.84 - 07.85</td></tr> <tr><td>2.3, 98 kW</td><td>08.84 - 12.88</td></tr> <tr><td>2.7 GLT6</td><td>08.79 - 07.80</td></tr> <tr><td>2.4 Diesel, 58 kW</td><td>08.88 - 08.93</td></tr> </table>	2.0, 60 kW	08.74 - 07.75	2.0, 66 kW	08.76 - 01.82	2.0, 71 kW	08.80 - 12.84	2.0, 76 kW	08.84 - 07.85	2.0, 86 kW	08.83 - 07.93	2.1, 71 kW	08.74 - 07.75	2.1, 74 kW	08.75 - 07.80	2.1, 79 kW	08.80 - 07.84	2.1, 80 kW	08.80 - 07.84	2.1, 90 kW	08.74 - 07.79	2.3, 81 kW	08.84 - 07.86	2.3, 82 kW	08.80 - 07.84	2.3, 83 kW	08.86 - 07.87	2.3 i KAT	08.86 - 07.93	2.3, 96 kW	08.84 - 07.85	2.3, 98 kW	08.84 - 12.88	2.7 GLT6	08.79 - 07.80	2.4 Diesel, 58 kW	08.88 - 08.93	<p></p>	<p>12001 1 205 659</p> 
2.0, 60 kW	08.74 - 07.75																																					
2.0, 66 kW	08.76 - 01.82																																					
2.0, 71 kW	08.80 - 12.84																																					
2.0, 76 kW	08.84 - 07.85																																					
2.0, 86 kW	08.83 - 07.93																																					
2.1, 71 kW	08.74 - 07.75																																					
2.1, 74 kW	08.75 - 07.80																																					
2.1, 79 kW	08.80 - 07.84																																					
2.1, 80 kW	08.80 - 07.84																																					
2.1, 90 kW	08.74 - 07.79																																					
2.3, 81 kW	08.84 - 07.86																																					
2.3, 82 kW	08.80 - 07.84																																					
2.3, 83 kW	08.86 - 07.87																																					
2.3 i KAT	08.86 - 07.93																																					
2.3, 96 kW	08.84 - 07.85																																					
2.3, 98 kW	08.84 - 12.88																																					
2.7 GLT6	08.79 - 07.80																																					
2.4 Diesel, 58 kW	08.88 - 08.93																																					
<p>Axialgelenk, Spurstange / Axial Rod, tie rod Gewindemaß / Thread Size:M20x1,5 Gewindeart: mit Rechtsgewinde / Thread Type: with right-hand thread</p> <table border="1"> <tr><td>2.1, 74 kW</td><td>08.75 - 07.80</td></tr> <tr><td>2.1, 90 kW</td><td>08.74 - 07.79</td></tr> <tr><td>2.0, 60 kW</td><td>08.74 - 07.75</td></tr> <tr><td>2.1, 71 kW</td><td>08.74 - 07.75</td></tr> <tr><td>2.1, 79 kW</td><td>08.80 - 07.84</td></tr> <tr><td>2.0, 66 kW</td><td>08.76 - 01.82</td></tr> </table>	2.1, 74 kW	08.75 - 07.80	2.1, 90 kW	08.74 - 07.79	2.0, 60 kW	08.74 - 07.75	2.1, 71 kW	08.74 - 07.75	2.1, 79 kW	08.80 - 07.84	2.0, 66 kW	08.76 - 01.82	<p></p> <p>08.1984-></p> <p>->03.1979</p> <p>->04.1979</p>	<p>12002</p> 																								
2.1, 74 kW	08.75 - 07.80																																					
2.1, 90 kW	08.74 - 07.79																																					
2.0, 60 kW	08.74 - 07.75																																					
2.1, 71 kW	08.74 - 07.75																																					
2.1, 79 kW	08.80 - 07.84																																					
2.0, 66 kW	08.76 - 01.82																																					
<p>Axialgelenk, Spurstange / Axial Rod, tie rod Gewindemaß / Thread Size:M20x1,5 Gewindeart: mit Rechtsgewinde / Thread Type: with right-hand thread für / for:CAM</p> <table border="1"> <tr><td>2.1, 74 kW</td><td>08.75 - 07.80</td></tr> <tr><td>2.1, 80 kW</td><td>08.80 - 07.84</td></tr> <tr><td>2.3, 82 kW</td><td>08.80 - 07.84</td></tr> <tr><td>2.0, 66 kW</td><td>08.76 - 01.82</td></tr> <tr><td>2.1, 90 kW</td><td>08.74 - 07.79</td></tr> <tr><td>2.0, 66 kW</td><td>08.76 - 01.82</td></tr> <tr><td>2.1, 90 kW</td><td>08.74 - 07.79</td></tr> <tr><td>2.1 Turbo</td><td>08.80 - 07.85</td></tr> <tr><td>2.3, 100 kW</td><td>01.83 - 12.84</td></tr> <tr><td>2.4 Diesel, 60 kW</td><td>04.79 - 08.93</td></tr> <tr><td>2.0, 71 kW</td><td>08.80 - 12.84</td></tr> <tr><td>2.0, 76 kW</td><td>08.84 - 07.85</td></tr> <tr><td>2.3, 81 kW</td><td>08.84 - 07.86</td></tr> <tr><td>2.3, 96 kW</td><td>08.84 - 07.85</td></tr> <tr><td>2.3, 98 kW</td><td>08.84 - 12.88</td></tr> <tr><td>2.7 GLT6</td><td>08.79 - 07.80</td></tr> </table>	2.1, 74 kW	08.75 - 07.80	2.1, 80 kW	08.80 - 07.84	2.3, 82 kW	08.80 - 07.84	2.0, 66 kW	08.76 - 01.82	2.1, 90 kW	08.74 - 07.79	2.0, 66 kW	08.76 - 01.82	2.1, 90 kW	08.74 - 07.79	2.1 Turbo	08.80 - 07.85	2.3, 100 kW	01.83 - 12.84	2.4 Diesel, 60 kW	04.79 - 08.93	2.0, 71 kW	08.80 - 12.84	2.0, 76 kW	08.84 - 07.85	2.3, 81 kW	08.84 - 07.86	2.3, 96 kW	08.84 - 07.85	2.3, 98 kW	08.84 - 12.88	2.7 GLT6	08.79 - 07.80	<p></p> <p>04.1979-> für Lenkgetriebe-ID / For steering rack ID:1329 998/9</p> <p>04.1979-></p> <p>04.1979-> für Lenkgetriebe-ID / For steering rack ID:1 329 998/9</p> <p>08.1984-> für Lenkgetriebe-ID / For steering rack ID:1 329 998/9</p> <p>08.80 - 12.84 für Lenkgetriebe-ID / For steering rack ID:1 329 998/9</p>	<p>12007 1 272 947</p> 				
2.1, 74 kW	08.75 - 07.80																																					
2.1, 80 kW	08.80 - 07.84																																					
2.3, 82 kW	08.80 - 07.84																																					
2.0, 66 kW	08.76 - 01.82																																					
2.1, 90 kW	08.74 - 07.79																																					
2.0, 66 kW	08.76 - 01.82																																					
2.1, 90 kW	08.74 - 07.79																																					
2.1 Turbo	08.80 - 07.85																																					
2.3, 100 kW	01.83 - 12.84																																					
2.4 Diesel, 60 kW	04.79 - 08.93																																					
2.0, 71 kW	08.80 - 12.84																																					
2.0, 76 kW	08.84 - 07.85																																					
2.3, 81 kW	08.84 - 07.86																																					
2.3, 96 kW	08.84 - 07.85																																					
2.3, 98 kW	08.84 - 12.88																																					
2.7 GLT6	08.79 - 07.80																																					



VOLVO

240 Kombi/Estate/Break (P245)

08.74 - 08.93

<p> Axialgelenk, Spurstange / Axial Rod, tie rod für / for:ZF Gewindemaß / Thread Size:M14x1,5 Gewindeart: mit Rechtsgewinde / Thread Type: with right-hand thread</p>	<p></p>	<p>12024 3 530 167</p> 																														
<table border="0"> <tr><td>2.0, 60 kW</td><td>08.74 - 07.75</td></tr> <tr><td>2.0, 66 kW</td><td>08.76 - 01.82</td></tr> <tr><td>2.0, 71 kW</td><td>08.80 - 12.84</td></tr> <tr><td>2.0, 76 kW</td><td>08.84 - 07.85</td></tr> <tr><td>2.0, 86 kW</td><td>08.83 - 07.93</td></tr> <tr><td>2.1, 71 kW</td><td>08.74 - 07.75</td></tr> <tr><td>2.1, 74 kW</td><td>08.75 - 07.80</td></tr> <tr><td>2.1, 90 kW</td><td>08.74 - 07.79</td></tr> <tr><td>2.3, 81 kW</td><td>08.84 - 07.86</td></tr> <tr><td>2.3, 83 kW</td><td>08.86 - 07.87</td></tr> <tr><td>2.3 i KAT</td><td>08.86 - 07.93</td></tr> <tr><td>2.3, 96 kW</td><td>08.84 - 07.85</td></tr> <tr><td>2.3, 98 kW</td><td>08.84 - 12.88</td></tr> <tr><td>2.7 GLT6</td><td>08.79 - 07.80</td></tr> <tr><td>2.4 Diesel, 58 kW</td><td>08.88 - 08.93</td></tr> </table>	2.0, 60 kW	08.74 - 07.75	2.0, 66 kW	08.76 - 01.82	2.0, 71 kW	08.80 - 12.84	2.0, 76 kW	08.84 - 07.85	2.0, 86 kW	08.83 - 07.93	2.1, 71 kW	08.74 - 07.75	2.1, 74 kW	08.75 - 07.80	2.1, 90 kW	08.74 - 07.79	2.3, 81 kW	08.84 - 07.86	2.3, 83 kW	08.86 - 07.87	2.3 i KAT	08.86 - 07.93	2.3, 96 kW	08.84 - 07.85	2.3, 98 kW	08.84 - 12.88	2.7 GLT6	08.79 - 07.80	2.4 Diesel, 58 kW	08.88 - 08.93		
2.0, 60 kW	08.74 - 07.75																															
2.0, 66 kW	08.76 - 01.82																															
2.0, 71 kW	08.80 - 12.84																															
2.0, 76 kW	08.84 - 07.85																															
2.0, 86 kW	08.83 - 07.93																															
2.1, 71 kW	08.74 - 07.75																															
2.1, 74 kW	08.75 - 07.80																															
2.1, 90 kW	08.74 - 07.79																															
2.3, 81 kW	08.84 - 07.86																															
2.3, 83 kW	08.86 - 07.87																															
2.3 i KAT	08.86 - 07.93																															
2.3, 96 kW	08.84 - 07.85																															
2.3, 98 kW	08.84 - 12.88																															
2.7 GLT6	08.79 - 07.80																															
2.4 Diesel, 58 kW	08.88 - 08.93																															
<table border="0"> <tr><td>2.1 Turbo</td><td>08.80 - 07.85</td></tr> <tr><td>2.3, 100 kW</td><td>01.83 - 12.84</td></tr> <tr><td>2.4 Diesel, 60 kW</td><td>04.79 - 08.93</td></tr> </table>	2.1 Turbo	08.80 - 07.85	2.3, 100 kW	01.83 - 12.84	2.4 Diesel, 60 kW	04.79 - 08.93	<p>08.1984-></p>																									
2.1 Turbo	08.80 - 07.85																															
2.3, 100 kW	01.83 - 12.84																															
2.4 Diesel, 60 kW	04.79 - 08.93																															
<p>Axialgelenk, Spurstange / Axial Rod, tie rod</p>	<p></p>	<p>19279 9 140 505</p> 																														
<table border="0"> <tr><td>2.0, 66 kW</td><td>08.76 - 01.82</td></tr> <tr><td>2.0, 71 kW</td><td>08.80 - 12.84</td></tr> <tr><td>2.0, 76 kW</td><td>08.84 - 07.85</td></tr> <tr><td>2.1, 80 kW</td><td>08.80 - 07.84</td></tr> <tr><td>2.1 Turbo</td><td>08.80 - 07.85</td></tr> <tr><td>2.3, 81 kW</td><td>08.84 - 07.86</td></tr> <tr><td>2.3, 83 kW</td><td>08.86 - 07.87</td></tr> <tr><td>2.3 i KAT</td><td>08.86 - 07.93</td></tr> <tr><td>2.3, 96 kW</td><td>08.84 - 07.85</td></tr> <tr><td>2.3, 98 kW</td><td>08.84 - 12.88</td></tr> <tr><td>2.3, 100 kW</td><td>01.83 - 12.84</td></tr> <tr><td>2.4 Diesel</td><td>04.79 - 08.93</td></tr> </table>	2.0, 66 kW	08.76 - 01.82	2.0, 71 kW	08.80 - 12.84	2.0, 76 kW	08.84 - 07.85	2.1, 80 kW	08.80 - 07.84	2.1 Turbo	08.80 - 07.85	2.3, 81 kW	08.84 - 07.86	2.3, 83 kW	08.86 - 07.87	2.3 i KAT	08.86 - 07.93	2.3, 96 kW	08.84 - 07.85	2.3, 98 kW	08.84 - 12.88	2.3, 100 kW	01.83 - 12.84	2.4 Diesel	04.79 - 08.93								
2.0, 66 kW	08.76 - 01.82																															
2.0, 71 kW	08.80 - 12.84																															
2.0, 76 kW	08.84 - 07.85																															
2.1, 80 kW	08.80 - 07.84																															
2.1 Turbo	08.80 - 07.85																															
2.3, 81 kW	08.84 - 07.86																															
2.3, 83 kW	08.86 - 07.87																															
2.3 i KAT	08.86 - 07.93																															
2.3, 96 kW	08.84 - 07.85																															
2.3, 98 kW	08.84 - 12.88																															
2.3, 100 kW	01.83 - 12.84																															
2.4 Diesel	04.79 - 08.93																															
<p>Lenker, Radaufhängung / Track Control Arm mit Gummilager / with rubber mounting</p>	<p></p>	<p>12004</p> 																														
<p>ALL TYPES ausser/except for :</p> <table border="0"> <tr><td>2.0, 100 kW</td><td>10.82 - 08.84</td></tr> <tr><td>2.1</td><td>01.74 - 08.84</td></tr> <tr><td>2.3</td><td>01.82 - 08.84</td></tr> </table>	2.0, 100 kW	10.82 - 08.84	2.1	01.74 - 08.84	2.3	01.82 - 08.84																										
2.0, 100 kW	10.82 - 08.84																															
2.1	01.74 - 08.84																															
2.3	01.82 - 08.84																															
<p>Trag-/Führungsgelenk / Support-/ Steering Link mit Befestigungsmaterial / with fastening material</p>	<p></p>	<p>12014 274 117</p> 																														
<table border="0"> <tr><td>2.0, 60 kW</td><td>08.74 - 07.75</td></tr> <tr><td>2.0, 66 kW</td><td>08.76 - 01.82</td></tr> <tr><td>2.0, 86 kW</td><td>08.83 - 07.93</td></tr> <tr><td>2.1, 71 kW</td><td>08.74 - 07.75</td></tr> <tr><td>2.1, 74 kW</td><td>08.75 - 07.80</td></tr> <tr><td>2.1, 79 kW</td><td>08.80 - 07.84</td></tr> <tr><td>2.1, 90 kW</td><td>08.74 - 07.79</td></tr> <tr><td>2.3, 83 kW</td><td>08.86 - 07.87</td></tr> <tr><td>2.3 i KAT</td><td>08.86 - 07.93</td></tr> <tr><td>2.7 GLT6</td><td>08.79 - 07.80</td></tr> <tr><td>2.4 Diesel, 58 kW</td><td>08.88 - 08.93</td></tr> </table>	2.0, 60 kW	08.74 - 07.75	2.0, 66 kW	08.76 - 01.82	2.0, 86 kW	08.83 - 07.93	2.1, 71 kW	08.74 - 07.75	2.1, 74 kW	08.75 - 07.80	2.1, 79 kW	08.80 - 07.84	2.1, 90 kW	08.74 - 07.79	2.3, 83 kW	08.86 - 07.87	2.3 i KAT	08.86 - 07.93	2.7 GLT6	08.79 - 07.80	2.4 Diesel, 58 kW	08.88 - 08.93										
2.0, 60 kW	08.74 - 07.75																															
2.0, 66 kW	08.76 - 01.82																															
2.0, 86 kW	08.83 - 07.93																															
2.1, 71 kW	08.74 - 07.75																															
2.1, 74 kW	08.75 - 07.80																															
2.1, 79 kW	08.80 - 07.84																															
2.1, 90 kW	08.74 - 07.79																															
2.3, 83 kW	08.86 - 07.87																															
2.3 i KAT	08.86 - 07.93																															
2.7 GLT6	08.79 - 07.80																															
2.4 Diesel, 58 kW	08.88 - 08.93																															
<p>Trag-/Führungsgelenk / Support-/ Steering Link ohne Zubehör / without accessories</p>	<p></p>	<p>12015 274 118</p> 																														
<table border="0"> <tr><td>2.0, 71 kW</td><td>08.80 - 12.84</td></tr> <tr><td>2.0, 76 kW</td><td>08.84 - 07.85</td></tr> <tr><td>2.1, 80 kW</td><td>08.80 - 07.84</td></tr> <tr><td>2.1 Turbo</td><td>08.80 - 07.85</td></tr> <tr><td>2.3, 81 kW</td><td>08.84 - 07.86</td></tr> <tr><td>2.3, 82 kW</td><td>08.80 - 07.84</td></tr> <tr><td>2.3, 96 kW</td><td>08.84 - 07.85</td></tr> <tr><td>2.3, 98 kW</td><td>08.84 - 12.88</td></tr> <tr><td>2.3, 100 kW</td><td>01.83 - 12.84</td></tr> <tr><td>2.4 Diesel, 60 kW</td><td>04.79 - 08.93</td></tr> </table>	2.0, 71 kW	08.80 - 12.84	2.0, 76 kW	08.84 - 07.85	2.1, 80 kW	08.80 - 07.84	2.1 Turbo	08.80 - 07.85	2.3, 81 kW	08.84 - 07.86	2.3, 82 kW	08.80 - 07.84	2.3, 96 kW	08.84 - 07.85	2.3, 98 kW	08.84 - 12.88	2.3, 100 kW	01.83 - 12.84	2.4 Diesel, 60 kW	04.79 - 08.93												
2.0, 71 kW	08.80 - 12.84																															
2.0, 76 kW	08.84 - 07.85																															
2.1, 80 kW	08.80 - 07.84																															
2.1 Turbo	08.80 - 07.85																															
2.3, 81 kW	08.84 - 07.86																															
2.3, 82 kW	08.80 - 07.84																															
2.3, 96 kW	08.84 - 07.85																															
2.3, 98 kW	08.84 - 12.88																															
2.3, 100 kW	01.83 - 12.84																															
2.4 Diesel, 60 kW	04.79 - 08.93																															



















OE

VOLVO

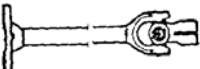
240 Kombi/Estate/Break (P245)

08.74 - 08.93



<p> Trag-/Führungsgelenk / Support-/ Steering Link</p> <table border="1"> <tr><td>2.0, 71 kW</td><td>08.80 - 12.84</td></tr> <tr><td>2.0, 76 kW</td><td>08.84 - 07.85</td></tr> <tr><td>2.1, 80 kW</td><td>08.80 - 07.84</td></tr> <tr><td>2.1 Turbo</td><td>08.80 - 07.85</td></tr> <tr><td>2.3, 81 kW</td><td>08.84 - 07.86</td></tr> <tr><td>2.3, 82 kW</td><td>08.80 - 07.84</td></tr> <tr><td>2.3, 96 kW</td><td>08.84 - 07.85</td></tr> <tr><td>2.3, 98 kW</td><td>08.84 - 12.88</td></tr> <tr><td>2.3, 100 kW</td><td>01.83 - 12.84</td></tr> <tr><td>2.4 Diesel, 60 kW</td><td>04.79 - 08.93</td></tr> </table>	2.0, 71 kW	08.80 - 12.84	2.0, 76 kW	08.84 - 07.85	2.1, 80 kW	08.80 - 07.84	2.1 Turbo	08.80 - 07.85	2.3, 81 kW	08.84 - 07.86	2.3, 82 kW	08.80 - 07.84	2.3, 96 kW	08.84 - 07.85	2.3, 98 kW	08.84 - 12.88	2.3, 100 kW	01.83 - 12.84	2.4 Diesel, 60 kW	04.79 - 08.93	<p> </p>	<p>12016 274 119</p> 																		
2.0, 71 kW	08.80 - 12.84																																							
2.0, 76 kW	08.84 - 07.85																																							
2.1, 80 kW	08.80 - 07.84																																							
2.1 Turbo	08.80 - 07.85																																							
2.3, 81 kW	08.84 - 07.86																																							
2.3, 82 kW	08.80 - 07.84																																							
2.3, 96 kW	08.84 - 07.85																																							
2.3, 98 kW	08.84 - 12.88																																							
2.3, 100 kW	01.83 - 12.84																																							
2.4 Diesel, 60 kW	04.79 - 08.93																																							
<p>Lagerung, Lenker / Mounting, wishbone</p> <table border="1"> <tr><td>2.0, 60 kW</td><td>08.74 - 07.75</td></tr> <tr><td>2.0, 66 kW</td><td>08.76 - 01.82</td></tr> <tr><td>2.0, 71 kW</td><td>08.80 - 12.84</td></tr> <tr><td>2.0, 76 kW</td><td>08.84 - 07.85</td></tr> <tr><td>2.0, 86 kW</td><td>08.83 - 07.93</td></tr> <tr><td>2.1, 71 kW</td><td>08.74 - 07.75</td></tr> <tr><td>2.1, 74 kW</td><td>08.75 - 07.80</td></tr> <tr><td>2.1, 80 kW</td><td>08.80 - 07.84</td></tr> <tr><td>2.1, 90 kW</td><td>08.74 - 07.79</td></tr> <tr><td>2.1 Turbo</td><td>08.80 - 07.85</td></tr> <tr><td>2.3, 81 kW</td><td>08.84 - 07.86</td></tr> <tr><td>2.3, 82 kW</td><td>08.80 - 07.84</td></tr> <tr><td>2.3, 83 kW</td><td>08.86 - 07.87</td></tr> <tr><td>2.3 i KAT</td><td>08.86 - 07.93</td></tr> <tr><td>2.3, 96 kW</td><td>08.84 - 07.85</td></tr> <tr><td>2.3, 98 kW</td><td>08.84 - 12.88</td></tr> <tr><td>2.3, 100 kW</td><td>01.83 - 12.84</td></tr> <tr><td>2.7 GLT6</td><td>08.79 - 07.80</td></tr> <tr><td>2.4 Diesel</td><td>04.79 - 08.93</td></tr> </table>	2.0, 60 kW	08.74 - 07.75	2.0, 66 kW	08.76 - 01.82	2.0, 71 kW	08.80 - 12.84	2.0, 76 kW	08.84 - 07.85	2.0, 86 kW	08.83 - 07.93	2.1, 71 kW	08.74 - 07.75	2.1, 74 kW	08.75 - 07.80	2.1, 80 kW	08.80 - 07.84	2.1, 90 kW	08.74 - 07.79	2.1 Turbo	08.80 - 07.85	2.3, 81 kW	08.84 - 07.86	2.3, 82 kW	08.80 - 07.84	2.3, 83 kW	08.86 - 07.87	2.3 i KAT	08.86 - 07.93	2.3, 96 kW	08.84 - 07.85	2.3, 98 kW	08.84 - 12.88	2.3, 100 kW	01.83 - 12.84	2.7 GLT6	08.79 - 07.80	2.4 Diesel	04.79 - 08.93	<p>  </p>	<p>11756 1 273 778</p> 
2.0, 60 kW	08.74 - 07.75																																							
2.0, 66 kW	08.76 - 01.82																																							
2.0, 71 kW	08.80 - 12.84																																							
2.0, 76 kW	08.84 - 07.85																																							
2.0, 86 kW	08.83 - 07.93																																							
2.1, 71 kW	08.74 - 07.75																																							
2.1, 74 kW	08.75 - 07.80																																							
2.1, 80 kW	08.80 - 07.84																																							
2.1, 90 kW	08.74 - 07.79																																							
2.1 Turbo	08.80 - 07.85																																							
2.3, 81 kW	08.84 - 07.86																																							
2.3, 82 kW	08.80 - 07.84																																							
2.3, 83 kW	08.86 - 07.87																																							
2.3 i KAT	08.86 - 07.93																																							
2.3, 96 kW	08.84 - 07.85																																							
2.3, 98 kW	08.84 - 12.88																																							
2.3, 100 kW	01.83 - 12.84																																							
2.7 GLT6	08.79 - 07.80																																							
2.4 Diesel	04.79 - 08.93																																							
<p>Lagerung, Lenker / Mounting, wishbone</p> <table border="1"> <tr><td>2.0, 60 kW</td><td>08.74 - 07.75</td></tr> <tr><td>2.0, 66 kW</td><td>08.76 - 01.82</td></tr> <tr><td>2.0, 71 kW</td><td>08.80 - 12.84</td></tr> <tr><td>2.0, 76 kW</td><td>08.84 - 07.85</td></tr> <tr><td>2.0, 86 kW</td><td>08.83 - 07.93</td></tr> <tr><td>2.1, 71 kW</td><td>08.74 - 07.75</td></tr> <tr><td>2.1, 74 kW</td><td>08.75 - 07.80</td></tr> <tr><td>2.1, 80 kW</td><td>08.80 - 07.84</td></tr> <tr><td>2.1, 90 kW</td><td>08.74 - 07.79</td></tr> <tr><td>2.1 Turbo</td><td>08.80 - 07.85</td></tr> <tr><td>2.3, 81 kW</td><td>08.84 - 07.86</td></tr> <tr><td>2.3, 82 kW</td><td>08.80 - 07.84</td></tr> <tr><td>2.3, 83 kW</td><td>08.86 - 07.87</td></tr> <tr><td>2.3 i KAT</td><td>08.86 - 07.93</td></tr> <tr><td>2.3, 96 kW</td><td>08.84 - 07.85</td></tr> <tr><td>2.3, 98 kW</td><td>08.84 - 12.88</td></tr> <tr><td>2.3, 100 kW</td><td>01.83 - 12.84</td></tr> <tr><td>2.4 Diesel</td><td>04.79 - 08.93</td></tr> </table>	2.0, 60 kW	08.74 - 07.75	2.0, 66 kW	08.76 - 01.82	2.0, 71 kW	08.80 - 12.84	2.0, 76 kW	08.84 - 07.85	2.0, 86 kW	08.83 - 07.93	2.1, 71 kW	08.74 - 07.75	2.1, 74 kW	08.75 - 07.80	2.1, 80 kW	08.80 - 07.84	2.1, 90 kW	08.74 - 07.79	2.1 Turbo	08.80 - 07.85	2.3, 81 kW	08.84 - 07.86	2.3, 82 kW	08.80 - 07.84	2.3, 83 kW	08.86 - 07.87	2.3 i KAT	08.86 - 07.93	2.3, 96 kW	08.84 - 07.85	2.3, 98 kW	08.84 - 12.88	2.3, 100 kW	01.83 - 12.84	2.4 Diesel	04.79 - 08.93	<p>  </p>	<p>12032 1 205 825</p> 		
2.0, 60 kW	08.74 - 07.75																																							
2.0, 66 kW	08.76 - 01.82																																							
2.0, 71 kW	08.80 - 12.84																																							
2.0, 76 kW	08.84 - 07.85																																							
2.0, 86 kW	08.83 - 07.93																																							
2.1, 71 kW	08.74 - 07.75																																							
2.1, 74 kW	08.75 - 07.80																																							
2.1, 80 kW	08.80 - 07.84																																							
2.1, 90 kW	08.74 - 07.79																																							
2.1 Turbo	08.80 - 07.85																																							
2.3, 81 kW	08.84 - 07.86																																							
2.3, 82 kW	08.80 - 07.84																																							
2.3, 83 kW	08.86 - 07.87																																							
2.3 i KAT	08.86 - 07.93																																							
2.3, 96 kW	08.84 - 07.85																																							
2.3, 98 kW	08.84 - 12.88																																							
2.3, 100 kW	01.83 - 12.84																																							
2.4 Diesel	04.79 - 08.93																																							
<p>Lenkwelle / Steering Shaft fahrerseitig / Driver side</p> <table border="1"> <tr><td>2.0, 71 kW</td><td>08.80 - 12.84</td></tr> <tr><td>2.0, 76 kW</td><td>08.84 - 07.85</td></tr> <tr><td>2.1, 80 kW</td><td>08.80 - 07.84</td></tr> <tr><td>2.1 Turbo</td><td>08.80 - 07.85</td></tr> <tr><td>2.3, 81 kW</td><td>08.84 - 07.86</td></tr> <tr><td>2.3, 82 kW</td><td>08.80 - 07.84</td></tr> <tr><td>2.3, 96 kW</td><td>08.84 - 07.85</td></tr> <tr><td>2.3, 98 kW</td><td>08.84 - 12.88</td></tr> <tr><td>2.3, 100 kW</td><td>01.83 - 12.84</td></tr> <tr><td>2.4 Diesel, 60 kW</td><td>04.79 - 08.93</td></tr> </table>	2.0, 71 kW	08.80 - 12.84	2.0, 76 kW	08.84 - 07.85	2.1, 80 kW	08.80 - 07.84	2.1 Turbo	08.80 - 07.85	2.3, 81 kW	08.84 - 07.86	2.3, 82 kW	08.80 - 07.84	2.3, 96 kW	08.84 - 07.85	2.3, 98 kW	08.84 - 12.88	2.3, 100 kW	01.83 - 12.84	2.4 Diesel, 60 kW	04.79 - 08.93		<p>20382</p> 																		
2.0, 71 kW	08.80 - 12.84																																							
2.0, 76 kW	08.84 - 07.85																																							
2.1, 80 kW	08.80 - 07.84																																							
2.1 Turbo	08.80 - 07.85																																							
2.3, 81 kW	08.84 - 07.86																																							
2.3, 82 kW	08.80 - 07.84																																							
2.3, 96 kW	08.84 - 07.85																																							
2.3, 98 kW	08.84 - 12.88																																							
2.3, 100 kW	01.83 - 12.84																																							
2.4 Diesel, 60 kW	04.79 - 08.93																																							
<p>Faltenbalgsatz, Lenkung / Bellow Kit, steering system</p> <p>ALL TYPES ausser/except for :</p> <table border="1"> <tr><td>2.0, 100 kW</td><td>10.82 - 08.84</td></tr> <tr><td>2.1</td><td>01.74 - 08.84</td></tr> <tr><td>2.3</td><td>01.82 - 08.84</td></tr> </table>	2.0, 100 kW	10.82 - 08.84	2.1	01.74 - 08.84	2.3	01.82 - 08.84	<p></p>	<p>30185 1 272 925</p> 																																
2.0, 100 kW	10.82 - 08.84																																							
2.1	01.74 - 08.84																																							
2.3	01.82 - 08.84																																							
<p>Faltenbalgsatz, Lenkung / Bellow Kit, steering system</p> <p>ALL TYPES ausser/except for :</p> <table border="1"> <tr><td>2.0, 100 kW</td><td>10.82 - 08.84</td></tr> <tr><td>2.1</td><td>01.74 - 08.84</td></tr> <tr><td>2.3</td><td>01.82 - 08.84</td></tr> </table>	2.0, 100 kW	10.82 - 08.84	2.1	01.74 - 08.84	2.3	01.82 - 08.84	<p></p>	<p>30186 1 272 924</p> 																																
2.0, 100 kW	10.82 - 08.84																																							
2.1	01.74 - 08.84																																							
2.3	01.82 - 08.84																																							



VOLVO









240 Kombi/Estate/Break (P245)

08.74 - 08.93

	Lagerung, Panhardstab / Suspension, panhard rod		20130	1 330 973
	2.0, 60 kW 2.0, 66 kW 2.0, 71 kW 2.0, 76 kW 2.0, 86 kW 2.1, 71 kW 2.1, 74 kW 2.1, 79 kW 2.1, 80 kW 2.1, 90 kW 2.1 Turbo 2.3, 81 kW 2.3, 82 kW 2.3, 83 kW 2.3 i KAT 2.3, 96 kW 2.3, 98 kW 2.3, 100 kW 2.7 GLT6 2.4 Diesel		08.74 - 07.75 08.76 - 01.82 08.80 - 12.84 08.84 - 07.85 08.83 - 07.93 08.74 - 07.75 08.75 - 07.80 08.80 - 07.84 08.80 - 07.84 08.74 - 07.79 08.80 - 07.85 08.84 - 07.86 08.80 - 07.84 08.86 - 07.87 08.86 - 07.93 08.84 - 07.85 08.84 - 12.88 01.83 - 12.84 08.79 - 07.80 04.79 - 08.93	





340-360 (343, 345)

08.75 - 07.91

	Spurstangenkopf / Tie-rod End Innengewinde [mm] / Inner Thread [mm]:M14x1,5 Gewindeart: mit Rechtsgewinde / Thread Type: with right-hand thread Konusmaß [mm] / Cone Size [mm]:14		20143	3 211 955
	ALL TYPES			
	Axialgelenk, Spurstange / Axial Rod, tie rod Gewindemaß / Thread Size:M14x1,5 Gewindeart: mit Rechtsgewinde / Thread Type: with right-hand thread Achsausführung / Axle Version:CAM		12018	3 293 736
	ALL TYPES			
	Axialgelenk, Spurstange / Axial Rod, tie rod für / for:ZF Gewindemaß / Thread Size:M14x1,5 Gewindeart: mit Rechtsgewinde / Thread Type: with right-hand thread Achsausführung / Axle Version:ZF		20144	3 268 829
	ALL TYPES			
	Trag-/Führungsgelenk / Support-/ Steering Link		12017	3 211 956
	ALL TYPES			

340-360 Stufenheck/Saloon/avec coffre (344)

08.79 - 07.91

	Spurstangenkopf / Tie-rod End Innengewinde [mm] / Inner Thread [mm]:M14x1,5 Gewindeart: mit Rechtsgewinde / Thread Type: with right-hand thread Konusmaß [mm] / Cone Size [mm]:14		20143	3 211 955
	ALL TYPES			
	Axialgelenk, Spurstange / Axial Rod, tie rod Gewindemaß / Thread Size:M14x1,5 Gewindeart: mit Rechtsgewinde / Thread Type: with right-hand thread Achsausführung / Axle Version:CAM		12018	3 293 736
	ALL TYPES			







OE

VOLVO

340-360 Stufenheck/Saloon/avec coffre (344)







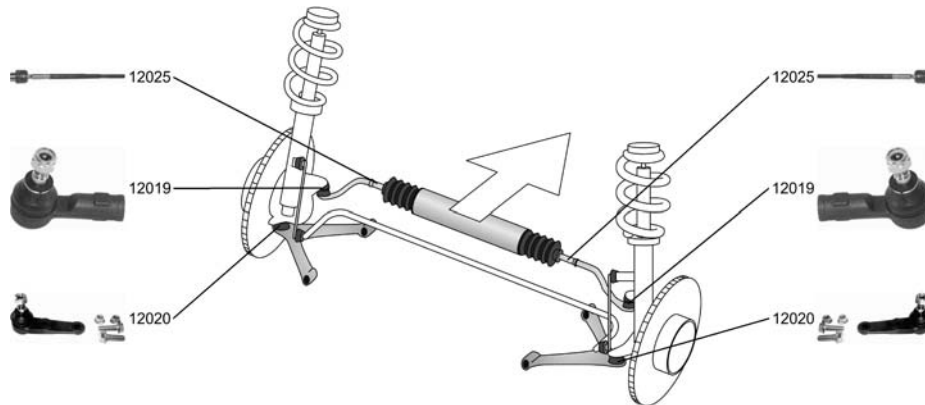

08.79 - 07.91

 Axialgelenk, Spurstange / Axial Rod, tie rod für / for:ZF Gewindemaß / Thread Size:M14x1,5 Gewindeart: mit Rechtsgewinde / Thread Type: with right-hand thread Achsausführung / Axle Version:ZF ALL TYPES		20144 3 268 829 
Trag-/Führungsgelenk / Support-/ Steering Link ALL TYPES		12017 3 211 956 

440 K (445)

08.88 - 12.96



Spurstangenkopf / Tie-rod End Innengewinde [mm] / Inner Thread [mm]:M12x1,25 Gewindeart: mit Rechtsgewinde / Thread Type: with right-hand thread Gewindemaß / Thread Size:M12x1,25 Konusmaß [mm] / Cone Size [mm]:14 ALL TYPES		12019 3 480 012 
Axialgelenk, Spurstange / Axial Rod, tie rod Gewindemaß / Thread Size:M14x1,5 Gewindeart: mit Rechtsgewinde / Thread Type: with right-hand thread ALL TYPES		12025 3 410 369 
Trag-/Führungsgelenk / Support-/ Steering Link mit Befestigungsmaterial / with fastening material ALL TYPES		12020 3 465 482 
Faltenbalgsatz, Lenkung / Bellow Kit, steering system 1.6 09.88 - 12.96 1.7 08.88 - 12.96 1.7 Turbo 08.88 - 12.96 1.8, 1794 ccm 08.91 - 07.96 2.0 08.92 - 07.96 1.9 Turbo-Diesel 07.94 - 12.96 1.8, 1783 ccm 09.95 - 12.96	LHD 	30187 3 343 641 







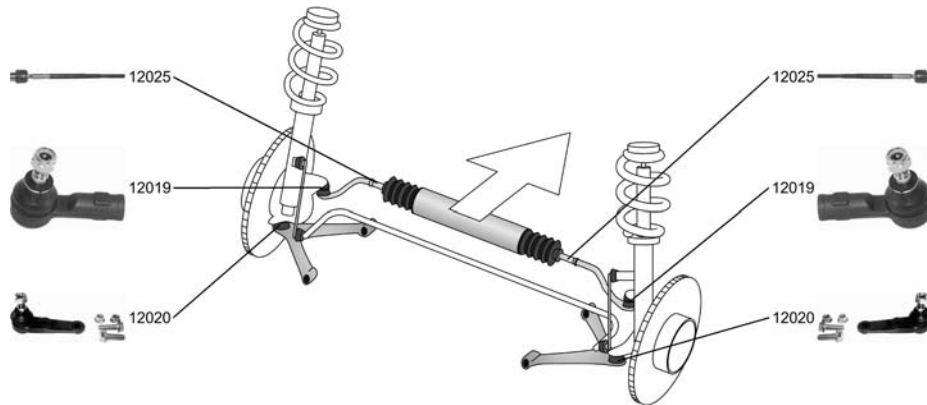

VOLVO

460 L (464)

09.88 - 07.96





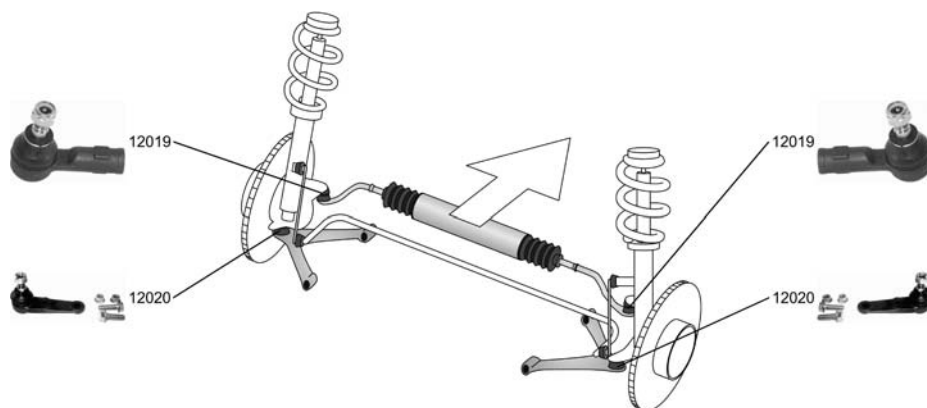

<p>Spurstangenkopf / Tie-rod End Innengewinde [mm] / Inner Thread [mm]:M12x1,25 Gewindeart: mit Rechtsgewinde / Thread Type: with right-hand thread Gewindemaß / Thread Size:M12x1,25 Konusmaß [mm] / Cone Size [mm]:14 ALL TYPES</p>		<p>12019 3 480 012</p> 
<p>Axialgelenk, Spurstange / Axial Rod, tie rod Gewindemaß / Thread Size:M14x1,5 Gewindeart: mit Rechtsgewinde / Thread Type: with right-hand thread ALL TYPES</p>		<p>12025 3 410 369</p> 
<p>Trag-/Führungsgelenk / Support-/ Steering Link mit Befestigungsmaterial / with fastening material ALL TYPES</p>		<p>12020 3 465 482</p> 

480 E

04.86 - 07.96



<p>Spurstangenkopf / Tie-rod End Innengewinde [mm] / Inner Thread [mm]:M12x1,25 Gewindeart: mit Rechtsgewinde / Thread Type: with right-hand thread Gewindemaß / Thread Size:M12x1,25 Konusmaß [mm] / Cone Size [mm]:14 ALL TYPES</p>		<p>12019 3 480 012</p> 
<p>Trag-/Führungsgelenk / Support-/ Steering Link mit Befestigungsmaterial / with fastening material ALL TYPES</p>		<p>12020 3 465 482</p> 







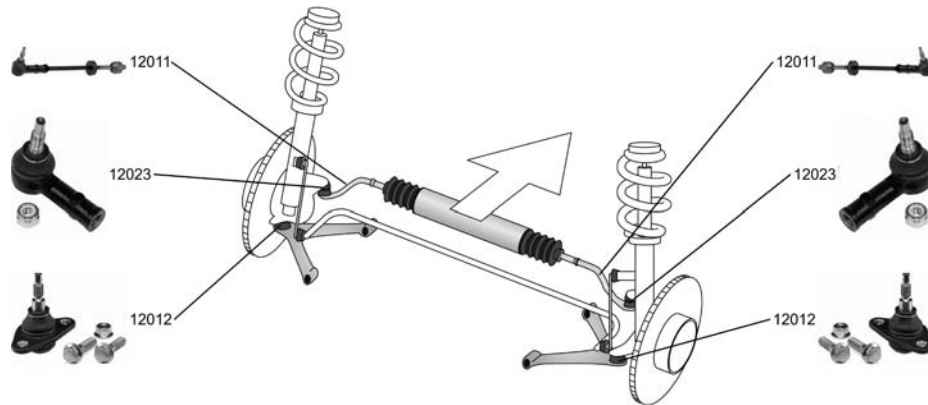

OE

VOLVO

740 (744)

08.83 - 08.92











<p>Spurstange / Tie Rod, steering Achsausführung / Axle Version:ZF Rohr-Ø [mm] / Pipe Ø [mm]:12 Konusmaß [mm] / Cone Size [mm]:14 Gewindeart: mit Rechtsgewinde / Thread Type: with right-hand thread</p>		<p>12011 271 389</p> 																																
<table border="0"> <tbody> <tr><td>2.0, 89 kW</td><td>08.85 - 07.92</td></tr> <tr><td>2.3, 83 kW</td><td>09.85 - 12.89</td></tr> <tr><td>2.3, 84 kW</td><td>08.84 - 07.90</td></tr> <tr><td>2.3, 85 kW</td><td>08.87 - 07.92</td></tr> <tr><td>2.3, 86 kW</td><td>08.86 - 07.88</td></tr> <tr><td>2.3, 95 kW</td><td>08.83 - 07.84</td></tr> <tr><td>2.3, 96 kW</td><td>08.84 - 07.88</td></tr> <tr><td>2.3, 100 kW</td><td>08.88 - 07.90</td></tr> <tr><td>2.3, 111 kW</td><td>08.88 - 08.92</td></tr> <tr><td>2.3, 114 kW</td><td>08.88 - 07.91</td></tr> <tr><td>2.3 Turbo, 115 kW</td><td>08.86 - 07.89</td></tr> <tr><td>2.3, 117 kW</td><td>08.87 - 07.89</td></tr> <tr><td>2.3 Turbo, 121 kW</td><td>08.89 - 07.90</td></tr> <tr><td>2.3 Turbo, 140 kW</td><td>08.89 - 07.90</td></tr> <tr><td>2.4 Diesel</td><td>08.84 - 07.92</td></tr> <tr><td>2.4 TD, 83 kW</td><td>08.84 - 07.90</td></tr> </tbody> </table>	2.0, 89 kW	08.85 - 07.92	2.3, 83 kW	09.85 - 12.89	2.3, 84 kW	08.84 - 07.90	2.3, 85 kW	08.87 - 07.92	2.3, 86 kW	08.86 - 07.88	2.3, 95 kW	08.83 - 07.84	2.3, 96 kW	08.84 - 07.88	2.3, 100 kW	08.88 - 07.90	2.3, 111 kW	08.88 - 08.92	2.3, 114 kW	08.88 - 07.91	2.3 Turbo, 115 kW	08.86 - 07.89	2.3, 117 kW	08.87 - 07.89	2.3 Turbo, 121 kW	08.89 - 07.90	2.3 Turbo, 140 kW	08.89 - 07.90	2.4 Diesel	08.84 - 07.92	2.4 TD, 83 kW	08.84 - 07.90		
2.0, 89 kW	08.85 - 07.92																																	
2.3, 83 kW	09.85 - 12.89																																	
2.3, 84 kW	08.84 - 07.90																																	
2.3, 85 kW	08.87 - 07.92																																	
2.3, 86 kW	08.86 - 07.88																																	
2.3, 95 kW	08.83 - 07.84																																	
2.3, 96 kW	08.84 - 07.88																																	
2.3, 100 kW	08.88 - 07.90																																	
2.3, 111 kW	08.88 - 08.92																																	
2.3, 114 kW	08.88 - 07.91																																	
2.3 Turbo, 115 kW	08.86 - 07.89																																	
2.3, 117 kW	08.87 - 07.89																																	
2.3 Turbo, 121 kW	08.89 - 07.90																																	
2.3 Turbo, 140 kW	08.89 - 07.90																																	
2.4 Diesel	08.84 - 07.92																																	
2.4 TD, 83 kW	08.84 - 07.90																																	
<p>Spurstangenkopf / Tie-rod End Konusmaß [mm] / Cone Size [mm]:14 Gewindeart: mit Rechtsgewinde / Thread Type: with right-hand thread Innengewinde [mm] / Inner Thread [mm]:M14x2 Gewindemaß / Thread Size:M14x2 für Lenkgetriebe-ID / For steering rack ID:ZF/CAM/TRW</p>		<p>12023 3 516 944</p> 																																
<table border="0"> <tbody> <tr><td>2.0</td><td>12.83 - 07.92</td></tr> <tr><td>2.3</td><td>08.83 - 08.92</td></tr> <tr><td>2.3 Turbo</td><td>08.85 - 07.90</td></tr> <tr><td>2.4 Diesel</td><td>08.84 - 07.92</td></tr> <tr><td>2.4 TD</td><td>08.84 - 07.90</td></tr> </tbody> </table>	2.0	12.83 - 07.92	2.3	08.83 - 08.92	2.3 Turbo	08.85 - 07.90	2.4 Diesel	08.84 - 07.92	2.4 TD	08.84 - 07.90																								
2.0	12.83 - 07.92																																	
2.3	08.83 - 08.92																																	
2.3 Turbo	08.85 - 07.90																																	
2.4 Diesel	08.84 - 07.92																																	
2.4 TD	08.84 - 07.90																																	
<p>Axialgelenk, Spurstange / Axial Rod, tie rod</p>		<p>12008 1 359 347</p> 																																
<table border="0"> <tbody> <tr><td>2.0, 89 kW</td><td>08.85 - 07.92</td></tr> <tr><td>2.3, 83 kW</td><td>09.85 - 12.89</td></tr> <tr><td>2.3, 84 kW</td><td>08.84 - 07.90</td></tr> <tr><td>2.3, 85 kW</td><td>08.87 - 07.92</td></tr> <tr><td>2.3, 86 kW</td><td>08.86 - 07.88</td></tr> <tr><td>2.3, 95 kW</td><td>08.83 - 07.84</td></tr> <tr><td>2.3, 96 kW</td><td>08.84 - 07.88</td></tr> <tr><td>2.3, 100 kW</td><td>08.88 - 07.90</td></tr> <tr><td>2.3, 111 kW</td><td>08.88 - 08.92</td></tr> <tr><td>2.3, 114 kW</td><td>08.88 - 07.91</td></tr> <tr><td>2.3 Turbo, 115 kW</td><td>08.86 - 07.89</td></tr> <tr><td>2.3, 117 kW</td><td>08.87 - 07.89</td></tr> <tr><td>2.3 Turbo, 121 kW</td><td>08.89 - 07.90</td></tr> <tr><td>2.3 Turbo, 140 kW</td><td>08.89 - 07.90</td></tr> <tr><td>2.4 Diesel</td><td>08.84 - 07.92</td></tr> <tr><td>2.4 TD, 83 kW</td><td>08.84 - 07.90</td></tr> </tbody> </table>	2.0, 89 kW	08.85 - 07.92	2.3, 83 kW	09.85 - 12.89	2.3, 84 kW	08.84 - 07.90	2.3, 85 kW	08.87 - 07.92	2.3, 86 kW	08.86 - 07.88	2.3, 95 kW	08.83 - 07.84	2.3, 96 kW	08.84 - 07.88	2.3, 100 kW	08.88 - 07.90	2.3, 111 kW	08.88 - 08.92	2.3, 114 kW	08.88 - 07.91	2.3 Turbo, 115 kW	08.86 - 07.89	2.3, 117 kW	08.87 - 07.89	2.3 Turbo, 121 kW	08.89 - 07.90	2.3 Turbo, 140 kW	08.89 - 07.90	2.4 Diesel	08.84 - 07.92	2.4 TD, 83 kW	08.84 - 07.90		
2.0, 89 kW	08.85 - 07.92																																	
2.3, 83 kW	09.85 - 12.89																																	
2.3, 84 kW	08.84 - 07.90																																	
2.3, 85 kW	08.87 - 07.92																																	
2.3, 86 kW	08.86 - 07.88																																	
2.3, 95 kW	08.83 - 07.84																																	
2.3, 96 kW	08.84 - 07.88																																	
2.3, 100 kW	08.88 - 07.90																																	
2.3, 111 kW	08.88 - 08.92																																	
2.3, 114 kW	08.88 - 07.91																																	
2.3 Turbo, 115 kW	08.86 - 07.89																																	
2.3, 117 kW	08.87 - 07.89																																	
2.3 Turbo, 121 kW	08.89 - 07.90																																	
2.3 Turbo, 140 kW	08.89 - 07.90																																	
2.4 Diesel	08.84 - 07.92																																	
2.4 TD, 83 kW	08.84 - 07.90																																	



VOLVO

740 (744)

08.83 - 08.92

<p> Axialgelenk, Spurstange / Axial Rod, tie rod Achsausführung / Axle Version:CAM Gewindemaß / Thread Size:M14x2 Gewindeart: mit Rechtsgewinde / Thread Type: with right-hand thread</p>		<p>20133 9 140 504</p> 
<p>2.0, 89 kW 2.3, 83 kW 2.3, 84 kW 2.3, 85 kW 2.3 Turbo, 115 kW 2.3, 117 kW 2.4 Diesel 2.4 TD, 83 kW</p>	<p>08.85 - 07.92 09.85 - 12.89 08.84 - 07.90 08.87 - 07.92 08.86 - 07.89 08.87 - 07.89 08.84 - 07.92 08.84 - 07.90</p>	<p>08.1988-></p>
<p>2.0, 89 kW 2.3, 83 kW 2.3, 84 kW 2.3, 85 kW 2.3 Turbo, 115 kW 2.3, 117 kW 2.4 Diesel 2.4 TD, 83 kW</p>	<p>08.85 - 07.92 09.85 - 12.89 08.84 - 07.90 08.87 - 07.92 08.86 - 07.89 08.87 - 07.89 08.84 - 07.92 08.84 - 07.90</p>	
<p>2.3, 86 kW 2.3, 96 kW 2.3, 100 kW 2.3, 111 kW 2.3, 114 kW 2.3 Turbo, 121 kW 2.3 Turbo, 140 kW</p>	<p>08.86 - 07.88 08.84 - 07.88 08.88 - 07.90 08.88 - 08.92 08.88 - 07.91 08.89 - 07.90 08.89 - 07.90</p>	
<p>Trag-/Führungsgelenk / Support-/ Steering Link mit Befestigungsmaterial / with fastening material</p>		<p>12012 270 477</p> 
<p>2.0, 89 kW 2.3, 83 kW 2.3, 84 kW 2.3, 85 kW 2.3, 86 kW 2.3, 95 kW 2.3, 96 kW 2.3, 100 kW 2.3, 111 kW 2.3, 114 kW 2.3 Turbo, 115 kW 2.3, 117 kW 2.3 Turbo, 121 kW 2.3 Turbo, 140 kW 2.4 Diesel 2.4 TD, 83 kW</p>	<p>08.85 - 07.92 09.85 - 12.89 08.84 - 07.90 08.87 - 07.92 08.86 - 07.88 08.83 - 07.84 08.84 - 07.88 08.88 - 07.90 08.88 - 08.92 08.88 - 07.91 08.86 - 07.89 08.87 - 07.89 08.89 - 07.90 08.89 - 07.90 08.84 - 07.92 08.84 - 07.90</p>	
<p>Lagerung, Lenker / Mounting, wishbone</p> <p>2.0, 89 kW 2.3, 83 kW 2.3, 84 kW 2.3, 85 kW 2.3, 86 kW 2.3, 95 kW 2.3, 96 kW 2.3, 100 kW 2.3, 111 kW 2.3, 114 kW 2.3 Turbo, 115 kW 2.3, 117 kW 2.3 Turbo, 121 kW 2.3 Turbo, 140 kW 2.4 Diesel 2.4 TD, 83 kW</p>		<p>12037 1 359 599</p> 
<p>Achsstrebenlager / Mounting, axle strut</p> <p>2.3, 85 kW 2.3, 96 kW 2.3, 100 kW 2.3, 114 kW 2.3 Turbo, 115 kW 2.3 Turbo, 121 kW 2.3 Turbo, 140 kW 2.4 Diesel</p>		<p>20128 1 329 655</p> 

















OE

VOLVO

740 (744)





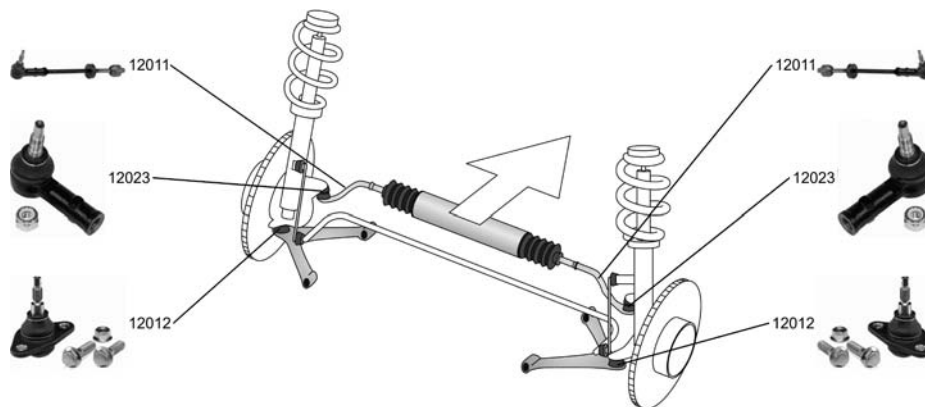

08.83 - 08.92

	Faltenbalgsatz, Lenkung / Bellow Kit, steering system		30185	1 272 925
	2.0 12.83 - 07.92 2.3 08.83 - 08.92 2.3 Turbo 08.85 - 07.90 2.4 Diesel 08.84 - 07.92 2.4 TD 08.84 - 07.90			
	Faltenbalgsatz, Lenkung / Bellow Kit, steering system		30186	1 272 924
	2.0 12.83 - 07.92 2.3 08.83 - 08.92 2.3 Turbo 08.85 - 07.90 2.4 Diesel 08.84 - 07.92 2.4 TD 08.84 - 07.90			
	Lagerung, Lenker / Mounting, wishbone		20123	1 272 306
	2.0 12.83 - 07.92 2.3 08.83 - 08.92 2.3 Turbo 08.85 - 07.90 2.4 Diesel 08.84 - 07.92 2.4 TD 08.84 - 07.90			
	Stabilisatorlager / Mounting, Stabilizer		20120	1 229 608
	2.0 12.83 - 07.92 2.3 08.83 - 08.92 2.3 Turbo 08.85 - 07.90 2.4 Diesel 08.84 - 07.92 2.4 TD 08.84 - 07.90			
	Lagerung, Panhardstab / Suspension, panhard rod		20130	1 330 973
	2.0 12.83 - 07.92 2.3 08.83 - 08.92 2.3 Turbo 08.85 - 07.90 2.4 Diesel 08.84 - 07.92 2.4 TD 08.84 - 07.90			

740 Kombi/Estate/Break (745)

08.85 - 08.92

















	Spurstange / Tie Rod, steering Achsausführung / Axle Version:ZF Rohr-Ø [mm] / Pipe Ø [mm]:12 Konusmaß [mm] / Cone Size [mm]:14 Gewindeart: mit Rechtsgewinde / Thread Type: with right-hand thread		12011	271 389
	ALL TYPES ausser/except for : 2.0, 76 kW 09.88 - 08.90 2.0, 86 kW 01.87 - 08.88 2.3, 82 kW 08.85 - 07.86			
	Spurstangenkopf / Tie-rod End Konusmaß [mm] / Cone Size [mm]:14 Gewindeart: mit Rechtsgewinde / Thread Type: with right-hand thread Innengewinde [mm] / Inner Thread [mm]:M14x2 Gewindemaß / Thread Size:M14x2 für Lenkgetriebe-ID / For steering rack ID:ZF/CAM/TRW		12023	3 516 944
	ALL TYPES			



VOLVO

740 Kombi/Estate/Break (745)

08.85 - 08.92

<p> Axialgelenk, Spurstange / Axial Rod, tie rod</p> <p>ALL TYPES ausser/except for :</p> <table border="1"> <tr><td>2.0, 76 kW</td><td>09.88 - 08.90</td></tr> <tr><td>2.0, 86 kW</td><td>01.87 - 08.88</td></tr> <tr><td>2.3, 82 kW</td><td>08.85 - 07.86</td></tr> </table>	2.0, 76 kW	09.88 - 08.90	2.0, 86 kW	01.87 - 08.88	2.3, 82 kW	08.85 - 07.86	<p></p>	<p>12008 1 359 347</p> <p></p>																												
2.0, 76 kW	09.88 - 08.90																																			
2.0, 86 kW	01.87 - 08.88																																			
2.3, 82 kW	08.85 - 07.86																																			
<p>Axialgelenk, Spurstange / Axial Rod, tie rod Achsausführung / Axle Version:CAM Gewindemaß / Thread Size:M14x2 Gewindeart: mit Rechtsgewinde / Thread Type: with right-hand thread</p> <table border="1"> <tr><td>2.0, 89 kW</td><td>08.85 - 07.92</td></tr> <tr><td>2.3, 83 kW</td><td>08.85 - 12.89</td></tr> <tr><td>2.3, 84 kW</td><td>09.85 - 07.90</td></tr> <tr><td>2.3, 85 kW</td><td>08.87 - 07.92</td></tr> <tr><td>2.3 Turbo, 115 kW</td><td>08.86 - 07.89</td></tr> <tr><td>2.3, 117 kW</td><td>08.87 - 07.89</td></tr> <tr><td>2.4 Turbo-Diesel</td><td>09.85 - 07.92</td></tr> </table> <table border="1"> <tr><td>2.0, 82 kW</td><td>08.89 - 07.91</td></tr> <tr><td>2.3, 96 kW</td><td>08.85 - 07.88</td></tr> <tr><td>2.3, 100 kW</td><td>08.89 - 07.90</td></tr> <tr><td>2.3, 111 kW</td><td>07.89 - 08.92</td></tr> <tr><td>2.3, 114 kW</td><td>08.88 - 07.90</td></tr> <tr><td>2.3 Turbo, 121 kW</td><td>08.89 - 07.90</td></tr> <tr><td>2.3 Turbo, 134 kW</td><td>08.85 - 07.88</td></tr> <tr><td>2.3 Turbo, 140 kW</td><td>08.89 - 07.90</td></tr> <tr><td>2.4 Diesel</td><td>08.85 - 07.88</td></tr> <tr><td>2.4 TD Interc.</td><td>08.86 - 07.88</td></tr> </table>	2.0, 89 kW	08.85 - 07.92	2.3, 83 kW	08.85 - 12.89	2.3, 84 kW	09.85 - 07.90	2.3, 85 kW	08.87 - 07.92	2.3 Turbo, 115 kW	08.86 - 07.89	2.3, 117 kW	08.87 - 07.89	2.4 Turbo-Diesel	09.85 - 07.92	2.0, 82 kW	08.89 - 07.91	2.3, 96 kW	08.85 - 07.88	2.3, 100 kW	08.89 - 07.90	2.3, 111 kW	07.89 - 08.92	2.3, 114 kW	08.88 - 07.90	2.3 Turbo, 121 kW	08.89 - 07.90	2.3 Turbo, 134 kW	08.85 - 07.88	2.3 Turbo, 140 kW	08.89 - 07.90	2.4 Diesel	08.85 - 07.88	2.4 TD Interc.	08.86 - 07.88	<p></p> <p>08.1988-></p>	<p>20133 9 140 504</p> <p></p>
2.0, 89 kW	08.85 - 07.92																																			
2.3, 83 kW	08.85 - 12.89																																			
2.3, 84 kW	09.85 - 07.90																																			
2.3, 85 kW	08.87 - 07.92																																			
2.3 Turbo, 115 kW	08.86 - 07.89																																			
2.3, 117 kW	08.87 - 07.89																																			
2.4 Turbo-Diesel	09.85 - 07.92																																			
2.0, 82 kW	08.89 - 07.91																																			
2.3, 96 kW	08.85 - 07.88																																			
2.3, 100 kW	08.89 - 07.90																																			
2.3, 111 kW	07.89 - 08.92																																			
2.3, 114 kW	08.88 - 07.90																																			
2.3 Turbo, 121 kW	08.89 - 07.90																																			
2.3 Turbo, 134 kW	08.85 - 07.88																																			
2.3 Turbo, 140 kW	08.89 - 07.90																																			
2.4 Diesel	08.85 - 07.88																																			
2.4 TD Interc.	08.86 - 07.88																																			
<p>Trag-/Führungsgelenk / Support-/ Steering Link mit Befestigungsmaterial / with fastening material</p> <p>ALL TYPES ausser/except for :</p> <table border="1"> <tr><td>2.0, 76 kW</td><td>09.88 - 08.90</td></tr> <tr><td>2.0, 86 kW</td><td>01.87 - 08.88</td></tr> <tr><td>2.3, 82 kW</td><td>08.85 - 07.86</td></tr> </table>	2.0, 76 kW	09.88 - 08.90	2.0, 86 kW	01.87 - 08.88	2.3, 82 kW	08.85 - 07.86	<p></p>	<p>12012 270 477</p> <p></p>																												
2.0, 76 kW	09.88 - 08.90																																			
2.0, 86 kW	01.87 - 08.88																																			
2.3, 82 kW	08.85 - 07.86																																			
<p>Lagerung, Lenker / Mounting, wishbone</p> <p>ALL TYPES ausser/except for :</p> <table border="1"> <tr><td>2.0, 76 kW</td><td>09.88 - 08.90</td></tr> <tr><td>2.0, 86 kW</td><td>01.87 - 08.88</td></tr> <tr><td>2.3, 82 kW</td><td>08.85 - 07.86</td></tr> </table>	2.0, 76 kW	09.88 - 08.90	2.0, 86 kW	01.87 - 08.88	2.3, 82 kW	08.85 - 07.86	<p></p>	<p>12037 1 359 599</p> <p></p>																												
2.0, 76 kW	09.88 - 08.90																																			
2.0, 86 kW	01.87 - 08.88																																			
2.3, 82 kW	08.85 - 07.86																																			
<p>Achsstrebenlager / Mounting, axle strut</p> <table border="1"> <tr><td>2.0, 82 kW</td><td>08.89 - 07.91</td></tr> <tr><td>2.3, 84 kW</td><td>09.85 - 07.90</td></tr> <tr><td>2.3, 85 kW</td><td>08.87 - 07.92</td></tr> <tr><td>2.3, 96 kW</td><td>08.85 - 07.88</td></tr> <tr><td>2.3, 100 kW</td><td>08.89 - 07.90</td></tr> <tr><td>2.3, 114 kW</td><td>08.88 - 07.90</td></tr> <tr><td>2.3 Turbo, 115 kW</td><td>08.86 - 07.89</td></tr> <tr><td>2.3 Turbo, 121 kW</td><td>08.89 - 07.90</td></tr> <tr><td>2.3 Turbo, 134 kW</td><td>08.85 - 07.88</td></tr> <tr><td>2.4 Diesel</td><td>08.85 - 07.88</td></tr> <tr><td>2.4 Turbo-Diesel</td><td>09.85 - 07.92</td></tr> <tr><td>2.4 TD Interc.</td><td>08.86 - 07.88</td></tr> </table>	2.0, 82 kW	08.89 - 07.91	2.3, 84 kW	09.85 - 07.90	2.3, 85 kW	08.87 - 07.92	2.3, 96 kW	08.85 - 07.88	2.3, 100 kW	08.89 - 07.90	2.3, 114 kW	08.88 - 07.90	2.3 Turbo, 115 kW	08.86 - 07.89	2.3 Turbo, 121 kW	08.89 - 07.90	2.3 Turbo, 134 kW	08.85 - 07.88	2.4 Diesel	08.85 - 07.88	2.4 Turbo-Diesel	09.85 - 07.92	2.4 TD Interc.	08.86 - 07.88	<p></p>	<p>20128 1 329 655</p> <p></p>										
2.0, 82 kW	08.89 - 07.91																																			
2.3, 84 kW	09.85 - 07.90																																			
2.3, 85 kW	08.87 - 07.92																																			
2.3, 96 kW	08.85 - 07.88																																			
2.3, 100 kW	08.89 - 07.90																																			
2.3, 114 kW	08.88 - 07.90																																			
2.3 Turbo, 115 kW	08.86 - 07.89																																			
2.3 Turbo, 121 kW	08.89 - 07.90																																			
2.3 Turbo, 134 kW	08.85 - 07.88																																			
2.4 Diesel	08.85 - 07.88																																			
2.4 Turbo-Diesel	09.85 - 07.92																																			
2.4 TD Interc.	08.86 - 07.88																																			
<p>Faltenbalgsatz, Lenkung / Bellow Kit, steering system ALL TYPES</p>	<p></p>	<p>30185 1 272 925</p> <p></p>																																		
<p>Faltenbalgsatz, Lenkung / Bellow Kit, steering system ALL TYPES</p>	<p></p>	<p>30186 1 272 924</p> <p></p>																																		









OE

VOLVO

740 Kombi/Estate/Break (745)





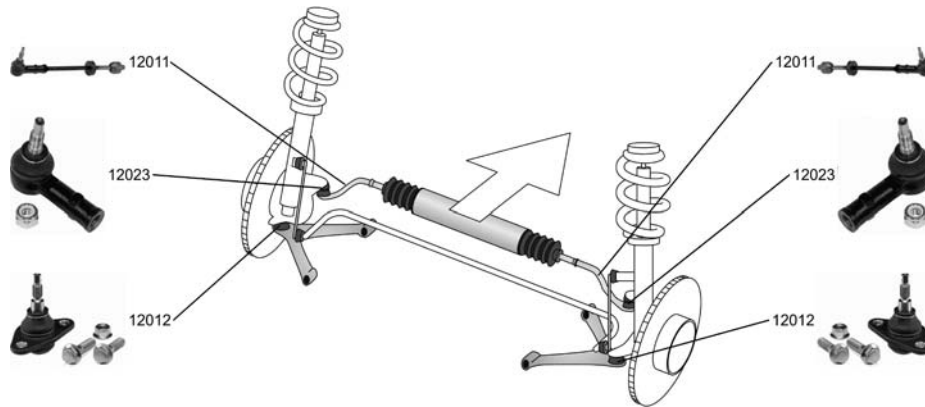

08.85 - 08.92

 Lagerung, Lenker / Mounting, wishbone ALL TYPES		20123 1 272 306 
Stabilisatorlager / Mounting, Stabilizer ALL TYPES		20120 1 229 608 
Lagerung, Panhardstab / Suspension, panhard rod ALL TYPES		20130 1 330 973 

760 (704, 764)

08.81 - 07.92





















Spurstange / Tie Rod, steering Achsausführung / Axle Version:ZF Rohr-Ø [mm] / Pipe Ø [mm]:12 Konusmaß [mm] / Cone Size [mm]:14 Gewindeart: mit Rechtsgewinde / Thread Type: with right-hand thread ALL TYPES ausser/except for : 2.3 01.88 - 07.92 2.4 01.82 - 07.92		12011 271 389 
Spurstangenkopf / Tie-rod End Konusmaß [mm] / Cone Size [mm]:14 Gewindeart: mit Rechtsgewinde / Thread Type: with right-hand thread Innengewinde [mm] / Inner Thread [mm]:M14x2 Gewindemaß / Thread Size:M14x2 für Lenkgetriebe-ID / For steering rack ID:ZF/CAM/TRW ALL TYPES ausser/except for : 2.3 01.88 - 07.92 2.4 01.82 - 07.92		12023 3 516 944 
Axialgelenk, Spurstange / Axial Rod, tie rod ALL TYPES ausser/except for : 2.3 01.88 - 07.92 2.4 01.82 - 07.92		12008 1 359 347 



VOLVO

760 (704, 764)

08.81 - 07.92

	Axialgelenk, Spurstange / Axial Rod, tie rod Achsausführung / Axle Version:CAM Gewindemaß / Thread Size:M14x2 Gewindeart: mit Rechtsgewinde / Thread Type: with right-hand thread		20133 9 140 504	
	2.8 (704) 05.86 - 08.91 2.8 (764) 08.86 - 07.90 2.4 Turbo Diesel (704), 80 kW 04.87 - 07.92 2.4 TD Interc. (704) 08.87 - 07.92	08.1988->		
	2.3 Turbo (704) 08.82 - 10.88 2.8 01.82 - 12.87 2.8 (704, 764) 08.81 - 07.88 2.4 Turbo Diesel (704), 82 kW 08.82 - 07.87			
	Trag-/Führungsgelenk / Support-/ Steering Link mit Befestigungsmaterial / with fastening material		12012 270 477	
	ALL TYPES ausser/except for : 2.3 01.88 - 07.92 2.4 01.82 - 07.92			
	Lagerung, Lenker / Mounting, wishbone		12037 1 359 599	
	ALL TYPES ausser/except for : 2.3 01.88 - 07.92 2.4 01.82 - 07.92			
	Achsstrebenlager / Mounting, axle strut		20128 1 329 655	
	2.3 Turbo (704) 08.82 - 10.88 2.8 (764) 08.86 - 07.90 2.8 (704, 764) 08.81 - 07.88 2.4 Turbo Diesel (704), 80 kW 04.87 - 07.92 2.4 TD Interc. (704) 08.87 - 07.92			
	Faltenbalgsatz, Lenkung / Bellow Kit, steering system		30185 1 272 925	
	ALL TYPES			
	Faltenbalgsatz, Lenkung / Bellow Kit, steering system		30186 1 272 924	
	ALL TYPES			
	Stabilisatorlager / Mounting, Stabilizer		20120 1 229 608	
	ALL TYPES ausser/except for : 2.3 01.88 - 07.92 2.4 01.82 - 07.92			
	Lagerung, Panhardstab / Suspension, panhard rod		20130 1 330 973	
	ALL TYPES ausser/except for : 2.3 01.88 - 07.92 2.4 01.82 - 07.92			











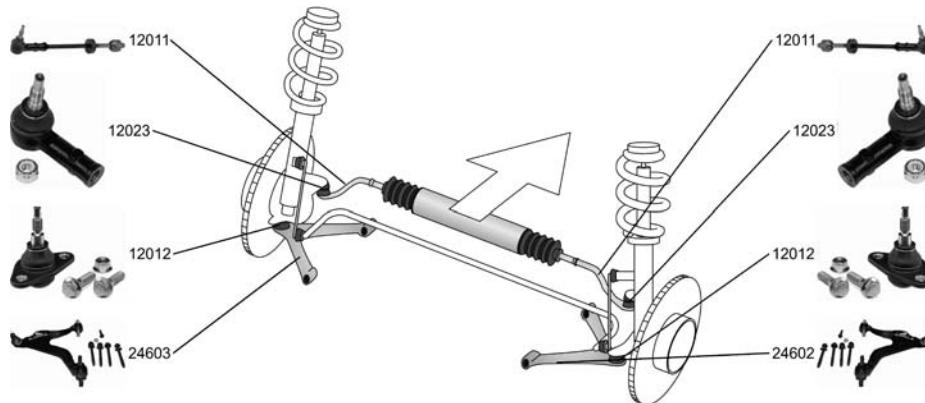





OE

VOLVO

760 Kombi/Estate/Break (704, 765)

01.82 - 07.92











<p>Spurstange / Tie Rod, steering Achsausführung / Axle Version:ZF Rohr-Ø [mm] / Pipe Ø [mm]:12 Konusmaß [mm] / Cone Size [mm]:14 Gewindeart: mit Rechtsgewinde / Thread Type: with right-hand thread</p>		<p>12011 271 389</p> 
<p>2.8 (765) 05.86 - 08.91</p>		
<p>2.4 TD Interc. (765) 08.87 - 07.92</p>		
<p>Spurstangenkopf / Tie-rod End Konusmaß [mm] / Cone Size [mm]:14 Gewindeart: mit Rechtsgewinde / Thread Type: with right-hand thread Innengewinde [mm] / Inner Thread [mm]:M14x2 Gewindemaß / Thread Size:M14x2 für Lenkgetriebe-ID / For steering rack ID:ZF/CAM/TRW</p>		<p>12023 3 516 944</p> 
<p>2.8 (765) 05.86 - 08.91</p>		
<p>2.4 TD Interc. (765) 08.87 - 07.92</p>		
<p>Axialgelenk, Spurstange / Axial Rod, tie rod</p>		<p>12008 1 359 347</p> 
<p>2.8 (765) 05.86 - 08.91</p>		
<p>2.4 TD Interc. (765) 08.87 - 07.92</p>		
<p>Axialgelenk, Spurstange / Axial Rod, tie rod Achsausführung / Axle Version:CAM Gewindemaß / Thread Size:M14x2 Gewindeart: mit Rechtsgewinde / Thread Type: with right-hand thread</p>		<p>20133 9 140 504</p> 
<p>2.8 (765), 105 kW 05.86 - 08.91</p>	<p>08.1988-></p>	
<p>2.4 TD Interc. (765) 08.87 - 07.92</p>		
<p>2.8 (765), 95 kW 05.86 - 12.87</p>		
<p>2.8 (765), 115 kW 08.86 - 08.90</p>		
<p>Lenker, Radaufhängung / Track Control Arm mit Gummilager / with rubber mounting</p>		<p>24602 8 628 498</p> 
<p>2.8 (765), 95 kW 05.86 - 12.87</p>		
<p>Lenker, Radaufhängung / Track Control Arm mit Gummilager / with rubber mounting</p>		<p>24603 8 628 497</p> 
<p>2.8 (765), 95 kW 05.86 - 12.87</p>		
<p>Trag-/Führungsgelenk / Support-/ Steering Link mit Befestigungsmaterial / with fastening material</p>		<p>12012 270 477</p> 
<p>2.8 (765) 05.86 - 08.91</p>		
<p>2.4 TD Interc. (765) 08.87 - 07.92</p>		



VOLVO





760 Kombi/Estate/Break (704, 765)

01.82 - 07.92

	Lagerung, Lenker / Mounting, wishbone	▼↔	12037	1 359 599
	2.8 (765) 2.4 TD Interc. (765)	05.86 - 08.91 08.87 - 07.92		
	Achsstrebenlager / Mounting, axle strut	↔↓	20128	1 329 655
	2.8 (765), 105 kW 2.8 (765), 115 kW 2.4 TD Interc. (765)	05.86 - 08.91 08.86 - 08.90 08.87 - 07.92		
	Faltenbalgsatz, Lenkung / Bellow Kit, steering system	↻	30185	1 272 925
	ALL TYPES			
	Faltenbalgsatz, Lenkung / Bellow Kit, steering system	↔	30186	1 272 924
	ALL TYPES			
	Stabilisatorlager / Mounting, Stabilizer	↑	20120	1 229 608
	2.8 (765) 2.4 TD Interc. (765)	05.86 - 08.91 08.87 - 07.92		
	Lagerung, Panhardstab / Suspension, panhard rod	↔	20130	1 330 973
	2.8 (765) 2.4 TD Interc. (765)	05.86 - 08.91 08.87 - 07.92		

780

08.86 - 07.90

	Spurstangenkopf / Tie-rod End	↻↔	12023	3 516 944
	Konusmaß [mm] / Cone Size [mm]:14 Gewindeart: mit Rechtsgewinde / Thread Type: with right-hand thread Innengewinde [mm] / Inner Thread [mm]:M14x2 Gewindemaß / Thread Size:M14x2 für Lenkgetriebe-ID / For steering rack ID:ZF/CAM/TRW	08.86 - 07.90		
	Trag-/Führungsgelenk / Support-/ Steering Link mit Befestigungsmaterial / with fastening material	▼↔	12012	270 477
	2.9	08.86 - 07.90		
	Faltenbalgsatz, Lenkung / Bellow Kit, steering system	↻	30185	1 272 925
	2.9	08.86 - 07.90		
	Faltenbalgsatz, Lenkung / Bellow Kit, steering system	↔	30186	1 272 924
	2.9	08.86 - 07.90		











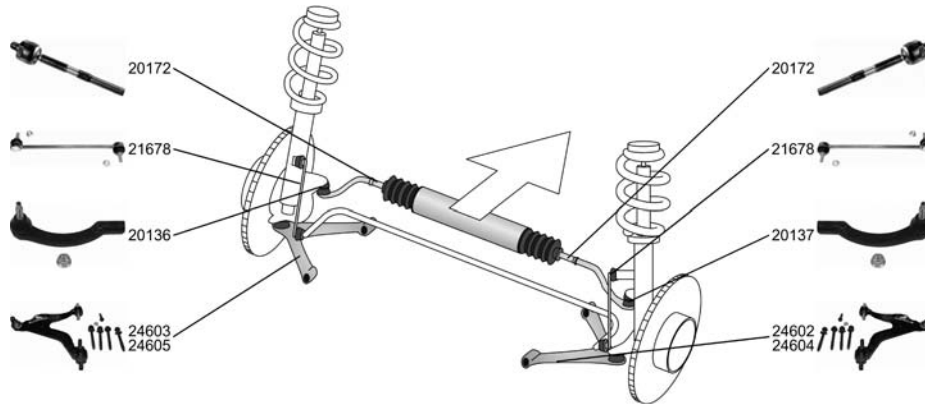









OE

VOLVO

850 (LS)

06.91 - 12.96









Spurstangenkopf / Tie-rod End mit Zubehör / With accessories ALL TYPES ausser/except for : 2.3 20V 01.94 - 12.97		20136 271 598 
Spurstangenkopf / Tie-rod End mit Zubehör / With accessories ALL TYPES ausser/except for : 2.3 20V 01.94 - 12.97		20137 271 599 
Axialgelenk, Spurstange / Axial Rod, tie rod Achsausführung / Axle Version:TRW Gewindemaß / Thread Size:M14x2 Gewindeart: mit Rechtsgewinde / Thread Type: with right-hand thread ALL TYPES ausser/except for : 2.3 20V 01.94 - 12.97		20172 3 546 266 
Lenker, Radaufhängung / Track Control Arm mit Gummilager / with rubber mounting 2.5 TDI 08.95 - 12.96		24602 8 628 498 
Lenker, Radaufhängung / Track Control Arm mit Gummilager / with rubber mounting 2.5 TDI 08.95 - 12.96		24603 8 628 497 
Lenker, Radaufhängung / Track Control Arm mit Gummilager / with rubber mounting ALL TYPES ausser/except for : 2.3 20V 01.94 - 12.97 2.5 TDI 08.95 - 12.96		24604 8 628 496 
Lenker, Radaufhängung / Track Control Arm mit Gummilager / with rubber mounting ALL TYPES ausser/except for : 2.3 20V 01.94 - 12.97 2.5 TDI 08.95 - 12.96		24605 8 628 495 
Trag-/Führungsgelenk / Support-/ Steering Link mit Zubehör / With accessories ALL TYPES ausser/except for : 2.3 20V 01.94 - 12.97		12031 271 591 
Lagerung, Lenker / Mounting, wishbone 2.0, 93 kW 08.94 - 12.96		112/A32 22652 271 631 



VOLVO

850 (LS)





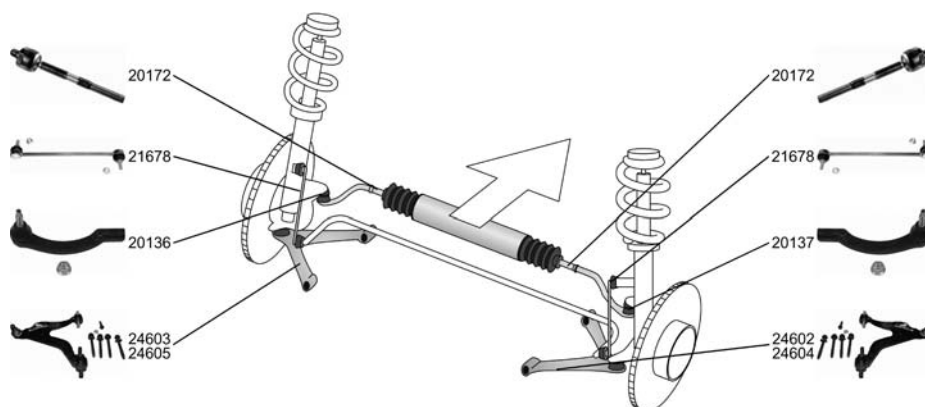

06.91 - 12.96

 Stange/Strebe, Stabilisator / Rod/Strut, stabiliser Pendelstange / Suspension Rod ALL TYPES ausser/except for : 2.3 20V		21678 30 714 686 
01.94 - 12.97		
 Achskörperlager / Mounting, axle body ALL TYPES ausser/except for : 2.3 20V		26815 3 516 122 
01.94 - 12.97		

850 Kombi/Estate/Break (LW)

04.92 - 12.96



Spurstangenkopf / Tie-rod End mit Zubehör / With accessories ALL TYPES ausser/except for : 2.3 20V		20136 271 598 
01.94 - 12.97		
Spurstangenkopf / Tie-rod End mit Zubehör / With accessories ALL TYPES ausser/except for : 2.3 20V		20137 271 599 
01.94 - 12.97		
Axialgelenk, Spurstange / Axial Rod, tie rod Achsausführung / Axle Version: TRW Gewindemaß / Thread Size: M14x2 Gewindeart: mit Rechtsgewinde / Thread Type: with right-hand thread ALL TYPES ausser/except for : 2.3 20V	 	20172 3 546 266 
01.94 - 12.97		
Lenker, Radaufhängung / Track Control Arm mit Gummilager / with rubber mounting 2.5 TDI	 	24602 8 628 498 
08.95 - 12.96		
Lenker, Radaufhängung / Track Control Arm mit Gummilager / with rubber mounting 2.5 TDI	 	24603 8 628 497 
08.95 - 12.96		
Lenker, Radaufhängung / Track Control Arm mit Gummilager / with rubber mounting ALL TYPES ausser/except for : 2.3 20V 2.5 TDI	 	24604 8 628 496 
01.94 - 12.97 08.95 - 12.96		



OE

VOLVO

850 Kombi/Estate/Break (LW)

04.92 - 12.96

<p> Lenker, Radaufhängung / Track Control Arm mit Gummilager / with rubber mounting</p> <p>ALL TYPES ausser/except for : 2.3 20V 01.94 - 12.97 2.5 TDI 08.95 - 12.96</p>	<p></p>	<p>24605 8 628 495</p> 
<p>Trag-/Führungsgelenk / Support-/ Steering Link mit Zubehör / With accessories</p> <p>2.0 02.93 - 12.96 2.0 Turbo 02.93 - 12.96 2.3 T5-R 08.95 - 12.96 2.5 08.92 - 12.96 2.5 AWD 04.96 - 12.96 2.5 TDI 08.95 - 12.96 2.3 T5 02.93 - 12.96</p>	<p> ->Chass. CH-37527</p>	<p>12031 271 591</p> 
<p>Lagerung, Lenker / Mounting, wishbone</p> <p>ALL TYPES ausser/except for : 2.3 20V 01.94 - 12.97</p>	<p> I12/A32</p>	<p>22652 271 631</p> 
<p>Stange/Strebe, Stabilisator / Rod/Strut, stabiliser Pendelstange / Suspension Rod</p> <p>ALL TYPES ausser/except for : 2.3 20V 01.94 - 12.97</p>	<p></p>	<p>21678 30 714 686</p> 
<p> Achskörperlager / Mounting, axle body</p> <p>ALL TYPES ausser/except for : 2.3 20V 01.94 - 12.97</p>	<p></p>	<p>26815 3 516 122</p> 

940 (944)

08.90 - 12.94

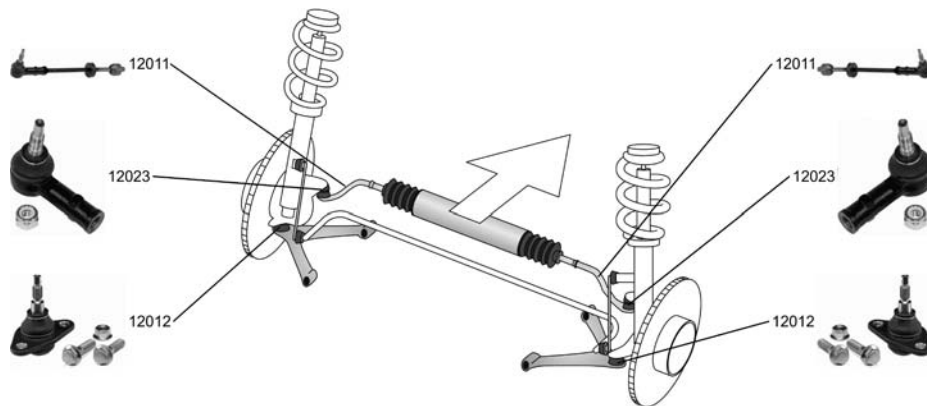

<p>Spurstange / Tie Rod, steering Achsausführung / Axle Version:ZF Rohr-Ø [mm] / Pipe Ø [mm]:12 Konusmaß [mm] / Cone Size [mm]:14 Gewindeart: mit Rechtsgewinde / Thread Type: with right-hand thread</p> <p>ALL TYPES ausser/except for : 2.0 i Turbo 01.90 - 12.94 2.0 i 16V 2.0 i 16V Turbo</p>	<p></p>	<p>12011 271 389</p> 
<p>Spurstangenkopf / Tie-rod End Konusmaß [mm] / Cone Size [mm]:14 Gewindeart: mit Rechtsgewinde / Thread Type: with right-hand thread Innengewinde [mm] / Inner Thread [mm]:M14x2 Gewindemaß / Thread Size:M14x2 für Lenkgetriebe-ID / For steering rack ID:ZF/CAM/TRW</p> <p>ALL TYPES ausser/except for : 2.0 i Turbo 01.90 - 12.94 2.0 i 16V 2.0 i 16V Turbo</p>	<p></p>	<p>12023 3 516 944</p> 



VOLVO

940 (944)

08.90 - 12.94

	Axialgelenk, Spurstange / Axial Rod, tie rod Achsausführung / Axle Version:CAM Gewindemaß / Thread Size:M14x2 Gewindeart: mit Rechtsgewinde / Thread Type: with right-hand thread		20133 9 140 504	
	2.0 01.92 - 07.94 2.3 08.90 - 12.94 2.3 Turbo 08.90 - 07.94 2.4 D 08.90 - 12.94 2.4 Turbo Diesel 08.90 - 12.94 2.4 TD Intercooler 08.90 - 12.94			
	Trag-/Führungsgelenk / Support-/ Steering Link mit Befestigungsmaterial / with fastening material		12012 270 477	
	ALL TYPES ausser/except for : 2.0 i Turbo 2.0 i 16V 01.90 - 12.94 2.0 i 16V Turbo			
	Lagerung, Lenker / Mounting, wishbone		12037 1 359 599	
	ALL TYPES ausser/except for : 2.0 i Turbo 2.0 i 16V 01.90 - 12.94 2.0 i 16V Turbo			
	Achsstrebenlager / Mounting, axle strut		20128 1 329 655	
	ALL TYPES ausser/except for : 2.0 i Turbo 2.0 i 16V 01.90 - 12.94 2.0 i 16V Turbo			
	Lagerung, Lenker / Mounting, wishbone ALL TYPES ausser/except for : 2.0 i Turbo 2.0 i 16V 01.90 - 12.94 2.0 i 16V Turbo		20123 1 272 306	
	Stabilisatorlager / Mounting, Stabilizer		20120 1 229 608	
	ALL TYPES ausser/except for : 2.0 i Turbo 2.0 i 16V 01.90 - 12.94 2.0 i 16V Turbo			
	Lagerung, Panhardstab / Suspension, panhard rod		20130 1 330 973	
	ALL TYPES ausser/except for : 2.0 i Turbo 2.0 i 16V 01.90 - 12.94 2.0 i 16V Turbo			











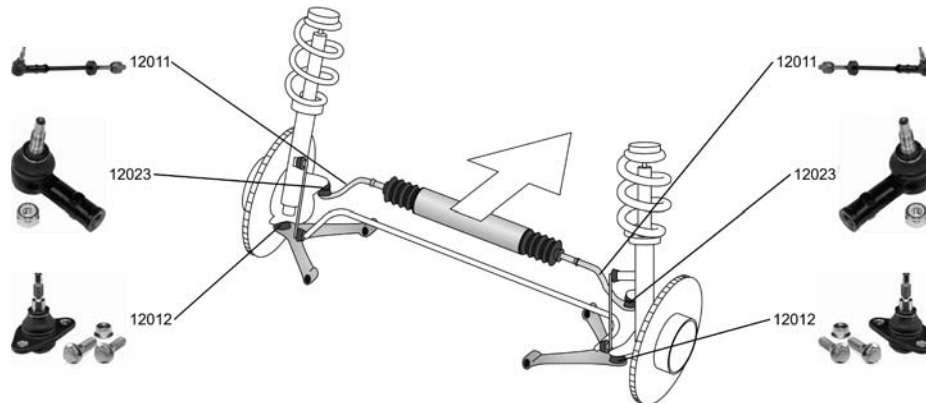





OE

VOLVO

940 Kombi/Estate/Break (945)

08.90 - 07.95



<p>Spurstange / Tie Rod, steering Achsausführung / Axle Version:ZF Rohr-Ø [mm] / Pipe Ø [mm]:12 Konusmaß [mm] / Cone Size [mm]:14 Gewindeart: mit Rechtsgewinde / Thread Type: with right-hand thread</p>		<p>12011 271 389</p> 
<p>ALL TYPES ausser/except for : 2.0 i 16V Turbo 2.0 i 16V</p>	<p>01.90 - 12.94</p>	
<p>Spurstangenkopf / Tie-rod End Konusmaß [mm] / Cone Size [mm]:14 Gewindeart: mit Rechtsgewinde / Thread Type: with right-hand thread Innengewinde [mm] / Inner Thread [mm]:M14x2 Gewindemaß / Thread Size:M14x2 für Lenkgetriebe-ID / For steering rack ID:ZF/CAM/TRW</p>		<p>12023 3 516 944</p> 
<p>ALL TYPES ausser/except for : 2.0 i 16V Turbo 2.0 i 16V</p>	<p>01.90 - 12.94</p>	
<p>Axialgelenk, Spurstange / Axial Rod, tie rod Achsausführung / Axle Version:CAM Gewindemaß / Thread Size:M14x2 Gewindeart: mit Rechtsgewinde / Thread Type: with right-hand thread</p>		<p>20133 9 140 504</p> 
<p>2.0 01.92 - 07.94 2.0 Turbo 01.91 - 07.95 2.3 08.90 - 12.94 2.3 Turbo 08.90 - 07.94 2.4 Turbo Diesel 08.90 - 07.94</p>		
<p>Trag-/Führungsgelenk / Support-/ Steering Link mit Befestigungsmaterial / with fastening material</p>		<p>12012 270 477</p> 
<p>ALL TYPES ausser/except for : 2.0 i 16V Turbo 2.0 i 16V</p>	<p>01.90 - 12.94</p>	
<p>Lagerung, Lenker / Mounting, wishbone</p>		<p>12037 1 359 599</p> 
<p>ALL TYPES ausser/except for : 2.0 i 16V Turbo 2.0 i 16V</p>	<p>01.90 - 12.94</p>	
<p>Achsstrebenlager / Mounting, axle strut</p>		<p>20128 1 329 655</p> 
<p>ALL TYPES ausser/except for : 2.0 i 16V Turbo 2.0 i 16V</p>	<p>01.90 - 12.94</p>	
<p>Lagerung, Lenker / Mounting, wishbone</p>		<p>20123 1 272 306</p> 
<p>ALL TYPES ausser/except for : 2.0 i 16V Turbo 2.0 i 16V</p>	<p>01.90 - 12.94</p>	





VOLVO

940 Kombi/Estate/Break (945)





08.90 - 07.95

<p> Stabilisatorlager / Mounting, Stabilizer ALL TYPES ausser/except for : 2.0 i 16V Turbo 2.0 i 16V 01.90 - 12.94</p>	<p>↑</p>	<p>20120 1 229 608</p> 
<p>Lagerung, Panhardstab / Suspension, panhard rod ALL TYPES ausser/except for : 2.0 i 16V Turbo 2.0 i 16V 01.90 - 12.94</p>	<p>↔</p>	<p>20130 1 330 973</p> 

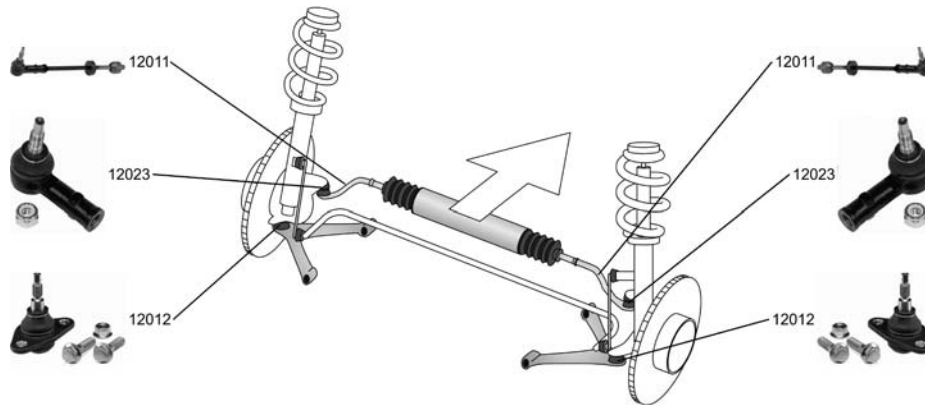
940 II (944)

08.94 - 10.98













<p>Spurstange / Tie Rod, steering Achsausführung / Axle Version:ZF Rohr-Ø [mm] / Pipe Ø [mm]:12 Konusmaß [mm] / Cone Size [mm]:14 Gewindeart: mit Rechtsgewinde / Thread Type: with right-hand thread ALL TYPES</p>	<p>↔ ♂</p>	<p>12011 271 389</p> 
<p>Spurstangenkopf / Tie-rod End Konusmaß [mm] / Cone Size [mm]:14 Gewindeart: mit Rechtsgewinde / Thread Type: with right-hand thread Innengewinde [mm] / Inner Thread [mm]:M14x2 Gewindemaß / Thread Size:M14x2 für Lenkgetriebe-ID / For steering rack ID:ZF/CAM/TRW ALL TYPES</p>	<p>↔ ♂</p>	<p>12023 3 516 944</p> 
<p>Axialgelenk, Spurstange / Axial Rod, tie rod Achsausführung / Axle Version:CAM Gewindemaß / Thread Size:M14x2 Gewindeart: mit Rechtsgewinde / Thread Type: with right-hand thread ALL TYPES ausser/except for : 2.0 Turbo 04.96 - 10.98</p>	<p>≡</p>	<p>20133 9 140 504</p> 
<p>Trag-/Führungsgelenk / Support-/ Steering Link mit Befestigungsmaterial / with fastening material ALL TYPES</p>	<p>▽ ↔</p>	<p>12012 270 477</p> 
<p>Lagerung, Lenker / Mounting, wishbone ALL TYPES</p>	<p>▽ ↔</p>	<p>12037 1 359 599</p> 



OE





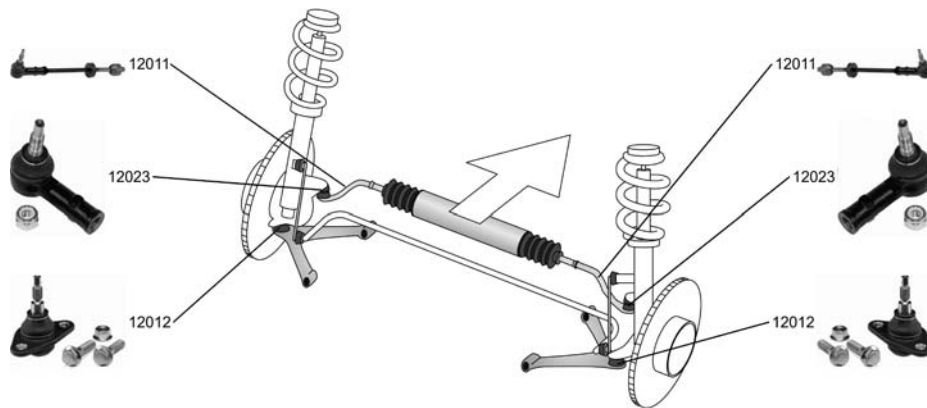

VOLVO

940 II (944) 08.94 - 10.98

	Achsstrebenlager / Mounting, axle strut ALL TYPES		20128	1 329 655	
	Lagerung, Lenker / Mounting, wishbone ALL TYPES		20123	1 272 306	
	Stabilisatorlager / Mounting, Stabilizer ALL TYPES		20120	1 229 608	
	Lagerung, Panhardstab / Suspension, panhard rod ALL TYPES		20130	1 330 973	

940 Kombi/II Estate/Break (945) 08.94 - 10.98









Spurstange / Tie Rod, steering		12011	271 389	
Achsausführung / Axle Version:ZF Rohr-Ø [mm] / Pipe Ø [mm]:12 Konusmaß [mm] / Cone Size [mm]:14 Gewindeart: mit Rechtsgewinde / Thread Type: with right-hand thread ALL TYPES				
Spurstangenkopf / Tie-rod End		12023	3 516 944	
Konusmaß [mm] / Cone Size [mm]:14 Gewindeart: mit Rechtsgewinde / Thread Type: with right-hand thread Innengewinde [mm] / Inner Thread [mm]:M14x2 Gewindemaß / Thread Size:M14x2 für Lenkgetriebe-ID / For steering rack ID:ZF/CAM/TRW ALL TYPES				
Axialgelenk, Spurstange / Axial Rod, tie rod		20133	9 140 504	
Achsausführung / Axle Version:CAM Gewindemaß / Thread Size:M14x2 Gewindeart: mit Rechtsgewinde / Thread Type: with right-hand thread ALL TYPES ausser/except for : 2.0 Turbo			04.96 - 10.98	



VOLVO

940 Kombi/II Estate/Break (945)

08.94 - 10.98

	Trag-/Führungsgelenk / Support-/ Steering Link mit Befestigungsmaterial / with fastening material ALL TYPES	▼↔	12012	270 477	
	Lagerung, Lenker / Mounting, wishbone ALL TYPES	▼↔	12037	1 359 599	
	Achsstrebenlager / Mounting, axle strut ALL TYPES	↔↓	20128	1 329 655	
	Lagerung, Lenker / Mounting, wishbone ALL TYPES	▼↔↓	20123	1 272 306	
	Stabilisatorlager / Mounting, Stabilizer ALL TYPES	↑	20120	1 229 608	
	Lagerung, Panhardstab / Suspension, panhard rod ALL TYPES	↔	20130	1 330 973	

960 (964)

08.90 - 07.94

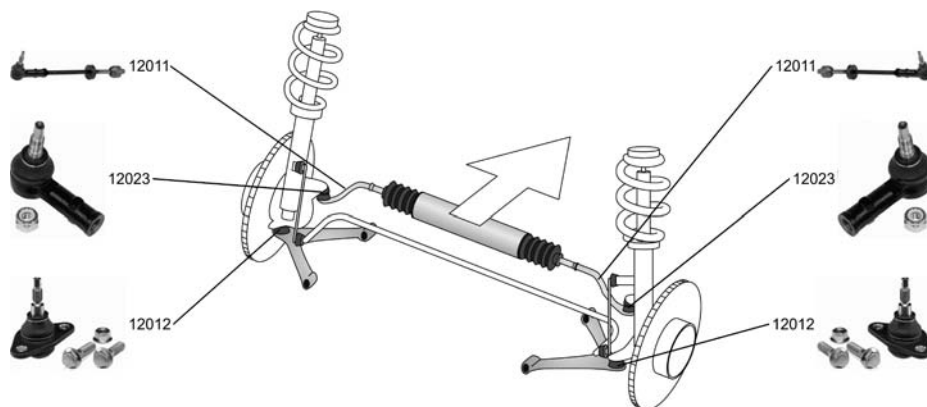

Spurstange / Tie Rod, steering Achsausführung / Axle Version:ZF Rohr-Ø [mm] / Pipe Ø [mm]:12 Konusmaß [mm] / Cone Size [mm]:14 Gewindeart: mit Rechtsgewinde / Thread Type: with right-hand thread ALL TYPES	↔↗	12011	271 389	
--	----	--------------	---------	---

















OE

VOLVO

960 (964)

08.90 - 07.94

	<p>Spurstangenkopf / Tie-rod End Konusmaß [mm] / Cone Size [mm]:14 Gewindeart: mit Rechtsgewinde / Thread Type: with right-hand thread Innengewinde [mm] / Inner Thread [mm]:M14x2 Gewindemaß / Thread Size:M14x2 für Lenkgetriebe-ID / For steering rack ID:ZF/CAM/TRW</p>		<p>12023 3 516 944</p>	
ALL TYPES				
	<p>Axialgelenk, Spurstange / Axial Rod, tie rod Achsausführung / Axle Version:CAM Gewindemaß / Thread Size:M14x2 Gewindeart: mit Rechtsgewinde / Thread Type: with right-hand thread</p>		<p>20133 9 140 504</p>	
ALL TYPES				
	<p>Trag-/Führungsgelenk / Support-/ Steering Link mit Befestigungsmaterial / with fastening material</p>		<p>12012 270 477</p>	
ALL TYPES				
	<p>Lagerung, Lenker / Mounting, wishbone</p>		<p>12037 1 359 599</p>	
ALL TYPES				
	<p>Lagerung, Lenker / Mounting, wishbone</p>		<p>20123 1 272 306</p>	
ALL TYPES				
	<p>Stabilisatorlager / Mounting, Stabilizer</p>		<p>20120 1 229 608</p>	
ALL TYPES				
	<p>Lagerung, Panhardstab / Suspension, panhard rod</p>		<p>20130 1 330 973</p>	
ALL TYPES				









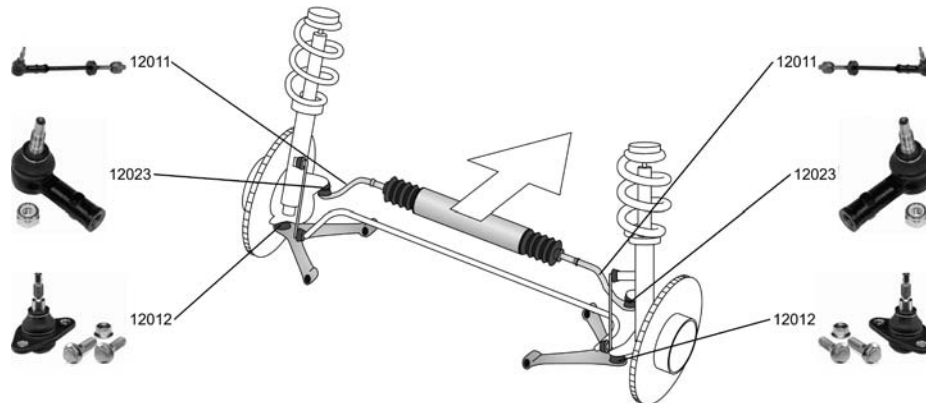









VOLVO

960 Kombi/Estate/Break (965)

08.90 - 07.94



<p>Spurstange / Tie Rod, steering Achsausführung / Axle Version:ZF Rohr-Ø [mm] / Pipe Ø [mm]:12 Konusmaß [mm] / Cone Size [mm]:14 Gewindeart: mit Rechtsgewinde / Thread Type: with right-hand thread ALL TYPES</p>		<p>12011 271 389</p> 
<p>Spurstangenkopf / Tie-rod End Konusmaß [mm] / Cone Size [mm]:14 Gewindeart: mit Rechtsgewinde / Thread Type: with right-hand thread Innengewinde [mm] / Inner Thread [mm]:M14x2 Gewindemaß / Thread Size:M14x2 für Lenkgetriebe-ID / For steering rack ID:ZF/CAM/TRW ALL TYPES</p>		<p>12023 3 516 944</p> 
<p>Axialgelenk, Spurstange / Axial Rod, tie rod Achsausführung / Axle Version:CAM Gewindemaß / Thread Size:M14x2 Gewindeart: mit Rechtsgewinde / Thread Type: with right-hand thread ALL TYPES</p>		<p>20133 9 140 504</p> 
<p>Trag-/Führungsgelenk / Support-/ Steering Link mit Befestigungsmaterial / with fastening material ALL TYPES</p>		<p>12012 270 477</p> 
<p>Lagerung, Lenker / Mounting, wishbone ALL TYPES</p>		<p>12037 1 359 599</p> 
<p> Lagerung, Lenker / Mounting, wishbone ALL TYPES</p>		<p>20123 1 272 306</p> 
<p>Stabilisatorlager / Mounting, Stabilizer ALL TYPES</p>		<p>20120 1 229 608</p> 
<p>Lagerung, Panhardstab / Suspension, panhard rod ALL TYPES</p>		<p>20130 1 330 973</p> 



OE

VOLVO

960 II (964)

07.94 - 12.96

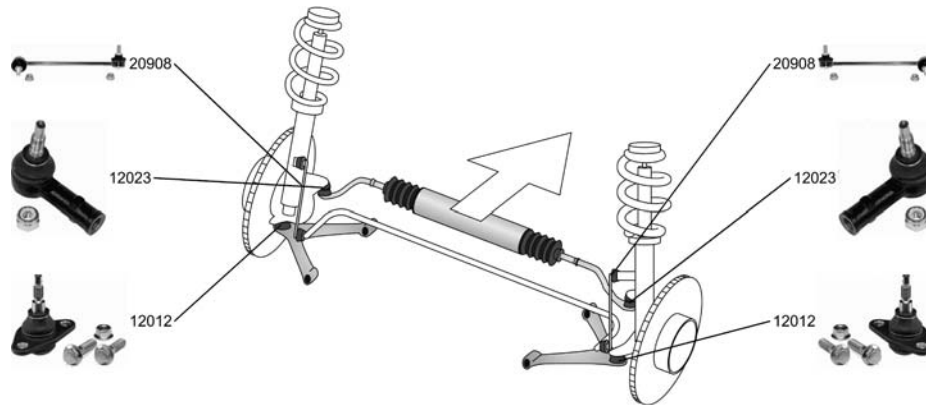

<p>Spurstangenkopf / Tie-rod End Konusmaß [mm] / Cone Size [mm]:14 Gewindeart: mit Rechtsgewinde / Thread Type: with right-hand thread Innengewinde [mm] / Inner Thread [mm]:M14x2 Gewindemaß / Thread Size:M14x2 für Lenkgetriebe-ID / For steering rack ID:ZF/CAM/TRW ALL TYPES</p>		<p>12023 3 516 944</p> 
<p>Axialgelenk, Spurstange / Axial Rod, tie rod Achsausführung / Axle Version:CAM Gewindemaß / Thread Size:M14x2 Gewindeart: mit Rechtsgewinde / Thread Type: with right-hand thread ALL TYPES</p>		<p>20133 9 140 504</p> 
<p>Trag-/Führungsgelenk / Support-/ Steering Link mit Befestigungsmaterial / with fastening material ALL TYPES</p>		<p>12012 270 477</p> 
<p>Lagerung, Lenker / Mounting, wishbone ALL TYPES</p>		<p>25996 6 819 537</p> 
<p>Lagerung, Lenker / Mounting, wishbone ALL TYPES</p>		<p>29543 9 191 537</p> 
<p>Stange/Strebe, Stabilisator / Rod/Strut, stabiliser Pendelstange / Suspension Rod ALL TYPES</p>		<p>20908 272 991</p> 
<p> Lagerung, Lenker / Mounting, wishbone ALL TYPES</p>		<p>20123 1 272 306</p> 
<p>Stabilisatorlager / Mounting, Stabilizer ALL TYPES</p>		<p>20120 1 229 608</p> 



VOLVO

960 II (964)

07.94 - 12.96



Lagerung, Panhardstab / Suspension, panhard rod
ALL TYPES



20130

1 330 973



960 Kombi/II Estate/Break (965)

07.94 - 12.96

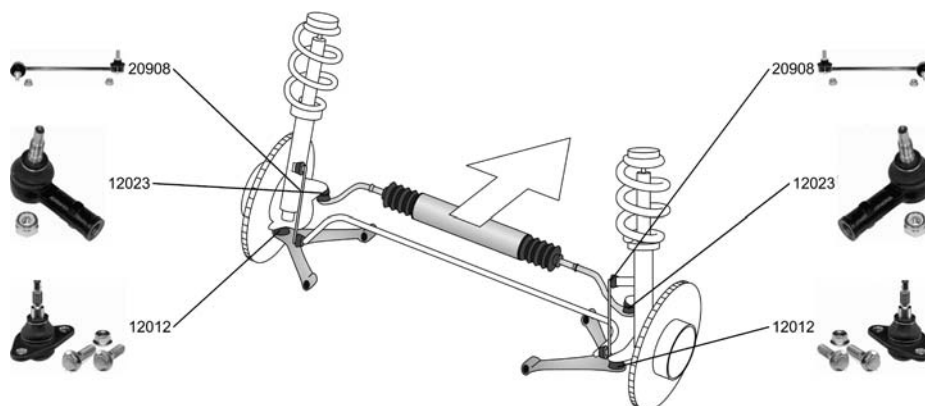

Spurstangenkopf / Tie-rod End

Konusmaß [mm] / Cone Size [mm]:14
Gewindeart: mit Rechtsgewinde / Thread Type: with right-hand thread
Innengewinde [mm] / Inner Thread [mm]:M14x2
Gewindemaß / Thread Size:M14x2
für Lenkgetriebe-ID / For steering rack ID:ZF/CAM/TRW



12023

3 516 944



ALL TYPES

Axialgelenk, Spurstange / Axial Rod, tie rod

Achsausführung / Axle Version:CAM
Gewindemaß / Thread Size:M14x2
Gewindeart: mit Rechtsgewinde / Thread Type: with right-hand thread



20133

9 140 504



ALL TYPES

Trag-/Führungsgelenk / Support-/ Steering Link
mit Befestigungsmaterial / with fastening material



12012

270 477



ALL TYPES

Lagerung, Lenker / Mounting, wishbone

2.5

08.94 - 12.96



25996

6 819 537



Lagerung, Lenker / Mounting, wishbone

2.5

08.94 - 12.96



29543

9 191 537



Stange/Strebe, Stabilisator / Rod/Strut, stabiliser
Pendelstange / Suspension Rod

ALL TYPES



20908

272 991



Lagerung, Lenker / Mounting, wishbone

ALL TYPES



20123

1 272 306









OE

VOLVO

960 Kombi/II Estate/Break (965)









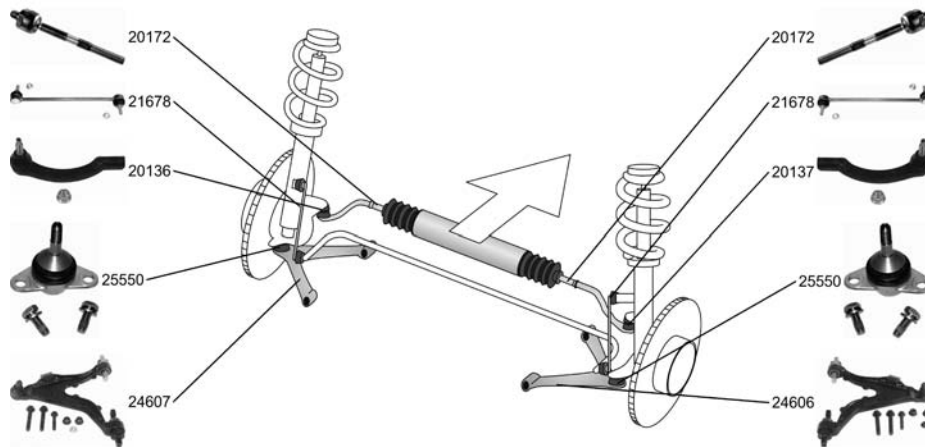



07.94 - 12.96

 Stabilisatorlager / Mounting, Stabilizer ALL TYPES		20120 1 229 608 
Lagerung, Panhardstab / Suspension, panhard rod ALL TYPES		20130 1 330 973 

C70 Coupe

03.97 - 09.02

















Spurstangenkopf / Tie-rod End mit Zubehör / With accessories ALL TYPES ausser/except for : 2.0 T, 120 kW 01.98 -		20136 271 598 
Spurstangenkopf / Tie-rod End mit Zubehör / With accessories ALL TYPES ausser/except for : 2.0 T, 120 kW 01.98 -		20137 271 599 
Axialgelenk, Spurstange / Axial Rod, tie rod Achsausführung / Axle Version:TRW Gewindemaß / Thread Size:M14x2 Gewindeart: mit Rechtsgewinde / Thread Type: with right-hand thread ALL TYPES ausser/except for : 2.0 T, 120 kW 01.98 -		20172 3 546 266 
Lenker, Radaufhängung / Track Control Arm mit Gummilager / with rubber mounting ALL TYPES ausser/except for : 2.0 T, 120 kW 01.98 -		24606 8 628 500 
Lenker, Radaufhängung / Track Control Arm mit Gummilager / with rubber mounting ALL TYPES ausser/except for : 2.0 T, 120 kW 01.98 -		24607 8 628 499 
Trag-/Führungsgelenk / Support-/ Steering Link mit Zubehör / With accessories Gewindemaß / Thread Size:M12x1,75 Konusmaß [mm] / Cone Size [mm]:12,5 ALL TYPES ausser/except for : 2.0 T, 120 kW 01.98 -		25550 274 548 



VOLVO

C70 Coupe





03.97 - 09.02

 Lagerung, Lenker / Mounting, wishbone ALL TYPES ausser/except for : 2.0 T, 120 kW		112/A32	22652	271 631
	01.98 -			
Stange/Strebe, Stabilisator / Rod/Strut, stabiliser Pendelstange / Suspension Rod ALL TYPES ausser/except for : 2.0 T, 120 kW			21678	30 714 686
	01.98 -			
Faltenbaldsatz, Lenkung / Bellow Kit, steering system ALL TYPES ausser/except for : 2.0 T, 120 kW		für / for: SMI	30233	9 191 409
	01.98 -			
Faltenbaldsatz, Lenkung / Bellow Kit, steering system ALL TYPES ausser/except for : 2.0 T, 120 kW		für / for: TRW	30242	271 601
	01.98 -			
 Lagerung, Lenker / Mounting, wishbone ALL TYPES ausser/except for : 2.0 T, 120 kW			27705	9 181 013
	01.98 -			
Lagerung, Lenker / Mounting, wishbone ALL TYPES ausser/except for : 2.0 T, 120 kW			27706	9 181 027
	01.98 -			
Achskörperlager / Mounting, axle body ALL TYPES ausser/except for : 2.0 T, 120 kW			26815	3 516 122
	01.98 -			

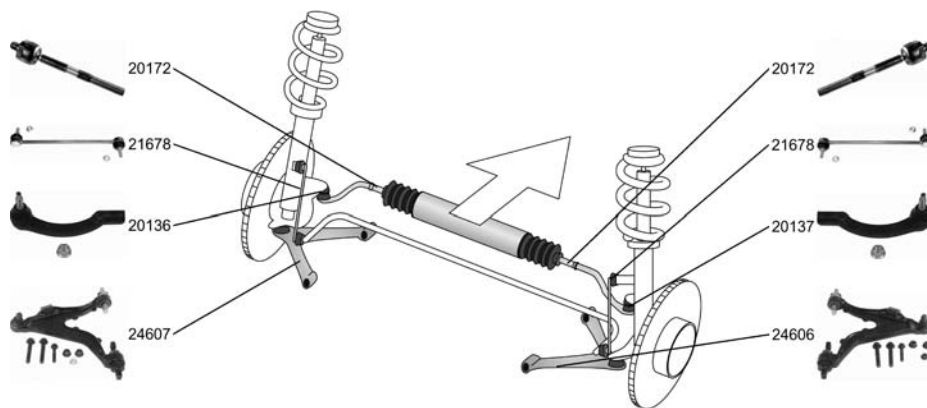
C70 Cabrio/Convertible

03.98 -



Spurstangenkopf / Tie-rod End mit Zubehör / With accessories ALL TYPES ausser/except for : 2.0 T, 120 kW			20136	271 598
	01.98 -			
Spurstangenkopf / Tie-rod End mit Zubehör / With accessories ALL TYPES ausser/except for : 2.0 T, 120 kW			20137	271 599
	01.98 -			























OE

VOLVO

C70 Cabrio/Convertible

03.98 -

	Axialgelenk, Spurstange / Axial Rod, tie rod Achsausführung / Axle Version:TRW Gewindemaß / Thread Size:M14x2 Gewindeart: mit Rechtsgewinde / Thread Type: with right-hand thread		20172	3 546 266	
	ALL TYPES ausser/except for : 2.0 T, 120 kW 01.98 -				
	Lenker, Radaufhängung / Track Control Arm mit Gummilager / with rubber mounting		24606	8 628 500	
	ALL TYPES ausser/except for : 2.0 T, 120 kW 01.98 -				
	Lenker, Radaufhängung / Track Control Arm mit Gummilager / with rubber mounting		24607	8 628 499	
	ALL TYPES ausser/except for : 2.0 T, 120 kW 01.98 -				
	Lagerung, Lenker / Mounting, wishbone		112/A32	22652	271 631
	ALL TYPES ausser/except for : 2.0 T, 120 kW 01.98 -				
	Stange/Strebe, Stabilisator / Rod/Strut, stabiliser Pendelstange / Suspension Rod			21678	30 714 686
	ALL TYPES ausser/except for : 2.0 T, 120 kW 01.98 -				
	Faltenbalgsatz, Lenkung / Bellow Kit, steering system			30233	9 191 409
	ALL TYPES ausser/except for : 2.0 T, 120 kW 01.98 -		für / for:SML		
	Faltenbalgsatz, Lenkung / Bellow Kit, steering system			30242	271 601
	ALL TYPES ausser/except for : 2.0 T, 120 kW 01.98 -		für / for:TRW		
	Lagerung, Lenker / Mounting, wishbone ALL TYPES ausser/except for : 2.0 T, 120 kW 01.98 -			27705	9 181 013
					
	Lagerung, Lenker / Mounting, wishbone ALL TYPES ausser/except for : 2.0 T, 120 kW 01.98 -			27706	9 181 027
					
	Achskörperlager / Mounting, axle body ALL TYPES ausser/except for : 2.0 T, 120 kW 01.98 -			26815	3 516 122
					



OE

VOLVO

S40 I (VS)

07.95 - 12.03





<p> Spurstangenkopf / Tie-rod End radseitig / Wheel Side Konusmaß [mm] / Cone Size [mm]:15,3 Aussengewinde [mm] / Outer Thread [mm]:M10x1,25 Innengewinde [mm] / Inner Thread [mm]:M14x1,5 mit Zubehör / With accessories</p>		<p>27613 274 226</p> 
<p>1.6, 80 kW 1.8, 90 kW 1.8 i, 92 kW 2.0, 100 kW</p>	<p>03.99 - 12.03 03.99 - 12.03 03.98 - 12.03 07.95 - 12.03</p>	<p>07.2000-></p>
<p>1.8 i, 90 kW 2.0 T, 120 kW 2.0 T, 121 kW 2.0 T4 1.9 DI, 75 kW 1.9 DI, 85 kW</p>	<p>06.01 - 12.03 06.01 - 12.03 07.00 - 06.01 07.00 - 12.03 07.00 - 12.03 07.00 - 12.03</p>	
<p>Axialgelenk, Spurstange / Axial Rod, tie rod</p>		<p>25487 3 345 797</p>
<p>1.6, 77 kW 1.8, 85 kW 1.9 T4 2.0, 103 kW 2.0 T, 118 kW 2.0 T, 121 kW 1.9 TD 1.9 DI, 70 kW</p>	<p>09.95 - 08.99 07.95 - 08.99 05.97 - 07.00 07.95 - 08.99 10.97 - 07.00 07.00 - 06.01 07.95 - 08.99 03.99 - 07.00</p>	
<p>1.6, 80 kW 1.8, 90 kW 1.8 i, 92 kW 2.0, 100 kW 2.0 T, 120 kW 2.0 T4 1.9 DI, 75 kW 1.9 DI, 85 kW</p>	<p>03.99 - 12.03 03.99 - 12.03 03.98 - 12.03 07.95 - 12.03 06.01 - 12.03 07.00 - 12.03 07.00 - 12.03 07.00 - 12.03</p>	<p>->12.2000</p>
<p>Lagerung, Lenker / Mounting, wishbone</p>		<p>25997 30 818 467</p>
<p>1.6, 77 kW 1.8, 85 kW 1.8 i, 90 kW 2.0, 103 kW 2.0 T, 120 kW 1.9 TD</p>	<p>09.95 - 08.99 07.95 - 08.99 06.01 - 12.03 07.95 - 08.99 06.01 - 12.03 07.95 - 08.99</p>	
<p>1.6, 80 kW 1.8, 90 kW 1.8 i, 92 kW 2.0, 100 kW</p>	<p>03.99 - 12.03 03.99 - 12.03 03.98 - 12.03 07.95 - 12.03</p>	<p>01.2001 - 12.1999</p>
<p>1.9 T4 2.0 T, 118 kW 1.9 DI, 70 kW</p>	<p>05.97 - 07.00 10.97 - 07.00 03.99 - 07.00</p>	<p>->12.1999</p>
<p>2.0 T, 121 kW 2.0 T4 1.9 DI, 75 kW 1.9 DI, 85 kW</p>	<p>07.00 - 06.01 07.00 - 12.03 07.00 - 12.03 07.00 - 12.03</p>	<p>01.2001-></p>
<p>Lagerung, Lenker / Mounting, wishbone</p>		<p>26588 30 887 024</p>
<p>1.6, 80 kW 1.8, 90 kW 1.8 i, 92 kW 2.0, 100 kW</p>	<p>03.99 - 12.03 03.99 - 12.03 03.98 - 12.03 07.95 - 12.03</p>	<p>01.2000 - 12.2000</p>
<p>1.9 T4 2.0 T, 118 kW 1.9 DI, 70 kW</p>	<p>05.97 - 07.00 10.97 - 07.00 03.99 - 07.00</p>	<p>01.2000-></p>
<p>2.0 T, 121 kW 2.0 T4 1.9 DI, 75 kW 1.9 DI, 85 kW</p>	<p>07.00 - 06.01 07.00 - 12.03 07.00 - 12.03 07.00 - 12.03</p>	<p>->12.2000</p>



VOLVO

S40 I (VS)





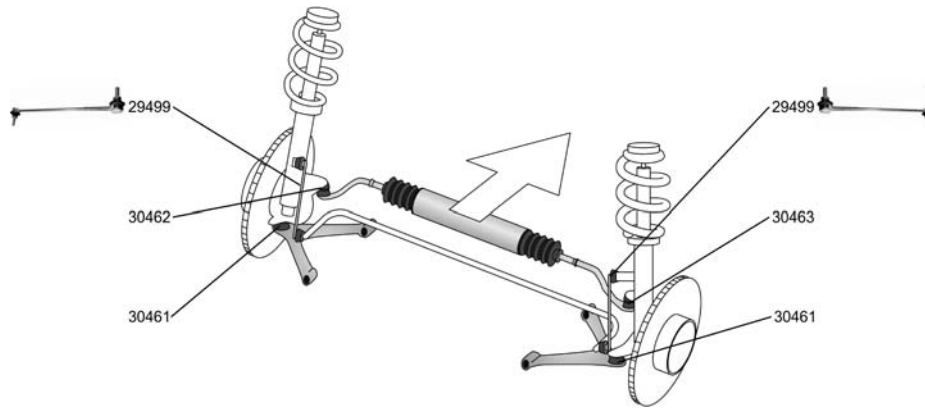

07.95 - 12.03

 Stange/Strebe, Stabilisator / Rod/Strut, stabiliser Pendelstange / Suspension Rod Gewindemaß / Thread Size:M10x1,25		29640 30 884 358
1.6, 77 kW 09.95 - 08.99 1.8, 85 kW 07.95 - 08.99 1.9 T4 05.97 - 07.00 2.0, 103 kW 07.95 - 08.99 2.0 T, 118 kW 10.97 - 07.00 1.9 TD 07.95 - 08.99 1.9 DI, 70 kW 03.99 - 07.00		
1.6, 80 kW 03.99 - 12.03 1.8, 90 kW 03.99 - 12.03 1.8 i, 92 kW 03.98 - 12.03 2.0, 100 kW 07.95 - 12.03 2.0 T, 121 kW 07.00 - 06.01 2.0 T4 07.00 - 12.03 1.9 DI, 75 kW 07.00 - 12.03 1.9 DI, 85 kW 07.00 - 12.03	->12.2000	
Faltenbaldsatz, Lenkung / Bellow Kit, steering system Innendurchmesser 1 [mm] / Inner Diameter 1 [mm]:11 Innendurchmesser 2 [mm] / Inner Diameter 2 [mm]:41		30220 3 345 796
ALL TYPES		

S40 II

01.04 -



Spurstangenkopf / Tie-rod End Gewindemaß / Thread Size:M10x1,5 Gewindemaß 2 / Thread Measurement 2:M 16x1,5 ALL TYPES		30462 274 500
Spurstangenkopf / Tie-rod End Gewindemaß / Thread Size:M10x1,5 Gewindemaß 2 / Thread Measurement 2:M 16x1,5 ALL TYPES		30463 274 501
Reparatursatz,Trag-/Führungsgelenk Repair Kit, support/ steering link Gewindemaß / Thread Size:M14x1,5 ALL TYPES		30461
Stange/Strebe, Stabilisator / Rod/Strut, stabiliser Pendelstange / Suspension Rod Länge innen [mm] / Inner Length [mm]:298,1 ALL TYPES		29499 8 623 576
 Achskörperlager / Mounting, axle body ALL TYPES		29794 30 666 821
		











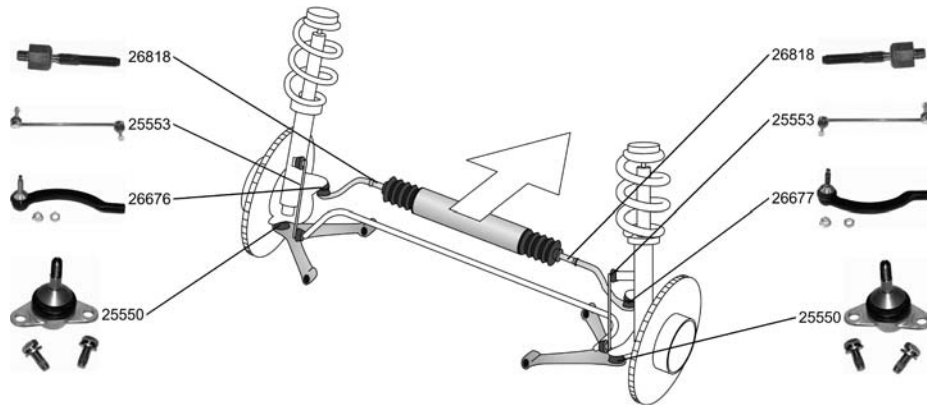





OE

VOLVO

S60

11.00 -



<p>Spurstangenkopf / Tie-rod End mit Zubehör / With accessories</p> <p>ALL TYPES ausser/except for : 2.4 D, 93 kW 09.05 - 2.4 D5, 136 kW 09.05 -</p>	<p></p> <p>für / for:SMI für / for:ZF 01.2001-></p>	<p>26676 274 496</p> 
<p>Spurstangenkopf / Tie-rod End mit Zubehör / With accessories</p> <p>ALL TYPES ausser/except for : 2.4 D, 93 kW 09.05 - 2.4 D5, 136 kW 09.05 -</p>	<p></p> <p>für / for:SMI für / for:ZF 01.2001-></p>	<p>26677 274 497</p> 
<p>Axialgelenk, Spurstange / Axial Rod, tie rod</p> <p>ALL TYPES ausser/except for : 2.4 D, 93 kW 09.05 - 2.4 D5, 136 kW 09.05 -</p>	<p></p> <p>für / for:ZF 01.2004-></p>	<p>26818 274 353</p> 
<p>Trag-/Führungsgelenk / Support-/ Steering Link mit Zubehör / With accessories Gewindemaß / Thread Size:M12x1,75 Konusmaß [mm] / Cone Size [mm]:12,5</p> <p>ALL TYPES ausser/except for : 2.4 D, 93 kW 09.05 - 2.4 D5, 136 kW 09.05 -</p>	<p></p>	<p>25550 274 548</p> 
<p>Lagerung, Lenker / Mounting, wishbone</p> <p>ALL TYPES ausser/except for : 2.4 D, 93 kW 09.05 - 2.4 D5, 136 kW 09.05 -</p>	<p></p>	<p>26600 9 443 882</p> 
<p>Stange/Strebe, Stabilisator / Rod/Strut, stabiliser Pendelstange / Suspension Rod mit Zubehör / With accessories Gewindeart: mit Rechtsgewinde / Thread Type: with right-hand thread Gewindemaß / Thread Size:M10 Gewindemaß / Thread Size:M12</p> <p>ALL TYPES ausser/except for : 2.4 D, 93 kW 09.05 - 2.4 D5, 136 kW 09.05 -</p>	<p></p>	<p>25553 30 714 685</p> 
<p>Faltenbalgsatz, Lenkung / Bellow Kit, steering system Innendurchmesser 1 [mm] / Inner Diameter 1 [mm]:14 Innendurchmesser 2 [mm] / Inner Diameter 2 [mm]:50</p> <p>ALL TYPES ausser/except for : 2.4 D, 93 kW 09.05 - 2.4 D5, 136 kW 09.05 -</p>	<p></p>	<p>30249 272 418</p>



VOLVO

S60

11.00 -

<p> Lagerung, Lenker / Mounting, wishbone</p> <table border="0"> <tr><td>2.0 T</td><td>09.01 -</td></tr> <tr><td>T5</td><td>11.00 -</td></tr> <tr><td>2.4</td><td>11.00 -</td></tr> <tr><td>2.4 T5</td><td>04.04 -</td></tr> <tr><td>2.4 Bifuel</td><td>06.02 -</td></tr> <tr><td>2.4 T</td><td>11.00 -</td></tr> <tr><td>2.4 T AWD</td><td>11.01 -</td></tr> <tr><td>2.5 T</td><td>02.04 -</td></tr> <tr><td>2.4 D, 96 kW</td><td>12.01 -</td></tr> <tr><td>2.4 D5, 120 kW</td><td>07.01 -</td></tr> </table>	2.0 T	09.01 -	T5	11.00 -	2.4	11.00 -	2.4 T5	04.04 -	2.4 Bifuel	06.02 -	2.4 T	11.00 -	2.4 T AWD	11.01 -	2.5 T	02.04 -	2.4 D, 96 kW	12.01 -	2.4 D5, 120 kW	07.01 -	<p>▼↔</p>	<p>26596 9 492 181</p> 
2.0 T	09.01 -																					
T5	11.00 -																					
2.4	11.00 -																					
2.4 T5	04.04 -																					
2.4 Bifuel	06.02 -																					
2.4 T	11.00 -																					
2.4 T AWD	11.01 -																					
2.5 T	02.04 -																					
2.4 D, 96 kW	12.01 -																					
2.4 D5, 120 kW	07.01 -																					
<p>Lagerung, Lenker / Mounting, wishbone</p> <table border="0"> <tr><td>2.0 T</td><td>09.01 -</td></tr> <tr><td>T5</td><td>11.00 -</td></tr> <tr><td>2.4</td><td>11.00 -</td></tr> <tr><td>2.4 T5</td><td>04.04 -</td></tr> <tr><td>2.4 Bifuel</td><td>06.02 -</td></tr> <tr><td>2.4 T</td><td>11.00 -</td></tr> <tr><td>2.4 T AWD</td><td>11.01 -</td></tr> <tr><td>2.5 T</td><td>02.04 -</td></tr> <tr><td>2.4 D, 96 kW</td><td>12.01 -</td></tr> <tr><td>2.4 D5, 120 kW</td><td>07.01 -</td></tr> </table>	2.0 T	09.01 -	T5	11.00 -	2.4	11.00 -	2.4 T5	04.04 -	2.4 Bifuel	06.02 -	2.4 T	11.00 -	2.4 T AWD	11.01 -	2.5 T	02.04 -	2.4 D, 96 kW	12.01 -	2.4 D5, 120 kW	07.01 -	<p>↔↻</p>	<p>26599 9 127 363</p> 
2.0 T	09.01 -																					
T5	11.00 -																					
2.4	11.00 -																					
2.4 T5	04.04 -																					
2.4 Bifuel	06.02 -																					
2.4 T	11.00 -																					
2.4 T AWD	11.01 -																					
2.5 T	02.04 -																					
2.4 D, 96 kW	12.01 -																					
2.4 D5, 120 kW	07.01 -																					
<p>Stange/Strebe, Stabilisator / Rod/Strut, stabiliser Pendelstange / Suspension Rod</p> <p>ALL TYPES ausser/except for :</p> <table border="0"> <tr><td>2.4 D, 93 kW</td><td>09.05 -</td></tr> <tr><td>2.4 D5, 136 kW</td><td>09.05 -</td></tr> </table>	2.4 D, 93 kW	09.05 -	2.4 D5, 136 kW	09.05 -	<p>↔</p>	<p>26793 30 714 678</p> 																
2.4 D, 93 kW	09.05 -																					
2.4 D5, 136 kW	09.05 -																					
<p>Achskörperlager / Mounting, axle body</p> <p>ALL TYPES ausser/except for :</p> <table border="0"> <tr><td>2.4 D, 93 kW</td><td>09.05 -</td></tr> <tr><td>2.4 D5, 136 kW</td><td>09.05 -</td></tr> </table>	2.4 D, 93 kW	09.05 -	2.4 D5, 136 kW	09.05 -	<p>▲↔↑</p>	<p>29505 9 169 204</p> 																
2.4 D, 93 kW	09.05 -																					
2.4 D5, 136 kW	09.05 -																					
<p>Achskörperlager / Mounting, axle body</p> <p>ALL TYPES ausser/except for :</p> <table border="0"> <tr><td>2.4 D, 93 kW</td><td>09.05 -</td></tr> <tr><td>2.4 D5, 136 kW</td><td>09.05 -</td></tr> </table>	2.4 D, 93 kW	09.05 -	2.4 D5, 136 kW	09.05 -	<p>▲↔↑ 01.2002-></p>	<p>29506 9 157 572</p> 																
2.4 D, 93 kW	09.05 -																					
2.4 D5, 136 kW	09.05 -																					
<p>Achskörperlager / Mounting, axle body</p> <p>ALL TYPES ausser/except for :</p> <table border="0"> <tr><td>2.4 D, 93 kW</td><td>09.05 -</td></tr> <tr><td>2.4 D5, 136 kW</td><td>09.05 -</td></tr> </table>	2.4 D, 93 kW	09.05 -	2.4 D5, 136 kW	09.05 -	<p>▼↔↑ 01.2002-></p>	<p>29507 9 157 576</p> 																
2.4 D, 93 kW	09.05 -																					
2.4 D5, 136 kW	09.05 -																					
<p>Achskörperlager / Mounting, axle body</p> <p>ALL TYPES ausser/except for :</p> <table border="0"> <tr><td>2.4 D, 93 kW</td><td>09.05 -</td></tr> <tr><td>2.4 D5, 136 kW</td><td>09.05 -</td></tr> </table>	2.4 D, 93 kW	09.05 -	2.4 D5, 136 kW	09.05 -	<p>▲↔↓</p>	<p>29508 9 465 975</p> 																
2.4 D, 93 kW	09.05 -																					
2.4 D5, 136 kW	09.05 -																					
<p>Achskörperlager / Mounting, axle body</p> <p>ALL TYPES ausser/except for :</p> <table border="0"> <tr><td>2.4 D, 93 kW</td><td>09.05 -</td></tr> <tr><td>2.4 D5, 136 kW</td><td>09.05 -</td></tr> </table>	2.4 D, 93 kW	09.05 -	2.4 D5, 136 kW	09.05 -	<p>▲↔↓</p>	<p>29509 9 173 761</p> 																
2.4 D, 93 kW	09.05 -																					
2.4 D5, 136 kW	09.05 -																					
<p>Achskörperlager / Mounting, axle body</p> <p>ALL TYPES ausser/except for :</p> <table border="0"> <tr><td>2.4 D, 93 kW</td><td>09.05 -</td></tr> <tr><td>2.4 D5, 136 kW</td><td>09.05 -</td></tr> </table>	2.4 D, 93 kW	09.05 -	2.4 D5, 136 kW	09.05 -	<p>▼↔↻</p>	<p>29510 30 645 401</p> 																
2.4 D, 93 kW	09.05 -																					
2.4 D5, 136 kW	09.05 -																					











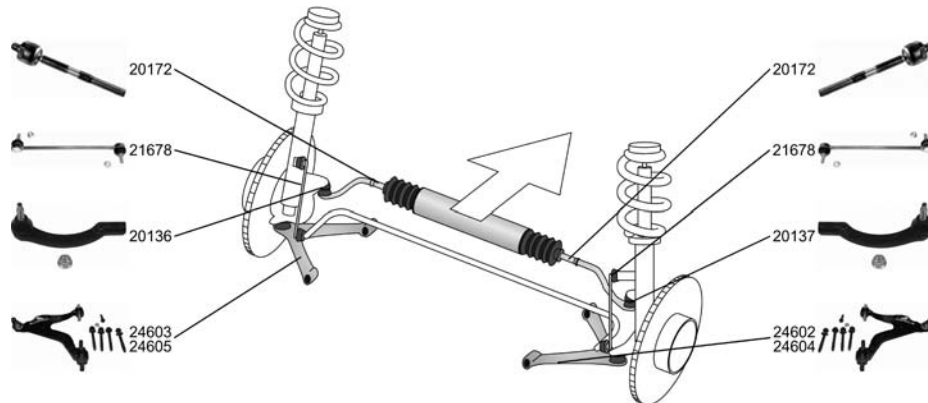







OE

VOLVO

S70

01.97 - 11.00





















Spurstangenkopf / Tie-rod End mit Zubehör / With accessories ALL TYPES ausser/except for : 2.0 T 01.98 - 2.4 01.98 -		20136 271 598 
Spurstangenkopf / Tie-rod End mit Zubehör / With accessories ALL TYPES ausser/except for : 2.0 T 01.98 - 2.4 01.98 -		20137 271 599 
Axialgelenk, Spurstange / Axial Rod, tie rod Achsausführung / Axle Version:TRW Gewindemaß / Thread Size:M14x2 Gewindeart: mit Rechtsgewinde / Thread Type: with right-hand thread ALL TYPES ausser/except for : 2.0 T 01.98 - 2.4 01.98 -		20172 3 546 266 
Lenker, Radaufhängung / Track Control Arm mit Gummilager / with rubber mounting 2.5 TDI 01.97 - 11.00		24602 8 628 498 
Lenker, Radaufhängung / Track Control Arm mit Gummilager / with rubber mounting 2.5 TDI 01.97 - 11.00		24603 8 628 497 
Lenker, Radaufhängung / Track Control Arm mit Gummilager / with rubber mounting ALL TYPES ausser/except for : 2.0 T 01.98 - 2.4 01.98 -		24604 8 628 496 
Lenker, Radaufhängung / Track Control Arm mit Gummilager / with rubber mounting ALL TYPES ausser/except for : 2.0 T 01.98 - 2.4 01.98 -		24605 8 628 495 
Lagerung, Lenker / Mounting, wishbone ALL TYPES ausser/except for : 2.0 T 01.98 - 2.4 01.98 - 2.5 TDI 01.97 - 11.00		I12/A32 22652 271 631 



VOLVO

S70



01.97 - 11.00

	Stange/Strebe, Stabilisator / Rod/Strut, stabiliser Pendelstange / Suspension Rod		21678	30 714 686
	ALL TYPES ausser/except for : 2.0 T 01.98 - 2.4 01.98 -			
	Faltenbalgsatz, Lenkung / Bellow Kit, steering system		30233	9 191 409
	ALL TYPES ausser/except for : 2.0 T 01.98 - 2.4 01.98 -	für / for: SMI		
	Faltenbalgsatz, Lenkung / Bellow Kit, steering system		30242	271 601
	ALL TYPES ausser/except for : 2.0 T 01.98 - 2.4 01.98 -	für / for: TRW		
	Lagerung, Lenker / Mounting, wishbone		27705	9 181 013
	ALL TYPES ausser/except for : 2.0 T 01.98 - 2.4 01.98 -			
	Lagerung, Lenker / Mounting, wishbone		27706	9 181 027
	ALL TYPES ausser/except for : 2.0 T 01.98 - 2.4 01.98 -			
	Stange/Strebe, Stabilisator / Rod/Strut, stabiliser Pendelstange / Suspension Rod		26793	30 714 678
	ALL TYPES ausser/except for : 2.0 T 01.98 - 2.4 01.98 -			
	Achskörperlager / Mounting, axle body		26815	3 516 122
	ALL TYPES ausser/except for : 2.0 T 01.98 - 2.4 01.98 -			

S80

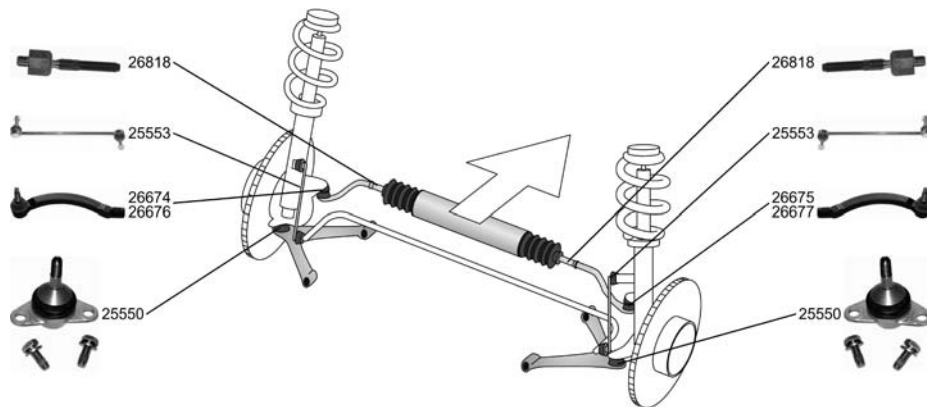
05.98 -



	Spurstangenkopf / Tie-rod End mit Zubehör / With accessories		26674	272 416
	2.0 06.98 - 2.0 T, 166 kW 06.98 - 2.4 01.99 - 2.8 T6 05.98 - 2.9 05.98 - 2.5 TDI 01.99 -	->12.1999		



















OE

VOLVO

S80

05.98 -



 Spurstangenkopf / Tie-rod End mit Zubehör / With accessories		26675 272 417
2.0 2.0 T, 166 kW 2.4 2.8 T6 2.9 2.5 TDI	06.98 - 06.98 - 01.99 - 05.98 - 05.98 - 01.99 -	->12.1999 
Spurstangenkopf / Tie-rod End mit Zubehör / With accessories		26676 274 496
2.0 2.0 T 2.4 2.8 T6 2.9 2.5 TDI	06.98 - 06.98 - 01.99 - 05.98 - 05.98 - 01.99 -	für / for:ZF für / for:SMI 01.2000-> 
2.4 Bifuel 2.4 T 2.5 T 2.5 T AWD 3.0 3.0 T6 2.4 D 2.4 D5	09.01 - 06.00 - 03.03 - 07.03 - 06.01 - 06.01 - 10.01 - 08.01 -	für / for:ZF für / for:SMI 
Spurstangenkopf / Tie-rod End mit Zubehör / With accessories		26677 274 497
2.0 2.0 T 2.4 2.8 T6 2.9 2.5 TDI	06.98 - 06.98 - 01.99 - 05.98 - 05.98 - 01.99 -	für / for:SMI für / for:ZF 01.2000-> 
2.4 Bifuel 2.4 T 2.5 T 2.5 T AWD 3.0 3.0 T6 2.4 D 2.4 D5	09.01 - 06.00 - 03.03 - 07.03 - 06.01 - 06.01 - 10.01 - 08.01 -	für / for:SMI für / for:ZF 
Axialgelenk, Spurstange / Axial Rod, tie rod		26818 274 353
ALL TYPES	für / for:ZF 01.2004->	
Trag-/Führungsgelenk / Support-/ Steering Link mit Zubehör / With accessories Gewindemaß / Thread Size:M12x1,75 Konusmaß [mm] / Cone Size [mm]:12,5		25550 274 548
ALL TYPES ausser/except for : 2.5 T 2.5 T AWD	03.03 - 07.03 -	
Lagerung, Lenker / Mounting, wishbone		26600 9 443 882
ALL TYPES	Chass. 116 811->	
Lagerung, Lenker / Mounting, wishbone		30339 9 465 971
ALL TYPES	->Chass. 116 810	



OE









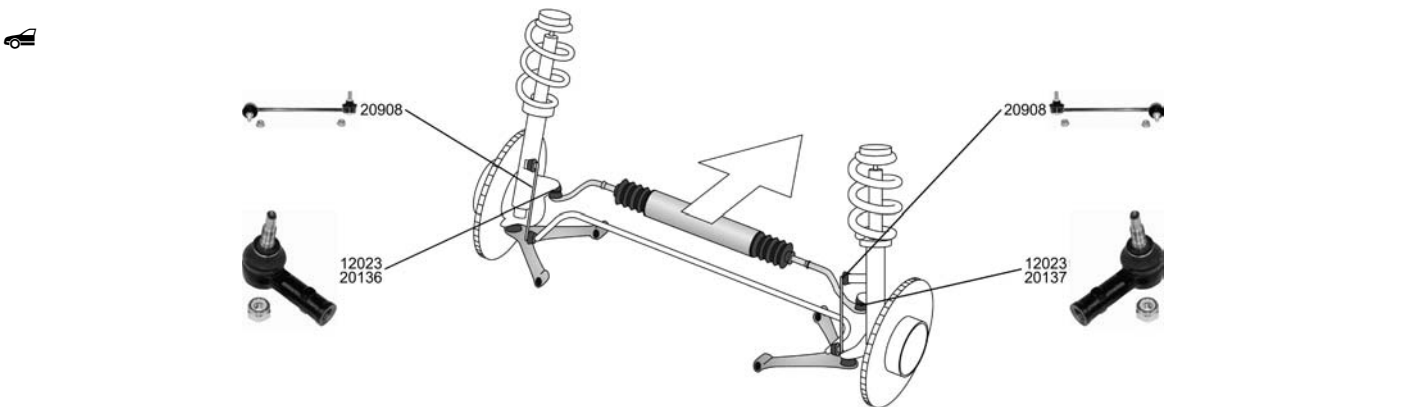





VOLVO

S80 05.98 -

 Achskörperlager / Mounting, axle body ALL TYPES		29510 30 645 401 
---	---	---

S90 01.97 - 05.98

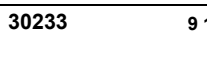

Spurstangenkopf / Tie-rod End Konusmaß [mm] / Cone Size [mm]:14 Gewindart: mit Rechtsgewinde / Thread Type: with right-hand thread Innengewinde [mm] / Inner Thread [mm]:M14x2 Gewindemaß / Thread Size:M14x2 für Lenkgetriebe-ID / For steering rack ID:ZF/CAM/TRW ALL TYPES		12023 3 516 944 
Spurstangenkopf / Tie-rod End mit Zubehör / With accessories ALL TYPES		20136 271 598 
Spurstangenkopf / Tie-rod End mit Zubehör / With accessories ALL TYPES		20137 271 599 
Axialgelenk, Spurstange / Axial Rod, tie rod Achsausführung / Axle Version:CAM Gewindemaß / Thread Size:M14x2 Gewindart: mit Rechtsgewinde / Thread Type: with right-hand thread ALL TYPES		20133 9 140 504 
Lagerung, Lenker / Mounting, wishbone ALL TYPES		25996 6 819 537 
Lagerung, Lenker / Mounting, wishbone ALL TYPES		29543 9 191 537 
Stange/Strebe, Stabilisator / Rod/Strut, stabiliser Pendelstange / Suspension Rod ALL TYPES		20908 272 991 
Faltenbalgsatz, Lenkung / Bellow Kit, steering system ALL TYPES		30233 9 191 409 



VOLVO

S90





01.97 - 05.98

	Faltenbalgsatz, Lenkung / Bellow Kit, steering system		30242	271 601
	ALL TYPES		für / for:TRW	

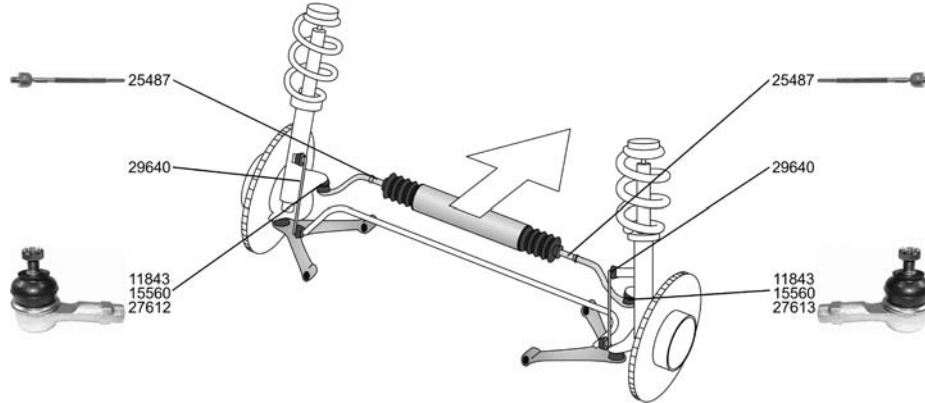
V40 Kombi/Estate/Break (VW)

07.95 -



Spurstangenkopf / Tie-rod End Gewindeart: mit Rechtsgewinde / Thread Type: with right-hand thread Innengewinde [mm] / Inner Thread [mm]:M12x1,25			11843 30 875 012 
1.6, 77 kW 1.8, 85 kW 1.9 T4 2.0, 103 kW 2.0 T, 118 kW 1.9 TD 1.9 DI, 70 kW	12.95 - 08.99 07.95 - 08.99 05.97 - 07.00 07.95 - 08.99 10.97 - 07.00 07.95 - 08.99 03.99 - 07.00		
1.6, 80 kW 1.8, 90 kW 1.8 i, 92 kW 2.0, 100 kW 2.0 T, 120 kW 2.0 T, 121 kW 2.0 T4 1.9 DI, 75 kW 1.9 DI, 85 kW	03.99 - 03.99 - 03.98 - 07.95 - 06.01 - 07.00 - 06.01 07.00 - 07.00 - 07.00 -	->12.2000	
Spurstangenkopf / Tie-rod End Gewindeart: mit Rechtsgewinde / Thread Type: with right-hand thread Innengewinde [mm] / Inner Thread [mm]:M12x1,25			15560 
1.6, 77 kW 1.8, 85 kW 1.9 T4 2.0, 103 kW 2.0 T, 118 kW 1.9 TD 1.9 DI, 70 kW	12.95 - 08.99 07.95 - 08.99 05.97 - 07.00 07.95 - 08.99 10.97 - 07.00 07.95 - 08.99 03.99 - 07.00		
1.6, 80 kW 1.8, 90 kW 1.8 i, 92 kW 2.0, 100 kW 2.0 T, 120 kW 2.0 T, 121 kW 2.0 T4 1.9 DI, 75 kW 1.9 DI, 85 kW	03.99 - 03.99 - 03.98 - 07.95 - 06.01 - 07.00 - 06.01 07.00 - 07.00 - 07.00 -	->12.2000	











OE

VOLVO

V40 Kombi/Estate/Break (VW)

07.95 -







<p> Spurstangenkopf / Tie-rod End radseitig / Wheel Side Konusmaß [mm] / Cone Size [mm]:15,3 Aussengewinde [mm] / Outer Thread [mm]:M10x1,25 Innengewinde [mm] / Inner Thread [mm]:M14x1,5 mit Zubehör / With accessories</p>	<p></p>	<p>27612 274 225</p>
<p>1.6, 80 kW 03.99 - 1.8, 90 kW 03.99 - 1.8 i, 92 kW 03.98 - 2.0, 100 kW 07.95 -</p>	<p>07.2000-></p>	
<p>1.8 i, 90 kW 06.01 - 2.0 T, 120 kW 06.01 - 2.0 T, 121 kW 07.00 - 06.01 2.0 T4 07.00 - 1.9 DI, 75 kW 07.00 - 1.9 DI, 85 kW 07.00 -</p>		
<p>Spurstangenkopf / Tie-rod End radseitig / Wheel Side Konusmaß [mm] / Cone Size [mm]:15,3 Aussengewinde [mm] / Outer Thread [mm]:M10x1,25 Innengewinde [mm] / Inner Thread [mm]:M14x1,5 mit Zubehör / With accessories</p>	<p></p>	<p>27613 274 226</p> 
<p>1.6, 80 kW 03.99 - 1.8, 90 kW 03.99 - 1.8 i, 92 kW 03.98 - 2.0, 100 kW 07.95 -</p>	<p>07.2000-></p>	
<p>1.8 i, 90 kW 06.01 - 2.0 T, 120 kW 06.01 - 2.0 T, 121 kW 07.00 - 06.01 2.0 T4 07.00 - 1.9 DI, 75 kW 07.00 - 1.9 DI, 85 kW 07.00 -</p>		
<p>Axialgelenk, Spurstange / Axial Rod, tie rod</p>	<p></p>	<p>25487 3 345 797</p>
<p>1.6, 77 kW 12.95 - 08.99 1.8, 85 kW 07.95 - 08.99 1.9 T4 05.97 - 07.00 2.0, 103 kW 07.95 - 08.99 2.0 T, 118 kW 10.97 - 07.00 1.9 TD 07.95 - 08.99 1.9 DI, 70 kW 03.99 - 07.00</p>		
<p>1.6, 80 kW 03.99 - 1.8, 90 kW 03.99 - 1.8 i, 92 kW 03.98 - 2.0, 100 kW 07.95 - 2.0 T, 121 kW 07.00 - 06.01 2.0 T4 07.00 - 1.9 DI, 75 kW 07.00 - 1.9 DI, 85 kW 07.00 -</p>	<p>->12.2000</p>	
<p>Lagerung, Lenker / Mounting, wishbone</p>	<p></p>	<p>25997 30 818 467</p>
<p>1.6, 77 kW 12.95 - 08.99 1.8, 85 kW 07.95 - 08.99 1.8 i, 90 kW 06.01 - 2.0, 103 kW 07.95 - 08.99 2.0 T, 120 kW 06.01 - 1.9 TD 07.95 - 08.99</p>		
<p>1.6, 80 kW 03.99 - 1.8, 90 kW 03.99 - 1.8 i, 92 kW 03.98 - 2.0, 100 kW 07.95 -</p>	<p>01.2001 - 12.1999</p>	
<p>1.9 T4 05.97 - 07.00 2.0 T, 118 kW 10.97 - 07.00 1.9 DI, 70 kW 03.99 - 07.00</p>	<p>->12.1999</p>	
<p>2.0 T, 121 kW 07.00 - 06.01 2.0 T4 07.00 - 1.9 DI, 75 kW 07.00 - 1.9 DI, 85 kW 07.00 -</p>	<p>01.2001-></p>	



VOLVO

V40 Kombi/Estate/Break (VW)





07.95 -

	Lagerung, Lenker / Mounting, wishbone			26588	30 887 024
	1.6, 80 kW 1.8, 90 kW 1.8 i, 92 kW 2.0, 100 kW 1.9 T4 2.0 T, 118 kW 1.9 DI, 70 kW 2.0 T, 121 kW 2.0 T4 1.9 DI, 75 kW 1.9 DI, 85 kW	03.99 - 03.99 - 03.98 - 07.95 - 05.97 - 07.00 10.97 - 07.00 03.99 - 07.00 07.00 - 06.01 07.00 - 07.00 - 07.00 -	01.2000 - 12.2000 01.2000-> ->12.2000		
	Stange/Strebe, Stabilisator / Rod/Strut, stabiliser			29640	30 884 358
	Pendelstange / Suspension Rod Gewindemaß / Thread Size:M10x1,25 1.6, 77 kW 1.8, 85 kW 1.9 T4 2.0, 103 kW 2.0 T, 118 kW 1.9 TD 1.9 DI, 70 kW 1.6, 80 kW 1.8, 90 kW 1.8 i, 92 kW 2.0, 100 kW 2.0 T, 121 kW 2.0 T4 1.9 DI, 75 kW 1.9 DI, 85 kW	12.95 - 08.99 07.95 - 08.99 05.97 - 07.00 07.95 - 08.99 10.97 - 07.00 07.95 - 08.99 03.99 - 07.00 03.99 - 03.99 - 03.98 - 07.95 - 07.00 - 06.01 07.00 - 07.00 - 07.00 -	->12.2000		
	Faltenbalgsatz, Lenkung / Bellow Kit, steering system			30220	3 345 796
	Innendurchmesser 1 [mm] / Inner Diameter 1 [mm]:11 Innendurchmesser 2 [mm] / Inner Diameter 2 [mm]:41 ALL TYPES				

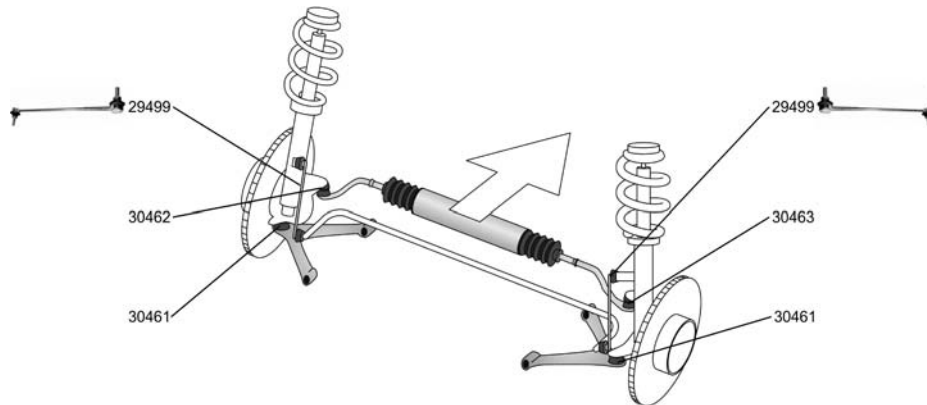
V50

04.04 -









	Spurstangenkopf / Tie-rod End			30462	274 500
	Gewindemaß / Thread Size:M10x1,5 Gewindemaß 2 / Thread Measurement 2:M 16x1,5 ALL TYPES				
	Spurstangenkopf / Tie-rod End			30463	274 501
	Gewindemaß / Thread Size:M10x1,5 Gewindemaß 2 / Thread Measurement 2:M 16x1,5 ALL TYPES				
	Reparatursatz,Trag-/Führungsgelenk			30461	
	Repair Kit, support/ steering link Gewindemaß / Thread Size:M14x1,5 ALL TYPES				



OE









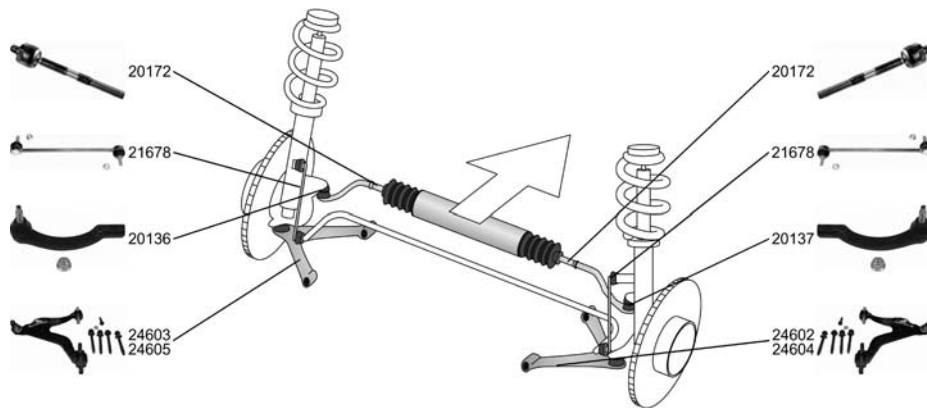

VOLVO

V50 04.04 -

 Stange/Strebe, Stabilisator / Rod/Strut, stabiliser Pendelstange / Suspension Rod Länge innen [mm] / Inner Length [mm]:298,1 ALL TYPES		29499 8 623 576 
 Achskörperlager / Mounting, axle body ALL TYPES		29794 30 666 821 

V70 I Kombi/Estate/Break 01.97 - 03.00



















Spurstangenkopf / Tie-rod End mit Zubehör / With accessories ALL TYPES ausser/except for : 1.9 01.97 - 03.00 2.0 T 01.98 - 2.3 T 01.97 -		20136 271 598 
Spurstangenkopf / Tie-rod End mit Zubehör / With accessories ALL TYPES ausser/except for : 1.9 01.97 - 03.00 2.0 T 01.98 - 2.3 T 01.97 -		20137 271 599 
Axialgelenk, Spurstange / Axial Rod, tie rod Achsausführung / Axle Version:TRW Gewindemaß / Thread Size:M14x2 Gewindeart: mit Rechtsgewinde / Thread Type: with right-hand thread ALL TYPES ausser/except for : 1.9 01.97 - 03.00 2.0 T 01.98 - 2.3 T 01.97 -		20172 3 546 266 
Lenker, Radaufhängung / Track Control Arm mit Gummilager / with rubber mounting 2.5 TDI 01.97 - 05.00		24602 8 628 498 
Lenker, Radaufhängung / Track Control Arm mit Gummilager / with rubber mounting 2.5 TDI 01.97 - 05.00		24603 8 628 497 



VOLVO

V70 | Kombi/Estate/Break

01.97 - 03.00



	Lenker, Radaufhängung / Track Control Arm mit Gummilager / with rubber mounting		24604 8 628 496																												
	<table border="0"> <tr><td>2.0</td><td>01.97 - 03.00</td></tr> <tr><td>2.0 Turbo</td><td>01.97 - 03.00</td></tr> <tr><td>2.0 Turbo AWD</td><td>01.97 - 03.00</td></tr> <tr><td>2.3 T-5</td><td>01.97 - 03.00</td></tr> <tr><td>2.3 T-5 AWD</td><td>01.97 - 03.00</td></tr> <tr><td>2.3 Turbo</td><td>01.97 - 03.00</td></tr> <tr><td>2.3 T AWD</td><td>04.97 - 03.00</td></tr> <tr><td>2.4 Bifuel</td><td>08.99 - 03.00</td></tr> <tr><td>2.4</td><td>01.97 - 05.00</td></tr> <tr><td>2.4 Turbo</td><td>01.97 - 03.00</td></tr> <tr><td>2.5</td><td>01.97 - 03.00</td></tr> <tr><td>2.5 Bifuel</td><td>10.98 - 08.99</td></tr> <tr><td>2.5 Turbo AWD</td><td>01.97 - 05.00</td></tr> <tr><td>2.5 AWD</td><td>03.99 - 03.00</td></tr> </table>	2.0	01.97 - 03.00	2.0 Turbo	01.97 - 03.00	2.0 Turbo AWD	01.97 - 03.00	2.3 T-5	01.97 - 03.00	2.3 T-5 AWD	01.97 - 03.00	2.3 Turbo	01.97 - 03.00	2.3 T AWD	04.97 - 03.00	2.4 Bifuel	08.99 - 03.00	2.4	01.97 - 05.00	2.4 Turbo	01.97 - 03.00	2.5	01.97 - 03.00	2.5 Bifuel	10.98 - 08.99	2.5 Turbo AWD	01.97 - 05.00	2.5 AWD	03.99 - 03.00		
2.0	01.97 - 03.00																														
2.0 Turbo	01.97 - 03.00																														
2.0 Turbo AWD	01.97 - 03.00																														
2.3 T-5	01.97 - 03.00																														
2.3 T-5 AWD	01.97 - 03.00																														
2.3 Turbo	01.97 - 03.00																														
2.3 T AWD	04.97 - 03.00																														
2.4 Bifuel	08.99 - 03.00																														
2.4	01.97 - 05.00																														
2.4 Turbo	01.97 - 03.00																														
2.5	01.97 - 03.00																														
2.5 Bifuel	10.98 - 08.99																														
2.5 Turbo AWD	01.97 - 05.00																														
2.5 AWD	03.99 - 03.00																														
	Lenker, Radaufhängung / Track Control Arm mit Gummilager / with rubber mounting		24605 8 628 495																												
	<table border="0"> <tr><td>2.0</td><td>01.97 - 03.00</td></tr> <tr><td>2.0 Turbo</td><td>01.97 - 03.00</td></tr> <tr><td>2.0 Turbo AWD</td><td>01.97 - 03.00</td></tr> <tr><td>2.3 T-5</td><td>01.97 - 03.00</td></tr> <tr><td>2.3 T-5 AWD</td><td>01.97 - 03.00</td></tr> <tr><td>2.3 Turbo</td><td>01.97 - 03.00</td></tr> <tr><td>2.3 T AWD</td><td>04.97 - 03.00</td></tr> <tr><td>2.4 Bifuel</td><td>08.99 - 03.00</td></tr> <tr><td>2.4</td><td>01.97 - 05.00</td></tr> <tr><td>2.4 Turbo</td><td>01.97 - 03.00</td></tr> <tr><td>2.5</td><td>01.97 - 03.00</td></tr> <tr><td>2.5 Bifuel</td><td>10.98 - 08.99</td></tr> <tr><td>2.5 Turbo AWD</td><td>01.97 - 05.00</td></tr> <tr><td>2.5 AWD</td><td>03.99 - 03.00</td></tr> </table>	2.0	01.97 - 03.00	2.0 Turbo	01.97 - 03.00	2.0 Turbo AWD	01.97 - 03.00	2.3 T-5	01.97 - 03.00	2.3 T-5 AWD	01.97 - 03.00	2.3 Turbo	01.97 - 03.00	2.3 T AWD	04.97 - 03.00	2.4 Bifuel	08.99 - 03.00	2.4	01.97 - 05.00	2.4 Turbo	01.97 - 03.00	2.5	01.97 - 03.00	2.5 Bifuel	10.98 - 08.99	2.5 Turbo AWD	01.97 - 05.00	2.5 AWD	03.99 - 03.00		
2.0	01.97 - 03.00																														
2.0 Turbo	01.97 - 03.00																														
2.0 Turbo AWD	01.97 - 03.00																														
2.3 T-5	01.97 - 03.00																														
2.3 T-5 AWD	01.97 - 03.00																														
2.3 Turbo	01.97 - 03.00																														
2.3 T AWD	04.97 - 03.00																														
2.4 Bifuel	08.99 - 03.00																														
2.4	01.97 - 05.00																														
2.4 Turbo	01.97 - 03.00																														
2.5	01.97 - 03.00																														
2.5 Bifuel	10.98 - 08.99																														
2.5 Turbo AWD	01.97 - 05.00																														
2.5 AWD	03.99 - 03.00																														
	Lagerung, Lenker / Mounting, wishbone		I12/A32 22652 271 631																												
	<table border="0"> <tr><td colspan="2">ALL TYPES ausser/except for :</td></tr> <tr><td>1.9</td><td>01.97 - 03.00</td></tr> <tr><td>2.0 T</td><td>01.98 -</td></tr> <tr><td>2.3 T</td><td>01.97 -</td></tr> </table>	ALL TYPES ausser/except for :		1.9	01.97 - 03.00	2.0 T	01.98 -	2.3 T	01.97 -																						
ALL TYPES ausser/except for :																															
1.9	01.97 - 03.00																														
2.0 T	01.98 -																														
2.3 T	01.97 -																														
	Stange/Strebe, Stabilisator / Rod/Strut, stabiliser Pendelstange / Suspension Rod		21678 30 714 686																												
	<table border="0"> <tr><td colspan="2">ALL TYPES ausser/except for :</td></tr> <tr><td>1.9</td><td>01.97 - 03.00</td></tr> <tr><td>2.0 T</td><td>01.98 -</td></tr> <tr><td>2.3 T</td><td>01.97 -</td></tr> </table>	ALL TYPES ausser/except for :		1.9	01.97 - 03.00	2.0 T	01.98 -	2.3 T	01.97 -																						
ALL TYPES ausser/except for :																															
1.9	01.97 - 03.00																														
2.0 T	01.98 -																														
2.3 T	01.97 -																														
	Faltenbalgsatz, Lenkung / Bellow Kit, steering system		30233 9 191 409																												
	<table border="0"> <tr><td colspan="2">ALL TYPES ausser/except for :</td></tr> <tr><td>1.9</td><td>01.97 - 03.00</td></tr> <tr><td>2.0 T</td><td>01.98 -</td></tr> <tr><td>2.3 T</td><td>01.97 -</td></tr> </table>	ALL TYPES ausser/except for :		1.9	01.97 - 03.00	2.0 T	01.98 -	2.3 T	01.97 -	für / for:SMI																					
ALL TYPES ausser/except for :																															
1.9	01.97 - 03.00																														
2.0 T	01.98 -																														
2.3 T	01.97 -																														
	Faltenbalgsatz, Lenkung / Bellow Kit, steering system		30242 271 601																												
	<table border="0"> <tr><td colspan="2">ALL TYPES ausser/except for :</td></tr> <tr><td>1.9</td><td>01.97 - 03.00</td></tr> <tr><td>2.0 T</td><td>01.98 -</td></tr> <tr><td>2.3 T</td><td>01.97 -</td></tr> </table>	ALL TYPES ausser/except for :		1.9	01.97 - 03.00	2.0 T	01.98 -	2.3 T	01.97 -	für / for:TRW																					
ALL TYPES ausser/except for :																															
1.9	01.97 - 03.00																														
2.0 T	01.98 -																														
2.3 T	01.97 -																														
	Lagerung, Lenker / Mounting, wishbone		27705 9 181 013																												
	<table border="0"> <tr><td colspan="2">ALL TYPES ausser/except for :</td></tr> <tr><td>1.9</td><td>01.97 - 03.00</td></tr> <tr><td>2.0 T</td><td>01.98 -</td></tr> <tr><td>2.3 T</td><td>01.97 -</td></tr> </table>	ALL TYPES ausser/except for :		1.9	01.97 - 03.00	2.0 T	01.98 -	2.3 T	01.97 -																						
ALL TYPES ausser/except for :																															
1.9	01.97 - 03.00																														
2.0 T	01.98 -																														
2.3 T	01.97 -																														
	Lagerung, Lenker / Mounting, wishbone		27706 9 181 027																												
	<table border="0"> <tr><td colspan="2">ALL TYPES ausser/except for :</td></tr> <tr><td>1.9</td><td>01.97 - 03.00</td></tr> <tr><td>2.0 T</td><td>01.98 -</td></tr> <tr><td>2.3 T</td><td>01.97 -</td></tr> </table>	ALL TYPES ausser/except for :		1.9	01.97 - 03.00	2.0 T	01.98 -	2.3 T	01.97 -																						
ALL TYPES ausser/except for :																															
1.9	01.97 - 03.00																														
2.0 T	01.98 -																														
2.3 T	01.97 -																														



OE



VOLVO

V70 I Kombi/Estate/Break 01.97 - 03.00

 Stange/Strebe, Stabilisator / Rod/Strut, stabiliser Pendelstange / Suspension Rod		 26793 30 714 678
	ALL TYPES ausser/except for : 1.9 01.97 - 03.00 2.0 T 01.98 - 2.3 T 01.97 -	
Achskörperlager / Mounting, axle body		 26815 3 516 122
	ALL TYPES ausser/except for : 1.9 01.97 - 03.00 2.0 T 01.98 - 2.3 T 01.97 -	

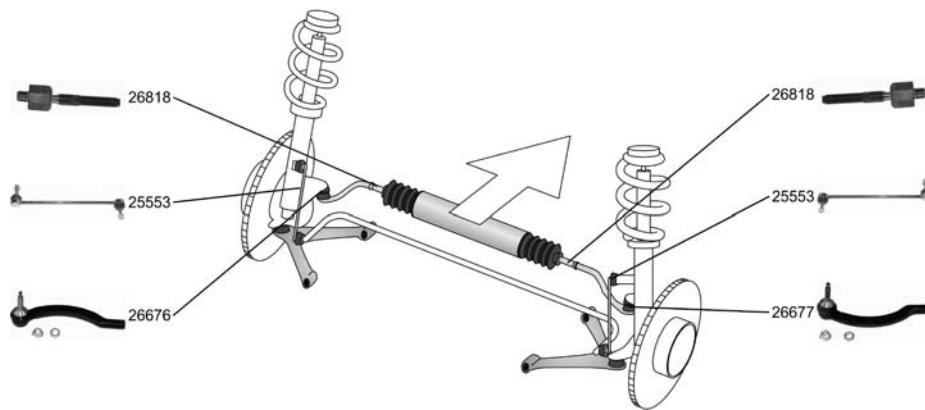
V70 II Kombi/Estate/Break 03.00 -















Spurstangenkopf / Tie-rod End mit Zubehör / With accessories		 26676 274 496
	2.3 T5 03.00 - für / for:SMI 2.4 03.00 - für / for:ZF 2.4 T 03.00 - 01.2001-> 2.5 TDI 03.00 -	
Spurstangenkopf / Tie-rod End mit Zubehör / With accessories		 26677 274 497
	2.0 T 07.01 - für / for:ZF 2.4 T5 04.04 - für / for:SMI 2.4 Bifuel 09.01 - 2.4 T AWD 09.01 - 2.5 T AWD 09.02 - R 2.5 T AWD 03.03 - 2.4 D 12.01 - 2.5 T 04.04 - 2.4 D5, 120 kW 08.01 - 2.4 D5 AWD, 120 kW 03.03 -	
Axialgelenk, Spurstange / Axial Rod, tie rod		 26818 274 353
	ALL TYPES ausser/except for : 2.4 D5, 136 kW 12.05 - 2.4 D5 AWD, 136 kW 12.05 -	



VOLVO

V70 II Kombi/Estate/Break

03.00 -

<p> Lagerung, Lenker / Mounting, wishbone</p> <p>ALL TYPES ausser/except for :</p> <table border="1"> <tr> <td>2.4 D5, 136 kW</td> <td>12.05 -</td> </tr> <tr> <td>2.4 D5 AWD, 136 kW</td> <td>12.05 -</td> </tr> </table>	2.4 D5, 136 kW	12.05 -	2.4 D5 AWD, 136 kW	12.05 -	<p></p>	<p>26600 9 443 882</p> 																		
2.4 D5, 136 kW	12.05 -																							
2.4 D5 AWD, 136 kW	12.05 -																							
<p>Stange/Strebe, Stabilisator / Rod/Strut, stabiliser</p> <p>Pendelstange / Suspension Rod mit Zubehör / With accessories Gewindeart: mit Rechtsgewinde / Thread Type: with right-hand thread Gewindemaß / Thread Size:M10 Gewindemaß / Thread Size:M12</p> <table border="1"> <tr><td>2.0 T</td><td>07.01 -</td></tr> <tr><td>2.3 T5</td><td>03.00 -</td></tr> <tr><td>2.4</td><td>03.00 -</td></tr> <tr><td>2.4 Bifuel</td><td>09.01 -</td></tr> <tr><td>2.4 T</td><td>03.00 -</td></tr> <tr><td>2.4 T AWD</td><td>09.01 -</td></tr> <tr><td>2.5 T AWD</td><td>09.02 -</td></tr> <tr><td>R 2,5 T AWD</td><td>03.03 -</td></tr> <tr><td>2.4 D</td><td>12.01 -</td></tr> <tr><td>2.4 D5, 120 kW</td><td>08.01 -</td></tr> <tr><td>2.5 TDI</td><td>03.00 -</td></tr> </table>	2.0 T	07.01 -	2.3 T5	03.00 -	2.4	03.00 -	2.4 Bifuel	09.01 -	2.4 T	03.00 -	2.4 T AWD	09.01 -	2.5 T AWD	09.02 -	R 2,5 T AWD	03.03 -	2.4 D	12.01 -	2.4 D5, 120 kW	08.01 -	2.5 TDI	03.00 -	<p></p>	<p>25553 30 714 685</p> 
2.0 T	07.01 -																							
2.3 T5	03.00 -																							
2.4	03.00 -																							
2.4 Bifuel	09.01 -																							
2.4 T	03.00 -																							
2.4 T AWD	09.01 -																							
2.5 T AWD	09.02 -																							
R 2,5 T AWD	03.03 -																							
2.4 D	12.01 -																							
2.4 D5, 120 kW	08.01 -																							
2.5 TDI	03.00 -																							
<p>Faltenbalgsatz, Lenkung / Bellow Kit, steering system</p> <p>Innendurchmesser 1 [mm] / Inner Diameter 1 [mm]:14 Innendurchmesser 2 [mm] / Inner Diameter 2 [mm]:50</p> <table border="1"> <tr><td>2.3 T5</td><td>03.00 -</td></tr> <tr><td>2.4</td><td>03.00 -</td></tr> <tr><td>2.4 Bifuel</td><td>09.01 -</td></tr> <tr><td>2.4 T</td><td>03.00 -</td></tr> <tr><td>2.4 T AWD</td><td>09.01 -</td></tr> <tr><td>2.4 D</td><td>12.01 -</td></tr> <tr><td>2.4 D5, 120 kW</td><td>08.01 -</td></tr> <tr><td>2.4 D5 AWD, 120 kW</td><td>03.03 -</td></tr> <tr><td>2.5 TDI</td><td>03.00 -</td></tr> </table>	2.3 T5	03.00 -	2.4	03.00 -	2.4 Bifuel	09.01 -	2.4 T	03.00 -	2.4 T AWD	09.01 -	2.4 D	12.01 -	2.4 D5, 120 kW	08.01 -	2.4 D5 AWD, 120 kW	03.03 -	2.5 TDI	03.00 -	<p></p>	<p>30249 272 418</p>				
2.3 T5	03.00 -																							
2.4	03.00 -																							
2.4 Bifuel	09.01 -																							
2.4 T	03.00 -																							
2.4 T AWD	09.01 -																							
2.4 D	12.01 -																							
2.4 D5, 120 kW	08.01 -																							
2.4 D5 AWD, 120 kW	03.03 -																							
2.5 TDI	03.00 -																							
<p> Lagerung, Lenker / Mounting, wishbone</p> <table border="1"> <tr><td>2.0 T</td><td>07.01 -</td></tr> <tr><td>2.3 T5</td><td>03.00 -</td></tr> <tr><td>2.4</td><td>03.00 -</td></tr> <tr><td>2.4 Bifuel</td><td>09.01 -</td></tr> <tr><td>2.4 T</td><td>03.00 -</td></tr> <tr><td>2.4 T AWD</td><td>09.01 -</td></tr> <tr><td>R 2,5 T AWD</td><td>03.03 -</td></tr> <tr><td>2.4 D</td><td>12.01 -</td></tr> <tr><td>2.4 D5, 120 kW</td><td>08.01 -</td></tr> <tr><td>2.5 TDI</td><td>03.00 -</td></tr> </table>	2.0 T	07.01 -	2.3 T5	03.00 -	2.4	03.00 -	2.4 Bifuel	09.01 -	2.4 T	03.00 -	2.4 T AWD	09.01 -	R 2,5 T AWD	03.03 -	2.4 D	12.01 -	2.4 D5, 120 kW	08.01 -	2.5 TDI	03.00 -	<p></p>	<p>26596 9 492 181</p> 		
2.0 T	07.01 -																							
2.3 T5	03.00 -																							
2.4	03.00 -																							
2.4 Bifuel	09.01 -																							
2.4 T	03.00 -																							
2.4 T AWD	09.01 -																							
R 2,5 T AWD	03.03 -																							
2.4 D	12.01 -																							
2.4 D5, 120 kW	08.01 -																							
2.5 TDI	03.00 -																							
<p>Lagerung, Lenker / Mounting, wishbone</p> <table border="1"> <tr><td>2.0 T</td><td>07.01 -</td></tr> <tr><td>2.3 T5</td><td>03.00 -</td></tr> <tr><td>2.4</td><td>03.00 -</td></tr> <tr><td>2.4 Bifuel</td><td>09.01 -</td></tr> <tr><td>2.4 T</td><td>03.00 -</td></tr> <tr><td>2.4 T AWD</td><td>09.01 -</td></tr> <tr><td>R 2,5 T AWD</td><td>03.03 -</td></tr> <tr><td>2.4 D</td><td>12.01 -</td></tr> <tr><td>2.4 D5, 120 kW</td><td>08.01 -</td></tr> <tr><td>2.5 TDI</td><td>03.00 -</td></tr> </table>	2.0 T	07.01 -	2.3 T5	03.00 -	2.4	03.00 -	2.4 Bifuel	09.01 -	2.4 T	03.00 -	2.4 T AWD	09.01 -	R 2,5 T AWD	03.03 -	2.4 D	12.01 -	2.4 D5, 120 kW	08.01 -	2.5 TDI	03.00 -	<p></p>	<p>26599 9 127 363</p> 		
2.0 T	07.01 -																							
2.3 T5	03.00 -																							
2.4	03.00 -																							
2.4 Bifuel	09.01 -																							
2.4 T	03.00 -																							
2.4 T AWD	09.01 -																							
R 2,5 T AWD	03.03 -																							
2.4 D	12.01 -																							
2.4 D5, 120 kW	08.01 -																							
2.5 TDI	03.00 -																							
<p>Stange/Strebe, Stabilisator / Rod/Strut, stabiliser</p> <p>Pendelstange / Suspension Rod</p> <table border="1"> <tr><td>2.0 T</td><td>07.01 -</td></tr> <tr><td>2.4</td><td>03.00 -</td></tr> <tr><td>2.4 Bifuel</td><td>09.01 -</td></tr> <tr><td>2.4 T</td><td>03.00 -</td></tr> <tr><td>2.4 T AWD</td><td>09.01 -</td></tr> <tr><td>2.5 T AWD</td><td>09.02 -</td></tr> <tr><td>R 2,5 T AWD</td><td>03.03 -</td></tr> <tr><td>2.4 D5, 120 kW</td><td>08.01 -</td></tr> <tr><td>2.4 D5 AWD, 120 kW</td><td>03.03 -</td></tr> <tr><td>2.5 TDI</td><td>03.00 -</td></tr> </table>	2.0 T	07.01 -	2.4	03.00 -	2.4 Bifuel	09.01 -	2.4 T	03.00 -	2.4 T AWD	09.01 -	2.5 T AWD	09.02 -	R 2,5 T AWD	03.03 -	2.4 D5, 120 kW	08.01 -	2.4 D5 AWD, 120 kW	03.03 -	2.5 TDI	03.00 -	<p></p>	<p>26793 30 714 678</p> 		
2.0 T	07.01 -																							
2.4	03.00 -																							
2.4 Bifuel	09.01 -																							
2.4 T	03.00 -																							
2.4 T AWD	09.01 -																							
2.5 T AWD	09.02 -																							
R 2,5 T AWD	03.03 -																							
2.4 D5, 120 kW	08.01 -																							
2.4 D5 AWD, 120 kW	03.03 -																							
2.5 TDI	03.00 -																							









OE

VOLVO

V70 II Kombi/Estate/Break



03.00 -

<p> Achskörperlager / Mounting, axle body</p> <p>2.0 T 07.01 - 2.3 T5 03.00 - 2.4 03.00 - 2.4 Bifuel 09.01 - 2.4 T 03.00 - 2.4 D 12.01 - 2.4 D5, 120 kW 08.01 - 2.5 TDI 03.00 -</p>	<p>↔</p>	<p>26815 3 516 122</p> 
<p>Achskörperlager / Mounting, axle body</p> <p>ALL TYPES ausser/except for : 2.4 D5, 136 kW 12.05 - 2.4 D5 AWD, 136 kW 12.05 -</p>	<p>▲ ↔ ↑</p>	<p>29505 9 169 204</p> 
<p>Achskörperlager / Mounting, axle body</p> <p>ALL TYPES ausser/except for : 2.4 D5, 136 kW 12.05 - 2.4 D5 AWD, 136 kW 12.05 -</p>	<p>▲ ↔ ↓</p>	<p>29508 9 465 975</p> 
<p>Achskörperlager / Mounting, axle body</p> <p>ALL TYPES ausser/except for : 2.4 D5, 136 kW 12.05 - 2.4 D5 AWD, 136 kW 12.05 -</p>	<p>▲ ↔ ↓</p>	<p>29509 9 173 761</p> 
<p>Achskörperlager / Mounting, axle body</p> <p>ALL TYPES ausser/except for : 2.4 D5, 136 kW 12.05 - 2.4 D5 AWD, 136 kW 12.05 -</p>	<p>▽ ↔ ↻</p>	<p>29510 30 645 401</p> 

V90 Kombi/Estate/Break

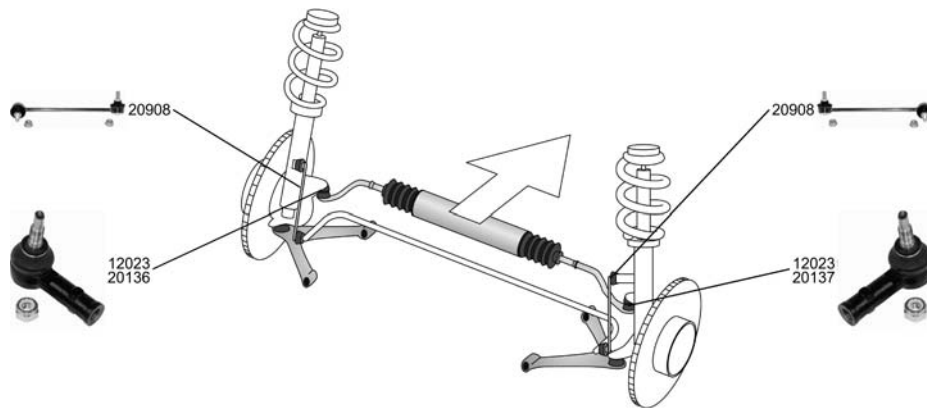
01.97 - 12.98















<p>Spurstangenkopf / Tie-rod End Konusmaß [mm] / Cone Size [mm]:14 Gewindeart: mit Rechtsgewinde / Thread Type: with right-hand thread Innengewinde [mm] / Inner Thread [mm]:M14x2 Gewindemaß / Thread Size:M14x2 für Lenkgetriebe-ID / For steering rack ID:ZF/CAM/TRW</p> <p>ALL TYPES</p>	<p>↔ ↻</p>	<p>12023 3 516 944</p> 
<p>Spurstangenkopf / Tie-rod End mit Zubehör / With accessories</p> <p>ALL TYPES</p>	<p>↻ ↻</p>	<p>20136 271 598</p> 



VOLVO

V90 Kombi/Estate/Break





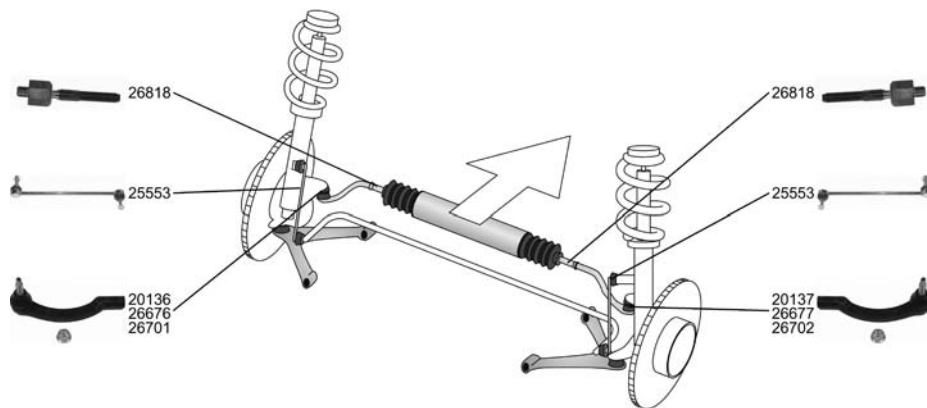

01.97 - 12.98

 Spurstangenkopf / Tie-rod End mit Zubehör / With accessories ALL TYPES		20137 271 599 
Axialgelenk, Spurstange / Axial Rod, tie rod Achsausführung / Axle Version:CAM Gewindemaß / Thread Size:M14x2 Gewindeart: mit Rechtsgewinde / Thread Type: with right-hand thread ALL TYPES		20133 9 140 504 
Lagerung, Lenker / Mounting, wishbone ALL TYPES		25996 6 819 537 
Lagerung, Lenker / Mounting, wishbone ALL TYPES		29543 9 191 537 
Stange/Strebe, Stabilisator / Rod/Strut, stabiliser Pendelstange / Suspension Rod ALL TYPES		20908 272 991 
Faltenbalgsatz, Lenkung / Bellow Kit, steering system ALL TYPES		30233 9 191 409
Faltenbalgsatz, Lenkung / Bellow Kit, steering system ALL TYPES	 für / for:TRW	30242 271 601

XC70 CROSS COUNTRY

03.00 -



Spurstangenkopf / Tie-rod End mit Zubehör / With accessories 2.4 T XC AWD 03.00 - 09.02		20136 271 598 
Spurstangenkopf / Tie-rod End mit Zubehör / With accessories 2.4 T XC AWD 03.00 - 09.02		20137 271 599 
Spurstangenkopf / Tie-rod End mit Zubehör / With accessories 2.5 T XC AWD 09.02 - 2.4 D5 XC AWD 09.02 -	 für / for:ZF 01.2004->	26676 274 496 























OE

VOLVO

XC70 CROSS COUNTRY

03.00 -

	Spurstangenkopf / Tie-rod End mit Zubehör / With accessories			26677 274 497	
	2.5 T XC AWD 09.02 - 2.4 D5 XC AWD 09.02 -	für / for:ZF 01.2004->			
	Spurstangenkopf / Tie-rod End Konusmaß [mm] / Cone Size [mm]:9,53 mit Zubehör / With accessories			26701 30 776 806	
2.4 T XC AWD 03.00 - 09.02 2.5 T XC AWD 09.02 - 2.4 D5 XC AWD 09.02 -	für / for:SMI für / for:SMI ->12.2003				
	Spurstangenkopf / Tie-rod End Konusmaß [mm] / Cone Size [mm]:9,53 mit Zubehör / With accessories			26702 30 760 807	
2.4 T XC AWD 03.00 - 09.02 2.5 T XC AWD 09.02 - 2.4 D5 XC AWD 09.02 -	für / for:SMI für / for:SMI ->12.2003				
	Axialgelenk, Spurstange / Axial Rod, tie rod			26818 274 353	
2.5 T XC AWD 09.02 - 2.4 D5 XC AWD 09.02 -	für / for:ZF 01.2004->				
	Lagerung, Lenker / Mounting, wishbone			26600 9 443 882	
2.4 T XC AWD 03.00 - 09.02 2.5 T XC AWD 09.02 - 2.4 D5 XC AWD 09.02 -					
	Stange/Strebe, Stabilisator / Rod/Strut, stabiliser Pendelstange / Suspension Rod mit Zubehör / With accessories Gewindeart: mit Rechtsgewinde / Thread Type: with right-hand thread Gewindemaß / Thread Size:M10 Gewindemaß / Thread Size:M12			25553 30 714 685	
2.4 T XC AWD 03.00 - 09.02 2.5 T XC AWD 09.02 - 2.4 D5 XC AWD 09.02 -					
	Faltenbalgsatz, Lenkung / Bellow Kit, steering system			30242 271 601	
2.4 T XC AWD 03.00 - 09.02	für / for:TRW				
	Faltenbalgsatz, Lenkung / Bellow Kit, steering system Innendurchmesser 1 [mm] / Inner Diameter 1 [mm]:14 Innendurchmesser 2 [mm] / Inner Diameter 2 [mm]:50			30249 272 418	
2.5 T XC AWD 09.02 - 2.4 D5 XC AWD 09.02 -					
	Stange/Strebe, Stabilisator / Rod/Strut, stabiliser Pendelstange / Suspension Rod			26793 30 714 678	
	2.4 T XC AWD 03.00 - 09.02 2.5 T XC AWD 09.02 - 2.4 D5 XC AWD 09.02 -				
	Achskörperlager / Mounting, axle body			26597 9 200 154	
2.4 T XC AWD 03.00 - 09.02 2.5 T XC AWD 09.02 - 2.4 D5 XC AWD 09.02 -					









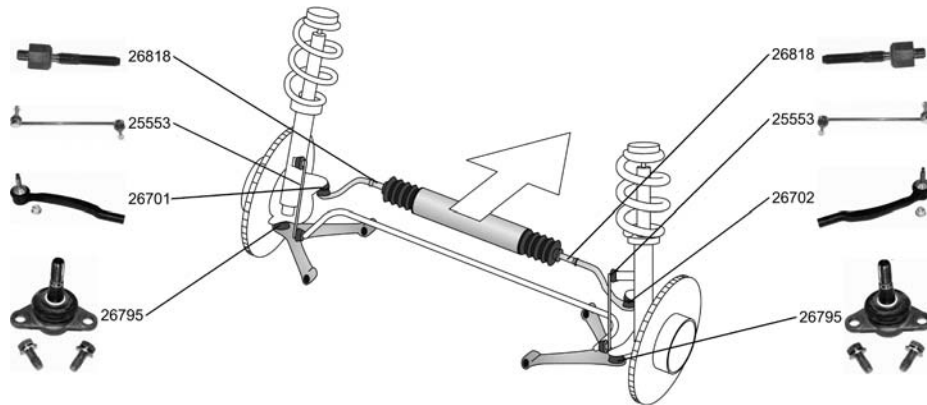

































VOLVO

XC 90

10.02 -

















Spurstangenkopf / Tie-rod End Konusmaß [mm] / Cone Size [mm]:9,53 mit Zubehör / With accessories ALL TYPES		↻	26701 30 776 806 
Spurstangenkopf / Tie-rod End Konusmaß [mm] / Cone Size [mm]:9,53 mit Zubehör / With accessories ALL TYPES		↻	26702 30 760 807 
Axialgelenk, Spurstange / Axial Rod, tie rod ALL TYPES		↻ ↺	26818 274 353 
Trag-/Führungsgelenk / Support-/ Steering Link mit Zubehör / With accessories 2.5 T 10.02 - T6 10.02 - D5 10.02 -		↻	26795 274 573 
Stange/Strebe, Stabilisator / Rod/Strut, stabiliser Pendelstange / Suspension Rod mit Zubehör / With accessories Gewindeart: mit Rechtsgewinde / Thread Type: with right-hand thread Gewindemaß / Thread Size:M10 Gewindemaß / Thread Size:M12 2.5 T 10.02 - T6 10.02 - D5 10.02 -		↻	25553 30 714 685 
 Achskörperlager / Mounting, axle body 2.5 T 10.02 - T6 10.02 - D5 10.02 -		↻	26597 9 200 154 

Artikelnummer Article No.	Seite Page	Hersteller Manufacturer	Artikelnummer Article No.	Seite Page	Hersteller Manufacturer
11756 	3 7	VOLVO	12024 	2 6	VOLVO
Lagerung, Lenker / Mounting, wishbone			Axialgelenk, Spurstange / Axial Rod, tie rod		
11843 	34 44	VOLVO	12025 	9 10	VOLVO
Spurstangenkopf / Tie-rod End			Axialgelenk, Spurstange / Axial Rod, tie rod		
12001 	1 5	VOLVO	12031 	19 21	VOLVO
Axialgelenk, Spurstange / Axial Rod, tie rod			Trag-/Führungsgelenk / Support-/ Steering Link		
12002 	1 5	VOLVO	12032 	3 7	VOLVO
Axialgelenk, Spurstange / Axial Rod, tie rod			Lagerung, Lenker / Mounting, wishbone		
12004 	2 6	VOLVO	12037 	12 14 16 18 22 23 24 26 27 28	VOLVO
Lenker, Radaufhängung / Track Control Arm			Lagerung, Lenker / Mounting, wishbone		
12007 	2 5	VOLVO	15560 	34 44	VOLVO
Axialgelenk, Spurstange / Axial Rod, tie rod			Spurstangenkopf / Tie-rod End		
12008 	11 14 15 17	VOLVO	19279 	2 6	VOLVO
Axialgelenk, Spurstange / Axial Rod, tie rod			Axialgelenk, Spurstange / Axial Rod, tie rod		
12011 	11 13 15 17 21 23 24 25 26 28	VOLVO	20120 	13 15 16 18 22 24 25 26 27 28 29 31	VOLVO
Spurstange / Tie Rod, steering			Stabilisatorlager / Mounting, Stabilizer		
12012 	12 14 16 17 18 22 23 24 26 27 28 29 30	VOLVO	20123 	13 15 22 23 25 26 27 28 29 30	VOLVO
Trag-/Führungsgelenk / Support-/ Steering Link			Lagerung, Lenker / Mounting, wishbone		
12014 	3 6	VOLVO	20128 	12 14 16 18 22 23 25 26	VOLVO
Trag-/Führungsgelenk / Support-/ Steering Link			Achsstrebenlager / Mounting, axle strut		
12015 	3 6	VOLVO	20130 	4 8 13 15 16 18 22 24 25 26 27 28 30 31	VOLVO
Trag-/Führungsgelenk / Support-/ Steering Link			Lagerung, Panhardstab / Suspension, panhard rod		
12016 	3 7	VOLVO	20133 	12 14 16 17 22 23 24 25 27 28 29 30 43 52	VOLVO
Trag-/Führungsgelenk / Support-/ Steering Link			Axialgelenk, Spurstange / Axial Rod, tie rod		
12017 	8 9	VOLVO	20136 	19 20 31 32 39 43 47 51 52	VOLVO
Trag-/Führungsgelenk / Support-/ Steering Link			Spurstangenkopf / Tie-rod End		
12018 	8	VOLVO	20137 	19 20 31 32 39 43 47 52	VOLVO
Axialgelenk, Spurstange / Axial Rod, tie rod			Spurstangenkopf / Tie-rod End		
12019 	9 10	VOLVO	20143 	8	VOLVO
Spurstangenkopf / Tie-rod End			Spurstangenkopf / Tie-rod End		
12020 	9 10	VOLVO	20144 	8 9	VOLVO
Trag-/Führungsgelenk / Support-/ Steering Link			Axialgelenk, Spurstange / Axial Rod, tie rod		
12023 	1 4 11 13 15 17 18 21 23 24 25 27 28 29 30 43 51	VOLVO	20172 	19 20 31 33 39 47	VOLVO
Spurstangenkopf / Tie-rod End			Axialgelenk, Spurstange / Axial Rod, tie rod		

Arithmetische Liste / Part number list

Artikelnummer Article No.	Seite Page	Hersteller Manufacturer	Artikelnummer Article No.	Seite Page	Hersteller Manufacturer
20382	3 7	VOLVO	26600 ⓈⓂ	37 41 50	VOLVO
Lenkwelle / Steering Shaft			Lagerung, Lenker / Mounting, wishbone	53	
20908 Ⓢ	29 30 43	VOLVO	26674 Ⓢ♂	40	VOLVO
Stange/Strebe, Stabilisator / Rod/Strut, stabiliser	52		Spurstangenkopf / Tie-rod End		
21678 Ⓢ	20 21 32	VOLVO	26675 Ⓢ♂	41	VOLVO
Stange/Strebe, Stabilisator / Rod/Strut, stabiliser	33 40 48		Spurstangenkopf / Tie-rod End		
22652 ▽Ⓢ	19 21 32	VOLVO	26676 Ⓢ♂	37 41 49	VOLVO
Lagerung, Lenker / Mounting, wishbone	33 39 48		Spurstangenkopf / Tie-rod End	52	
24602 ▽Ⓢ	17 19 20	VOLVO	26677 Ⓢ♂	37 41 49	VOLVO
Lenker, Radaufhängung / Track Control Arm	39 47		Spurstangenkopf / Tie-rod End	53	
24603 ▽Ⓢ	17 19 20	VOLVO	26701 Ⓢ	53 54	VOLVO
Lenker, Radaufhängung / Track Control Arm	39 47		Spurstangenkopf / Tie-rod End		
24604 ▽Ⓢ	19 20 39	VOLVO	26702 Ⓢ	53 54	VOLVO
Lenker, Radaufhängung / Track Control Arm	48		Spurstangenkopf / Tie-rod End		
24605 ▽Ⓢ	19 21 39	VOLVO	26793 Ⓢ	38 40 42	VOLVO
Lenker, Radaufhängung / Track Control Arm	48		Stange/Strebe, Stabilisator / Rod/Strut, stabiliser	49 50 53	
24606 ▽Ⓢ	31 33	VOLVO	26795 Ⓢ	54	VOLVO
Lenker, Radaufhängung / Track Control Arm			Trag-/Führungsgelenk / Support-/ Steering Link		
24607 ▽Ⓢ	31 33	VOLVO	26815 Ⓢ	20 21 32	VOLVO
Lenker, Radaufhängung / Track Control Arm			Achskörperlager / Mounting, axle body	33 40 49	
25487 Ⓢ	35 45	VOLVO	26818 Ⓢ♂	37 41 49	VOLVO
Axialgelenk, Spurstange / Axial Rod, tie rod			Axialgelenk, Spurstange / Axial Rod, tie rod	53 54	
25550 ▽Ⓢ♂	31 37 41	VOLVO	27612 Ⓢ♂△	34 45	VOLVO
Trag-/Führungsgelenk / Support-/ Steering Link			Spurstangenkopf / Tie-rod End		
25553 Ⓢ	37 42 50	VOLVO	27613 Ⓢ♂△	35 45	VOLVO
Stange/Strebe, Stabilisator / Rod/Strut, stabiliser	53 54		Spurstangenkopf / Tie-rod End		
25996 ▽ⓈⓂ	29 30 43	VOLVO	27705 ▽Ⓢ♂	32 33 40	VOLVO
Lagerung, Lenker / Mounting, wishbone	52		Lagerung, Lenker / Mounting, wishbone	48	
25997 ⓈⓂ	35 45	VOLVO	27706 ▽Ⓢ♂	32 33 40	VOLVO
Lagerung, Lenker / Mounting, wishbone			Lagerung, Lenker / Mounting, wishbone	48	
26588 Ⓢ	35 46	VOLVO	29499 Ⓢ	36 47	VOLVO
Lagerung, Lenker / Mounting, wishbone			Stange/Strebe, Stabilisator / Rod/Strut, stabiliser		
26596 ▽Ⓢ	38 42 50	VOLVO	29505 △ⓈⓂ	38 42 51	VOLVO
Lagerung, Lenker / Mounting, wishbone			Achskörperlager / Mounting, axle body		
26597 Ⓢ	53 54	VOLVO	29506 △ⓈⓂ	38	VOLVO
Achskörperlager / Mounting, axle body			Achskörperlager / Mounting, axle body		
26599 Ⓢ♂	38 42 50	VOLVO	29507 ▽ⓈⓂ	38	VOLVO
Lagerung, Lenker / Mounting, wishbone			Achskörperlager / Mounting, axle body		
			29508 △ⓈⓂ	38 42 51	VOLVO
			Achskörperlager / Mounting, axle body		
			29509 △ⓈⓂ	38 42 51	VOLVO
			Achskörperlager / Mounting, axle body		

Artikelnummer Article No.	Seite Page	Hersteller Manufacturer	Artikelnummer Article No.	Seite Page	Hersteller Manufacturer
29510 	38 43 51	VOLVO			
Achskörperlager / Mounting, axle body					
29543 	29 30 43	VOLVO			
Lagerung, Lenker / Mounting, wishbone	52				
29640 	36 46	VOLVO			
Stange/Strebe, Stabilisator / Rod/Strut, stabiliser					
29794 	36 47	VOLVO			
Achskörperlager / Mounting, axle body					
30185 	3 7 13	VOLVO			
Faltenbalgsatz, Lenkung / Bellow Kit, steering system	14 16 18				
30186 	3 7 13	VOLVO			
Faltenbalgsatz, Lenkung / Bellow Kit, steering system	14 16 18				
30187 	9	VOLVO			
Faltenbalgsatz, Lenkung / Bellow Kit, steering system					
30220 	36 46	VOLVO			
Faltenbalgsatz, Lenkung / Bellow Kit, steering system					
30233 	32 33 40	VOLVO			
Faltenbalgsatz, Lenkung / Bellow Kit, steering system	42 43 48 52				
30242 	32 33 40	VOLVO			
Faltenbalgsatz, Lenkung / Bellow Kit, steering system	44 48 52 53				
30249	37 42 50	VOLVO			
Faltenbalgsatz, Lenkung / Bellow Kit, steering system	53				
30339 	41	VOLVO			
Lagerung, Lenker / Mounting, wishbone					
30461 	36 46	VOLVO			
Reparatursatz, Trag- /Führungsgelenk Repair Kit, support/ steering link					
30462 	36 46	VOLVO			
Spurstangenkopf / Tie-rod End					
30463 	36 46	VOLVO			
Spurstangenkopf / Tie-rod End					

Vergleichsliste / Cross reference list

Vergleichs-Nr. Compare No.	Artikelnummer Article No.	Vergleichs-Nr. Compare No.	Artikelnummer Article No.	Vergleichs-Nr. Compare No.	Artikelnummer Article No.
VOLVO		VOLVO			
1 205 659	12001	8 623 576	29499		
1 205 825	12032	8 628 495	24605		
1 229 608	20120	8 628 496	24604		
1 272 306	20123	8 628 497	24603		
1 272 924	30186	8 628 498	24602		
1 272 925	30185	8 628 499	24607		
1 272 947	12007	8 628 500	24606		
1 273 778	11756	9 127 363	26599		
1 329 655	20128	9 140 504	20133		
1 330 973	20130	9 140 505	19279		
1 359 347	12008	9 157 572	29506		
1 359 599	12037	9 157 576	29507		
270 477	12012	9 169 204	29505		
271 389	12011	9 173 761	29509		
271 591	12031	9 181 013	27705		
271 598	20136	9 181 027	27706		
271 599	20137	9 191 409	30233		
271 601	30242	9 191 537	29543		
271 631	22652	9 200 154	26597		
272 416	26674	9 443 882	26600		
272 417	26675	9 465 971	30339		
272 418	30249	9 465 975	29508		
272 991	20908	9 492 181	26596		
274 117	12014				
274 118	12015				
274 119	12016				
274 225	27612				
274 226	27613				
274 353	26818				
274 496	26676				
274 497	26677				
274 500	30462				
274 501	30463				
274 548	25550				
274 573	26795				
3 211 955	20143				
3 211 956	12017				
3 268 829	20144				
3 293 736	12018				
3 343 641	30187				
3 345 796	30220				
3 345 797	25487				
3 410 369	12025				
3 465 482	12020				
3 480 012	12019				
3 516 122	26815				
3 516 944	12023				
3 530 167	12024				
3 546 266	20172				
30 645 401	29510				
30 666 821	29794				
30 714 678	26793				
30 714 685	25553				
30 714 686	21678				
30 760 807	26702				
30 776 806	26701				
30 818 467	25997				
30 875 012	11843				
30 884 358	29640				
30 887 024	26588				
6 819 537	25996				

Neuaufnahmen / New to range

Artikelnummer Article No.	Seite Page	Hersteller Manufacturer
11756	3 7	VOLVO
12004	2 6	VOLVO
12008	11 14 15 17	VOLVO
12024	2 6	VOLVO
12032	3 7	VOLVO
12037	12 14 16 18 22 23 24 26 27 28	VOLVO
19279	2 6	VOLVO
20120	13 15 16 18 22 24 25 26 27 28 29 31	VOLVO
20123	13 15 22 23 25 26 27 28 29 30	VOLVO
20128	12 14 16 18 22 23 25 26	VOLVO
20130	4 8 13 15 16 18 22 24 25 26 27 28 30 31	VOLVO
20133	12 14 16 17 22 23 24 25 27 28 29 30 43 52	VOLVO
20136	19 20 31 32 39 43 47 51 52	VOLVO
20137	19 20 31 32 39 43 47 52	VOLVO
20172	19 20 31 33 39 47	VOLVO
21678	20 21 32 33 40 48	VOLVO
22652	19 21 32 33 39 48	VOLVO
24602	17 19 20 39 47	VOLVO
24603	17 19 20 39 47	VOLVO
24604	19 20 39 48	VOLVO
24605	19 21 39 48	VOLVO
24606	31 33	VOLVO
24607	31 33	VOLVO
25550	31 37 41	VOLVO
25553	37 42 50 53 54	VOLVO
25996	29 30 43 52	VOLVO
25997	35 45	VOLVO
26588	35 46	VOLVO
26596	38 42 50	VOLVO
26597	53 54	VOLVO

Artikelnummer Article No.	Seite Page	Hersteller Manufacturer
26599	38 42 50	VOLVO
26600	37 41 50 53	VOLVO
26674	40	VOLVO
26675	41	VOLVO
26676	37 41 49 52	VOLVO
26677	37 41 49 53	VOLVO
26701	53 54	VOLVO
26702	53 54	VOLVO
26793	38 40 42 49 50 53	VOLVO
26795	54	VOLVO
26815	20 21 32 33 40 49 51	VOLVO
26818	37 41 49 53 54	VOLVO
27612	34 45	VOLVO
27613	35 45	VOLVO
27705	32 33 40 48	VOLVO
27706	32 33 40 48	VOLVO
29499	36 47	VOLVO
29505	38 42 51	VOLVO
29506	38	VOLVO
29507	38	VOLVO
29508	38 42 51	VOLVO
29509	38 42 51	VOLVO
29510	38 43 51	VOLVO
29543	29 30 43 52	VOLVO
29640	36 46	VOLVO
29794	36 47	VOLVO
30185	3 7 13 14 16 18	VOLVO
30186	3 7 13 14 16 18	VOLVO
30187	9	VOLVO
30220	36 46	VOLVO
30233	32 33 40 42 43 48 52	VOLVO
30242	32 33 40 44 48 52 53	VOLVO
30249	37 42 50 53	VOLVO
30339	41	VOLVO
30461	36 46	VOLVO
30462	36 46	VOLVO
30463	36 46	VOLVO

Geänderte Bestellnummer / Amended part numbers

Artikelnummer alt Article No. old	Artikelnummer neu Article No. new	Artikelnummer alt Article No. old	Artikelnummer neu Article No. new	Artikelnummer alt Article No. old	Artikelnummer neu Article No. new
025 160 051 622	12011				
11843	15560				
14951	11843				
20169	21678				
26794	26793				
28274	29640				

Geänderte Bestellnummer / Amended part numbers

Artikelnummer neu Article No. new	Artikelnummer alt Article No. old	Artikelnummer neu Article No. new	Artikelnummer alt Article No. old	Artikelnummer neu Article No. new	Artikelnummer alt Article No. old
11843	14951				
12011	025 160 051 622				
15560	11843				
21678	20169				
26793	26794				
29640	28274				

© ZF Trading GmbH - 14.10.06