











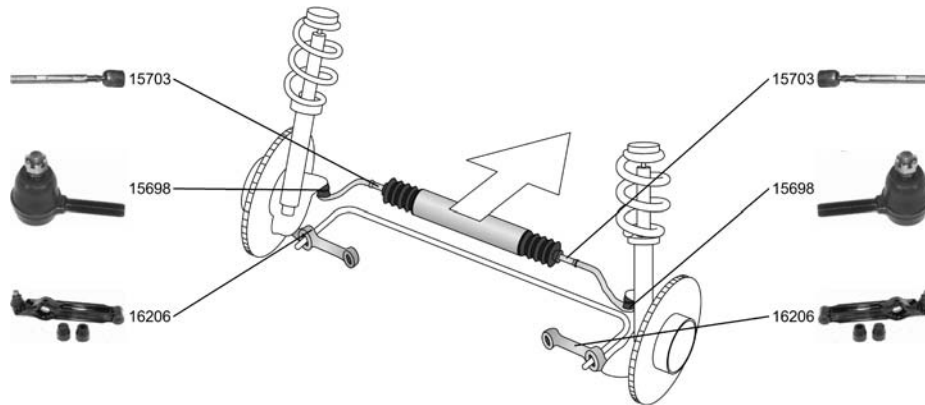

OE

**SUZUKI**

**ALTO II (EC)**

**01.86 - 11.93**





<p><b>Spurstangenkopf / Tie-rod End</b>                  Gewindeart: mit Rechtsgewinde / Thread Type: with right-hand thread                  Gewindemaß / Thread Size:M12x1,25                  Aussengewinde [mm] / Outer Thread [mm]:M12x1,25                  ALL TYPES</p>		<p><b>15698</b>      48810-84000</p> 
<p><b>Axialgelenk, Spurstange / Axial Rod, tie rod</b>                  Gewindeart: mit Rechtsgewinde / Thread Type: with right-hand thread                  Gewindemaß / Thread Size:M12x1,25                  ALL TYPES</p>		<p><b>15703</b>      48830-84000</p> 
<p><b>Lenker, Radaufhängung / Track Control Arm</b>                  ALL TYPES</p>		<p><b>16206</b>      45200-84000</p> 
<p><b>Faltenbalsatz, Lenkung / Bellow Kit, steering system</b>                  ALL TYPES</p>		<p><b>30156</b>      48572-82000</p> 
		

**ALTO III (EF)**

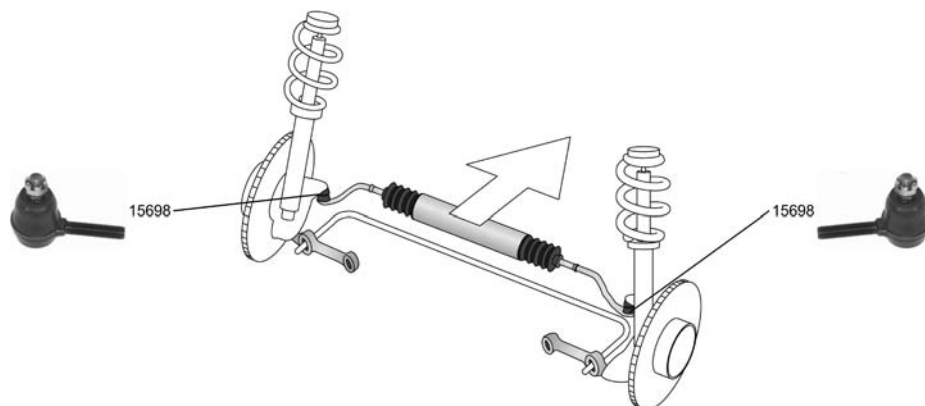
**09.94 - 06.02**



<p><b>Spurstangenkopf / Tie-rod End</b>                  Gewindeart: mit Rechtsgewinde / Thread Type: with right-hand thread                  Gewindemaß / Thread Size:M12x1,25                  Aussengewinde [mm] / Outer Thread [mm]:M12x1,25                  1.0, 39 kW</p>		<p><b>15698</b>      48810-84000</p> 
<p>09.94 - 06.02</p>		







OE

## SUZUKI

ALTO III (EF)



09.94 - 06.02

 <b>Faltenbalgsatz, Lenkung / Bellow Kit, steering system</b> 1.0, 39 kW		<b>30156</b> 48572-82000 
	09.94 - 06.02 	

BALENO (EG)

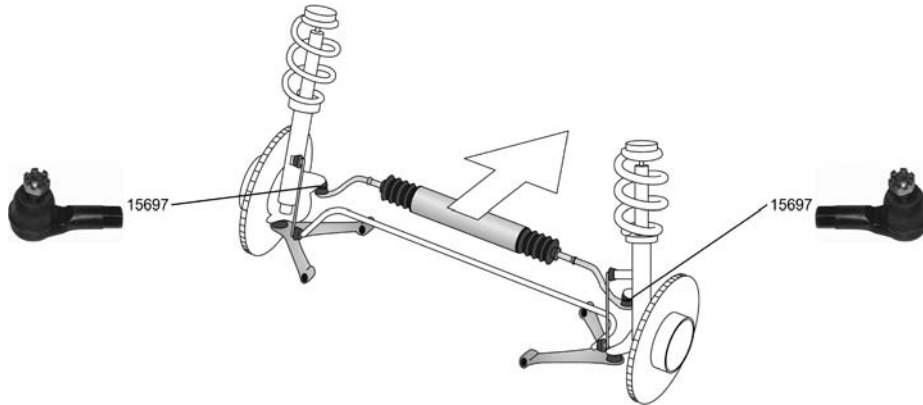
07.95 -





<b>Spurstangenkopf / Tie-rod End</b> Gewindeart: mit Rechtsgewinde / Thread Type: with right-hand thread Gewindemaß / Thread Size:M12x1,25 Innengewinde [mm] / Inner Thread [mm]:M12x1,25	 	<b>15697</b> 48810-82000 
ALL TYPES ausser/except for : 1.5 (SY415)      01.95 - 1.5 (GC21)      07.95 -		

BALENO Kombi/Estate/Break (EG)

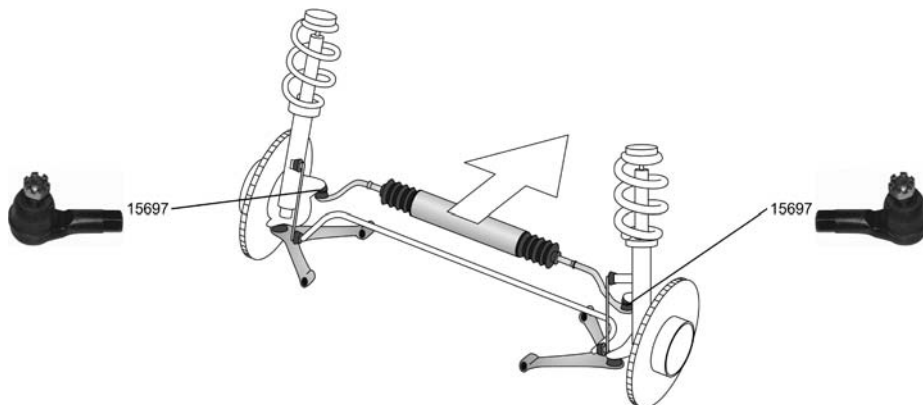
08.96 -





<b>Spurstangenkopf / Tie-rod End</b> Gewindeart: mit Rechtsgewinde / Thread Type: with right-hand thread Gewindemaß / Thread Size:M12x1,25 Innengewinde [mm] / Inner Thread [mm]:M12x1,25	 	<b>15697</b> 48810-82000 
ALL TYPES		



OE



**SUZUKI**

**BALENO** 07.95 -  
Schrägheck/Hatchback/avec hayon  
(EG)

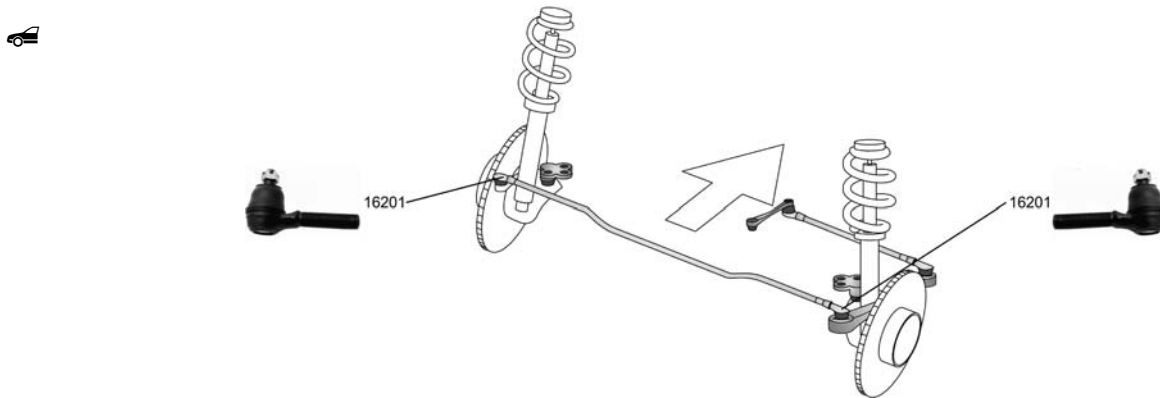

 <b>Spurstangenkopf / Tie-rod End</b> Gewindeart: mit Rechtsgewinde / Thread Type: with right-hand thread Gewindemaß / Thread Size:M12x1,25 Innengewinde [mm] / Inner Thread [mm]:M12x1,25 ALL TYPES		<b>15697</b> 48810-82000 
---	---	---

**SAMURAI (SJ)** 11.88 -





<b>Spurstangenkopf / Tie-rod End</b> Gewindeart: mit Rechtsgewinde / Thread Type: with right-hand thread Gewindemaß / Thread Size:M16x1,5 1.0 (SJ 410) 11.88 - 1.3 (SJ 413) 11.88 - .		<b>16201</b> 48810-83300 
---	---	---



**SJ 410** 09.81 - 12.88

 <b>Spurstangenkopf / Tie-rod End</b> Gewindeart: mit Rechtsgewinde / Thread Type: with right-hand thread Gewindemaß / Thread Size:M16x1,5 ALL TYPES		<b>16201</b> 48810-83300 
--	---	---

**SJ 410 Cabrio/open off-road vehicle/carrosserie ouverte** 09.81 - 12.88

 <b>Spurstangenkopf / Tie-rod End</b> Gewindeart: mit Rechtsgewinde / Thread Type: with right-hand thread Gewindemaß / Thread Size:M16x1,5 ALL TYPES		<b>16201</b> 48810-83300 
--	---	---

**SJ 413** 09.84 - 08.90

 <b>Spurstangenkopf / Tie-rod End</b> Gewindeart: mit Rechtsgewinde / Thread Type: with right-hand thread Gewindemaß / Thread Size:M16x1,5 ALL TYPES		<b>16201</b> 48810-83300 
--	---	---



## SUZUKI

SUPER CARRY Bus/Familial (ED)

10.85 - 03.99

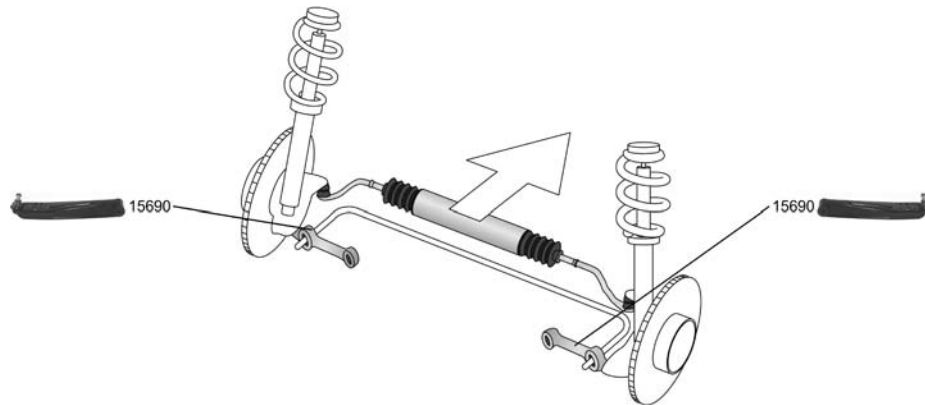



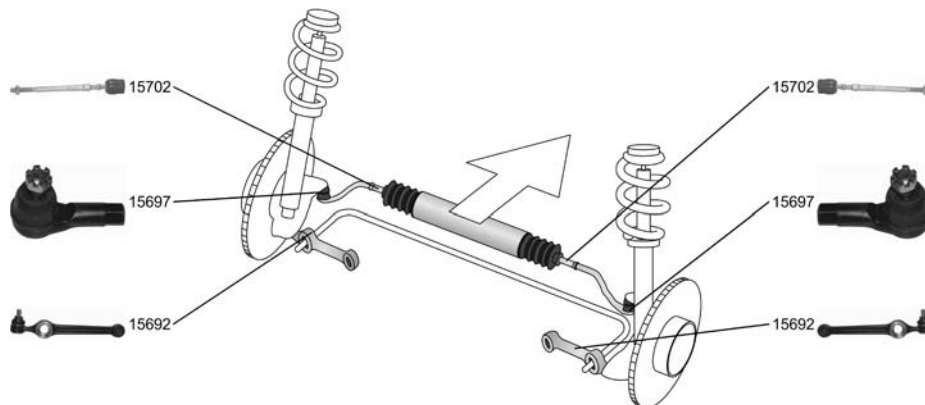

<b>Lenker, Radaufhängung / Track Control Arm</b>		▼↔	<b>15690</b>	<b>45200-77500</b>
1.0, 30 kW	09.94 - 03.99			
1.0, 31 kW	10.92 - 03.99			
1.0, 33 kW	10.85 - 03.99	10.1991->		

## SWIFT I (AA)

10.83 - 12.89



<b>Spurstangenkopf / Tie-rod End</b> Gewindart: mit Rechtsgewinde / Thread Type: with right-hand thread Gewindemaß / Thread Size:M12x1,25 Innengewinde [mm] / Inner Thread [mm]:M12x1,25 ALL TYPES		↔↻	<b>15697</b>	<b>48810-82000</b>
				
<b>Axialgelenk, Spurstange / Axial Rod, tie rod</b> Gewindart: mit Rechtsgewinde / Thread Type: with right-hand thread Gewindemaß / Thread Size:M12x1,25 ALL TYPES		↔↻	<b>15702</b>	<b>48830-82000</b>
				
<b>Lenker, Radaufhängung / Track Control Arm</b> ALL TYPES		▼↔	<b>15692</b>	<b>45200-82000</b>
		->08.1988		
<b>Faltenbalgsatz, Lenkung / Bellow Kit, steering system</b> ALL TYPES		↔↻	<b>30156</b>	<b>48572-82000</b>
		↻		











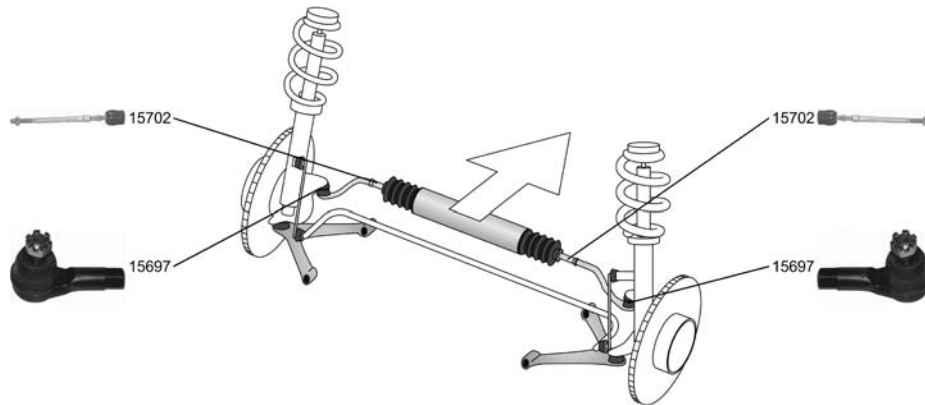

OE

**SUZUKI**

**SWIFT II (AH, AJ)**

**03.89 - 05.01**









<p><b>Spurstangenkopf / Tie-rod End</b>                  Gewindeart: mit Rechtsgewinde / Thread Type: with right-hand thread                  Gewindemaß / Thread Size:M12x1,25                  Innengewinde [mm] / Inner Thread [mm]:M12x1,25                  ALL TYPES</p>		<p><b>15697</b> 48810-82000</p> 
<p><b>Axialgelenk, Spurstange / Axial Rod, tie rod</b>                  Gewindeart: mit Rechtsgewinde / Thread Type: with right-hand thread                  Gewindemaß / Thread Size:M12x1,25                  ALL TYPES</p>		<p><b>15702</b> 48830-82000</p> 
<p><b>Faltenbalgsatz, Lenkung / Bellow Kit, steering system</b>                  1.3 (SF413, AH35, MA) 03.89 - 05.01</p> <p>1.3 (SF413, AH35) 03.89 - 12.91                  1.6 i (SF416, AH14) 01.90 - 05.01                  1.6 i 4WD (SF416, AJ14) 01.90 - 05.01                  1.6 (SF416, AH14) 11.89 - 12.91                  1.6 4WD (SF416, AJ14) 11.89 - 12.91</p>	  ->10.1996 	<p><b>30156</b> 48572-82000</p> 
<p><b>Faltenbalgsatz, Lenkung / Bellow Kit, steering system</b>                  1.3 (SF413, AH35, MA) 03.89 - 05.01</p>	 11.1996->	<p><b>30229</b> B2113-2125</p> 

**SWIFT II**

**03.89 - 05.01**

**Schrägheck/Hatchback/avec hayon (EA)**





<p><b>Spurstangenkopf / Tie-rod End</b>                  Gewindeart: mit Rechtsgewinde / Thread Type: with right-hand thread                  Gewindemaß / Thread Size:M12x1,25                  Innengewinde [mm] / Inner Thread [mm]:M12x1,25</p> <p>1.0 (SF310, AA44) 03.89 - 05.01                  1.0 i (SF310, AA44) 03.89 - 05.01                  1.3 (SF413, AB35) 03.89 - 05.01                  1.3 4WD (SF413, AA35) 03.89 - 05.01                  1.3 4WD (SF413, AF35) 10.89 - 12.91                  1.3 GTi (SF413, AA34) 03.89 - 05.01</p>		<p><b>15697</b> 48810-82000</p> 
<p><b>Faltenbalgsatz, Lenkung / Bellow Kit, steering system</b></p> <p>1.0 (SF310, AA44) 03.89 - 05.01                  1.0 i (SF310, AA44), 39 kW 09.91 - 05.01                  1.3 4WD (SF413, AA35) 03.89 - 05.01                  1.3 GTi (SF413, AA34) 03.89 - 05.01</p> <p>1.0 i (SF310, AA44), 40 kW 03.89 - 12.91                  1.3 (SF413, AB35), 52 kW 03.89 - 12.91                  1.3 4WD (SF413, AF35) 10.89 - 12.91                  1.3 (SF413, AB35), 50 kW 03.89 - 05.01</p>	  ->10.1996   zum Zylinder 1 / to cylinder 1	<p><b>30156</b> 48572-82000</p> 



# SUZUKI

**SWIFT II**  
**Schrägheck/Hatchback/avec hayon**  
**(EA)**





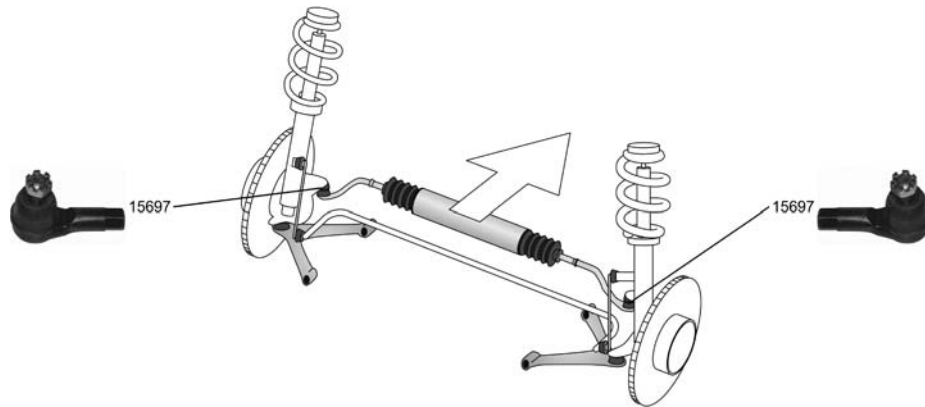

**03.89 - 05.01**

	<b>Faltenbalsatz, Lenkung / Bellow Kit, steering system</b>		<b>30229</b>	<b>B2113-2125</b>
	1.0 (SF310, AA44) 03.89 - 05.01 1.0 i (SF310, AA44), 39 kW 09.91 - 05.01 1.3 (SF413, AB35), 50 kW 03.89 - 05.01 1.3 4WD (SF413, AA35) 03.89 - 05.01 1.3 GTi (SF413, AA34) 03.89 - 05.01	11.1996->		

## SWIFT Cabrio/Convertible (SF413)

**09.91 -**



<b>Spurstangenkopf / Tie-rod End</b> Gewindeart: mit Rechtsgewinde / Thread Type: with right-hand thread Gewindemaß / Thread Size: M12x1,25 Innengewinde [mm] / Inner Thread [mm]: M12x1,25 ALL TYPES		<b>15697</b>	<b>48810-82000</b>
			
<b>Faltenbalsatz, Lenkung / Bellow Kit, steering system</b> ALL TYPES		<b>30156</b>	<b>48572-82000</b>
	 ->10.1996		
<b>Faltenbalsatz, Lenkung / Bellow Kit, steering system</b> ALL TYPES		<b>30229</b>	<b>B2113-2125</b>
	11.1996->		







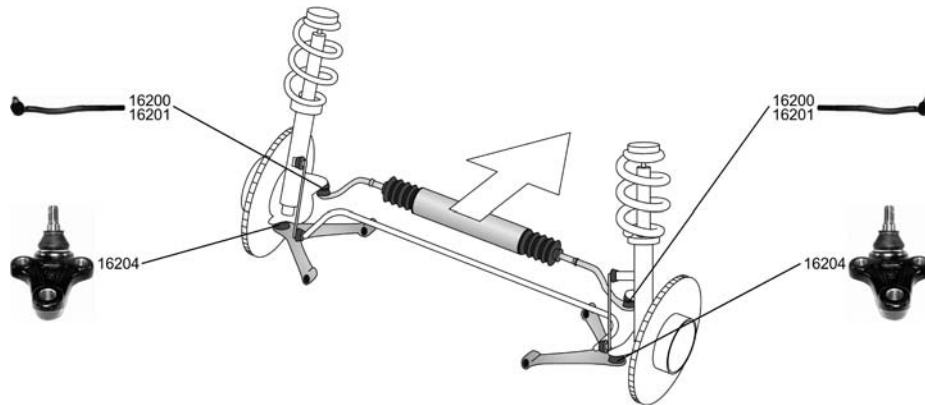

OE

**SUZUKI**

**VITARA (ET, TA)**

**07.88 - 03.98**





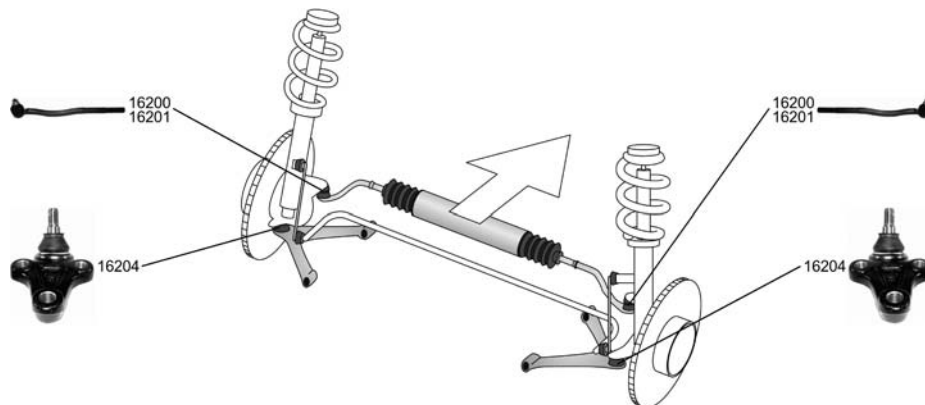

<p><b>Spurstangenkopf / Tie-rod End</b>                  Aussengewinde [mm] / Outer Thread [mm]:M16x1,5                  Gewindeart: mit Linksgewinde / Thread Type: With left-hand thread</p>		<p><b>16200</b>      <b>48820-60A00</b></p>
<p>ALL TYPES</p>		
<p><b>Spurstangenkopf / Tie-rod End</b>                  Gewindeart: mit Rechtsgewinde / Thread Type: with right-hand thread                  Gewindemaß / Thread Size:M16x1,5</p>		<p><b>16201</b>      <b>48810-83300</b></p>
<p>ALL TYPES</p>		
<p><b>Trag-/Führungsgelenk / Support-/ Steering Link</b>                  ALL TYPES</p>		<p><b>16204</b>      <b>45700-60A00</b></p>
		

**VITARA Cabrio/open off-road vehicle/carrosserie ouverte (ET, TA)**

**07.88 - 03.99**



<p><b>Spurstangenkopf / Tie-rod End</b>                  Aussengewinde [mm] / Outer Thread [mm]:M16x1,5                  Gewindeart: mit Linksgewinde / Thread Type: With left-hand thread</p>		<p><b>16200</b>      <b>48820-60A00</b></p>
<p>1.6 (TA)      07.88 - 01.95                  1.6 16V (ET)      07.90 - 03.99                  2.0 16V (ET)      12.96 - 03.99                  1.9 D (ET), 55 kW      08.96 - 03.99</p>		
<p><b>Spurstangenkopf / Tie-rod End</b>                  Gewindeart: mit Rechtsgewinde / Thread Type: with right-hand thread                  Gewindemaß / Thread Size:M16x1,5</p>		<p><b>16201</b>      <b>48810-83300</b></p>
<p>1.6 (TA)      07.88 - 01.95                  1.6 16V (ET)      07.90 - 03.99                  2.0 16V (ET)      12.96 - 03.99                  1.9 D (ET), 55 kW      08.96 - 03.99</p>		





OE

## SUZUKI

VITARA Cabrio/open off-road  
vehicle/carrosserie ouverte (ET, TA)





07.88 - 03.99

	<b>Trag-/Führungsgelenk / Support-/ Steering Link</b>		<b>16204</b>	<b>45700-60A00</b>
	1.6 (TA) 07.88 - 01.95 1.6 16V (ET) 07.90 - 03.99 2.0 16V (ET) 12.96 - 03.99 1.9 D (ET), 55 kW 08.96 - 03.99			

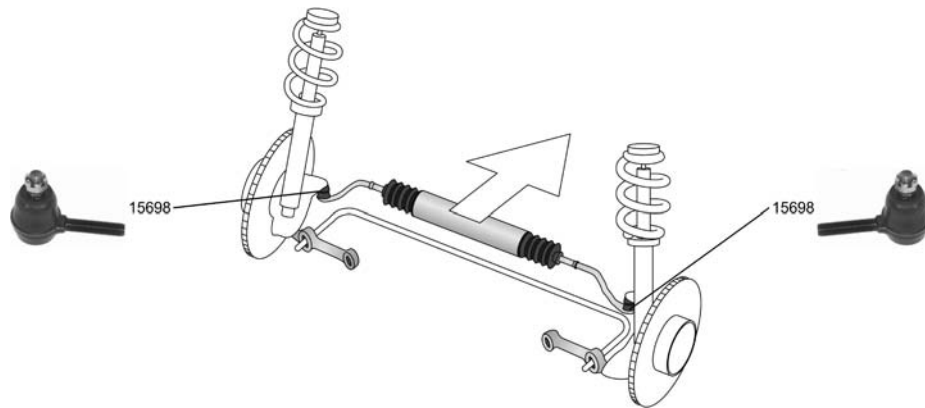
WAGON R+ (EM)

02.98 - 05.00



<b>Spurstangenkopf / Tie-rod End</b> Gewindeart: mit Rechtsgewinde / Thread Type: with right-hand thread Gewindemaß / Thread Size: M12x1,25 Aussengewinde [mm] / Outer Thread [mm]: M12x1,25		<b>15698</b>	<b>48810-84000</b>
ALL TYPES			
<b>Faltenbalgsatz, Lenkung / Bellow Kit, steering system</b>		<b>30156</b>	<b>48572-82000</b>
ALL TYPES			



Artikelnummer Article No.	Seite Page	Hersteller Manufacturer	Artikelnummer Article No.	Seite Page	Hersteller Manufacturer
15690 ▾⊕	4	SUZUKI			
Lenker, Radaufhängung / Track Control Arm					
15692 ▾⊕	4	SUZUKI			
Lenker, Radaufhängung / Track Control Arm					
15697 ⊕↻	2 3 4	SUZUKI			
Spurstangenkopf / Tie-rod End	5 6				
15698 ⊕↻	1 8	SUZUKI			
Spurstangenkopf / Tie-rod End					
15702 ⊕↻	4 5	SUZUKI			
Axialgelenk, Spurstange / Axial Rod, tie rod					
15703 ⊕↻	1	SUZUKI			
Axialgelenk, Spurstange / Axial Rod, tie rod					
16200 ⊕↻	7	SUZUKI			
Spurstangenkopf / Tie-rod End					
16201 ⊕↻	3 7	SUZUKI			
Spurstangenkopf / Tie-rod End					
16204 ▾⊕	7 8	SUZUKI			
Trag-/Führungsgelenk / Support-/ Steering Link					
16206 ▾⊕	1	SUZUKI			
Lenker, Radaufhängung / Track Control Arm					
30156 ⊕	1 2 4	SUZUKI			
Faltenbalgsatz, Lenkung / Bellow Kit, steering system	5 6 8				
30229 ⊕	5 6	SUZUKI			
Faltenbalgsatz, Lenkung / Bellow Kit, steering system					



Vergleichsliste / Cross reference list

Vergleichs-Nr. Compare No.	Artikelnummer Article No.	Vergleichs-Nr. Compare No.	Artikelnummer Article No.	Vergleichs-Nr. Compare No.	Artikelnummer Article No.
<b>SUZUKI</b>					
45200-77500	15690				
45200-82000	15692				
45200-84000	16206				
45700-60A00	16204				
48572-82000	30156				
48810-82000	15697				
48810-83300	16201				
48810-84000	15698				
48820-60A00	16200				
48830-82000	15702				
48830-84000	15703				
B2113-2125	30229				

Neuaufnahmen / New to range

Artikelnummer Article No.	Seite Page	Hersteller Manufacturer	Artikelnummer Article No.	Seite Page	Hersteller Manufacturer
15690 ▾⊕	4	SUZUKI			
15692 ▾⊕	4	SUZUKI			
15702 ⊕☑	4 5	SUZUKI			
15703 ⊕☑	1	SUZUKI			
16201 ⊕☑	3 7	SUZUKI			
16204 ▾⊕	7 8	SUZUKI			
16206 ▾⊕	1	SUZUKI			
30156 ⊕	1 2 4 5 6 8	SUZUKI			
30229 ⊕	5 6	SUZUKI			

Geänderte Bestellnummer / Amended part numbers

Artikelnummer alt Article No. old	Artikelnummer neu Article No. new	Artikelnummer alt Article No. old	Artikelnummer neu Article No. new	Artikelnummer alt Article No. old	Artikelnummer neu Article No. new
15694	30156				

Geänderte Bestellnummer / Amended part numbers

Artikelnummer neu Article No. new	Artikelnummer alt Article No. old	Artikelnummer neu Article No. new	Artikelnummer alt Article No. old	Artikelnummer neu Article No. new	Artikelnummer alt Article No. old
30156	15694				