







OE

ROVER

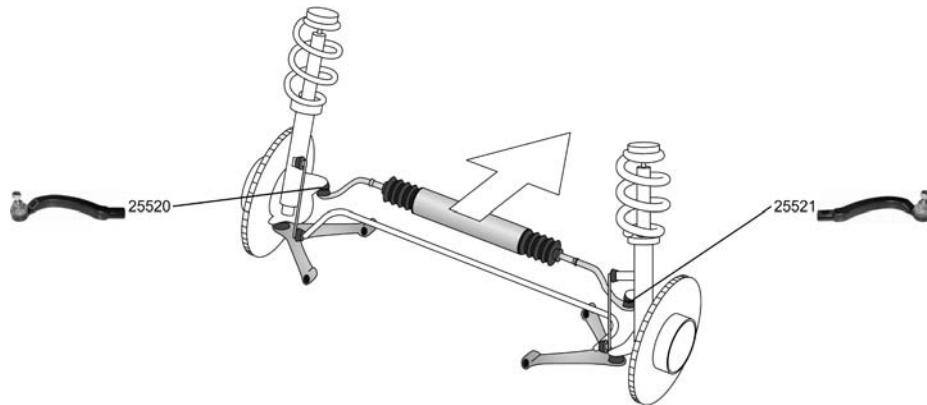
75 (RJ)

02.99 -





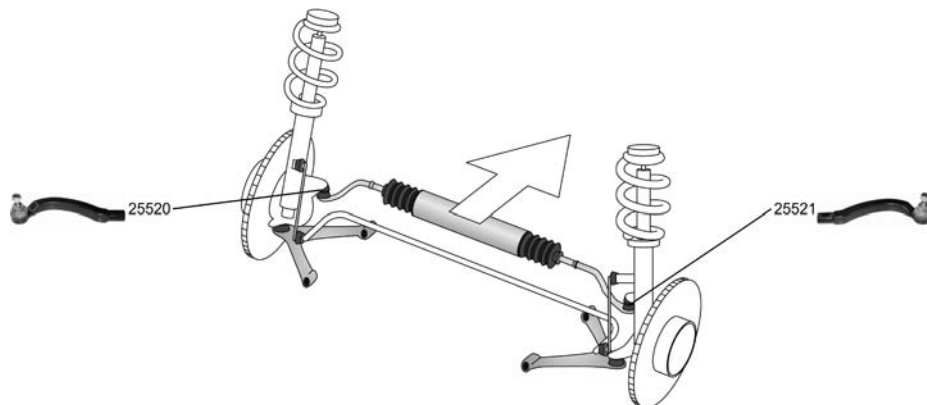

Spurstangenkopf / Tie-rod End		25520	QJB 100 190
ALL TYPES ausser/except for :			
1.8 Turbo	05.03 -		
2.0 CDTi	02.03 -		
Spurstangenkopf / Tie-rod End		25521	GSJ 878
ALL TYPES ausser/except for :			
1.8 Turbo	05.03 -		
2.0 CDTi	02.03 -		

75 Tourer (RJ)

08.01 -



Spurstangenkopf / Tie-rod End		25520	QJB 100 190
1.8	08.01 -		
2.0 V6	08.01 -		
2.5 V6	08.01 -		
2.0 CDT	08.01 -		
Spurstangenkopf / Tie-rod End		25521	GSJ 878
1.8	08.01 -		
2.0 V6	08.01 -		
2.5 V6	08.01 -		
2.0 CDT	08.01 -		



OE

ROVER

100 (METRO) (XP)

11.89 - 12.98

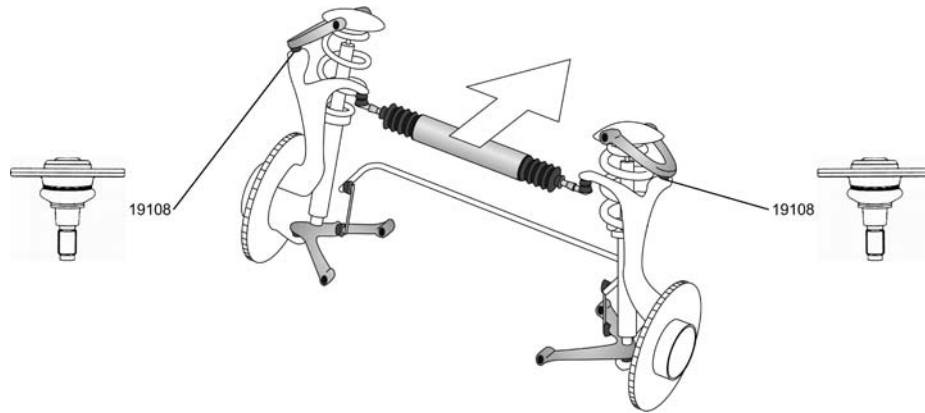

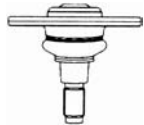
<p>Trag-/Führungsgelenk / Support-/ Steering Link Konusmaß [mm] / Cone Size [mm]:14</p>	<p>▲▲↻♂</p>	<p>19108</p>
<p>ALL TYPES</p>		

100 Cabrio/Convertible (XP)

04.94 - 12.98

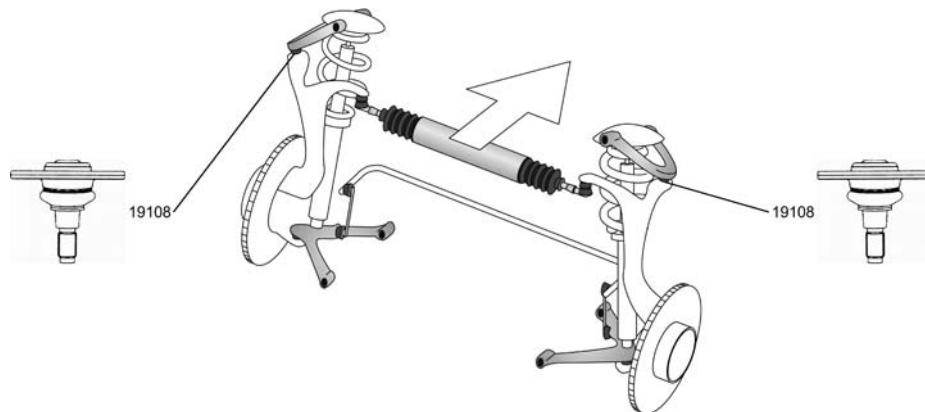

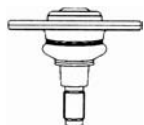
<p>Trag-/Führungsgelenk / Support-/ Steering Link Konusmaß [mm] / Cone Size [mm]:14</p>	<p>▲▲↻♂</p>	<p>19108</p>
<p>ALL TYPES</p>		







OE

ROVER

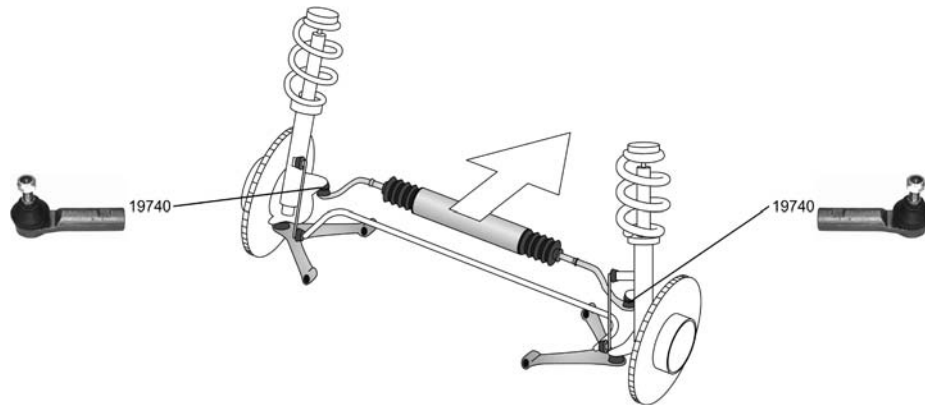
200 Coupe (XW)

10.92 -





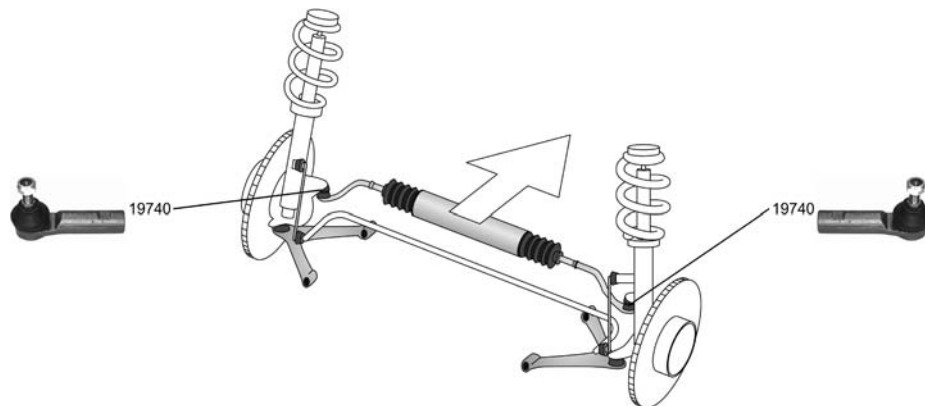

Spurstangenkopf / Tie-rod End mit Zubehör / With accessories			19740 QJB 100 120
216	10.92 -		
220 GSi	05.94 -		
220 Turbo	10.92 -		
Achskörperlager / Mounting, axle body		 (x2)	29991 EGP 1673
216	10.92 -		
220 GSi	05.94 -		
220 Turbo	10.92 -		

200 Hatchback/avec hayon (XW)

10.89 - 10.95



Spurstangenkopf / Tie-rod End mit Zubehör / With accessories			19740 QJB 100 120	
214	09.93 - 10.95			
214 Si/Gsi	10.89 - 10.95			
214 GSi/Si	01.90 - 10.95			
216 GSi	10.89 - 10.95			
216 GTi	09.90 - 10.95			
220 GTi	09.91 - 10.95			
220 Turbo	01.93 - 10.95			
218 D	09.91 - 10.95			
Achskörperlager / Mounting, axle body		 (x2)		29991 EGP 1673
ALL TYPES ausser/except for :				
220 D, SD, SDi (RF)	01.96 -			
214 8V	09.90 - 02.92			
220i 16V SLi	01.93 - 10.95			





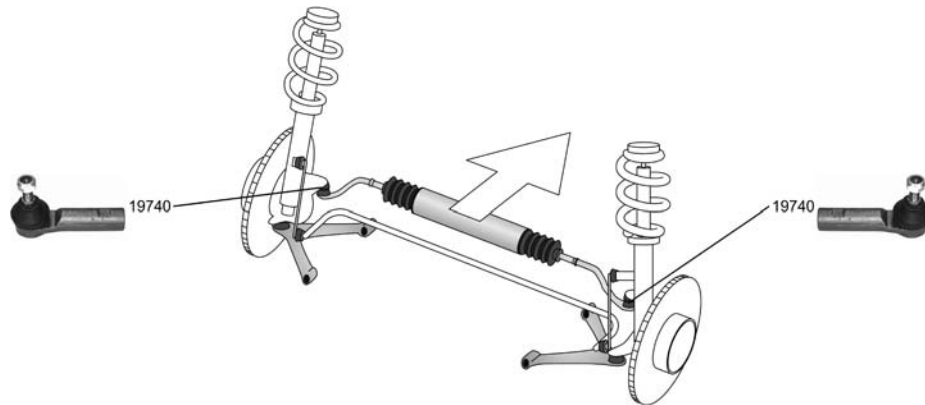

ROVER

200 (RF)

11.95 - 03.00







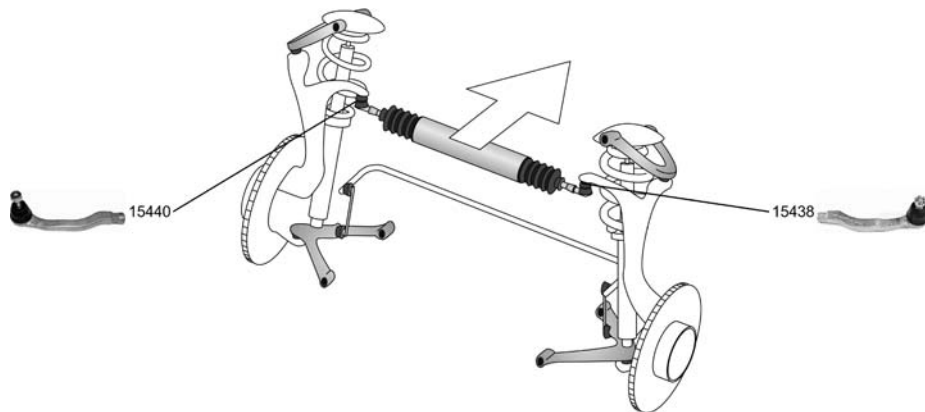

Spurstangenkopf / Tie-rod End mit Zubehör / With accessories ALL TYPES ausser/except for : 200 Vi (RF)		19740 QJB 100 120 
Achskörperlager / Mounting, axle body ALL TYPES ausser/except for : 200 Vi (RF)		29991 EGP 1673 

400 (XW)

04.90 - 04.95



Spurstangenkopf / Tie-rod End Gewindeart: mit Rechtsgewinde / Thread Type: with right-hand thread ALL TYPES		15438 QGX100060 
Spurstangenkopf / Tie-rod End Gewindeart: mit Rechtsgewinde / Thread Type: with right-hand thread ALL TYPES		15440 QGX100050 
Achskörperlager / Mounting, axle body 414 GSI/SI KAT		29991 EGP 1673 







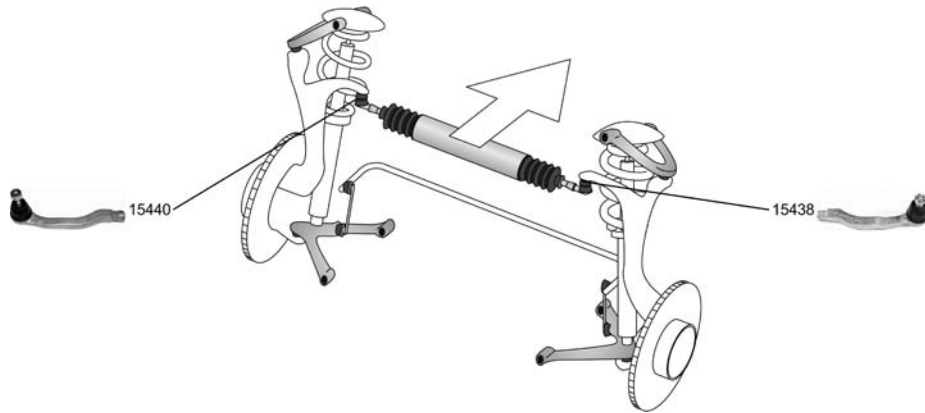

OE

ROVER

400 Tourer/Estate/Break (XW)

09.93 - 11.98





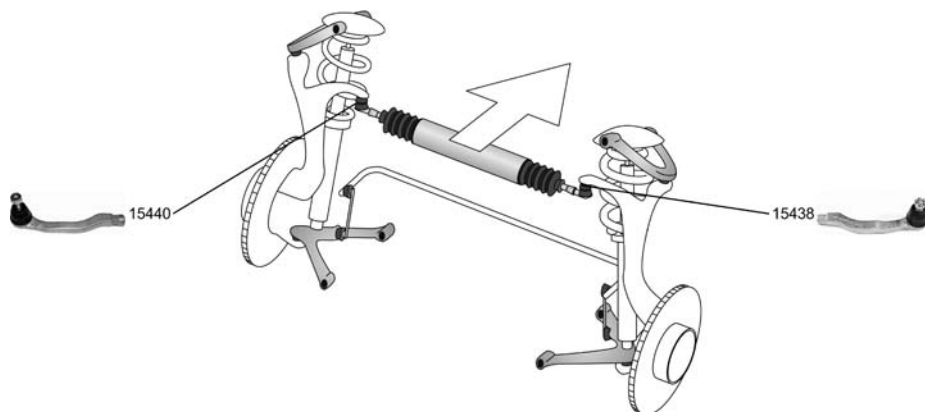

<p>Spurstangenkopf / Tie-rod End Gewindeart: mit Rechtsgewinde / Thread Type: with right-hand thread ALL TYPES ausser/except for : 414 03.96 - 11.98</p>		<p>15438 QGX100060</p> 
<p>Spurstangenkopf / Tie-rod End Gewindeart: mit Rechtsgewinde / Thread Type: with right-hand thread ALL TYPES ausser/except for : 414 03.96 - 11.98</p>		<p>15440 QGX100050</p> 
<p>Achskörperlager / Mounting, axle body ALL TYPES ausser/except for : 414 03.96 - 11.98</p>		<p>29991 EGP 1673</p> 

400 (RT)

05.95 - 03.00



<p>Spurstangenkopf / Tie-rod End Gewindeart: mit Rechtsgewinde / Thread Type: with right-hand thread ALL TYPES ausser/except for : 418 05.96 - 03.00</p>		<p>15438 QGX100060</p> 
<p>Spurstangenkopf / Tie-rod End Gewindeart: mit Rechtsgewinde / Thread Type: with right-hand thread ALL TYPES ausser/except for : 418 05.96 - 03.00</p>		<p>15440 QGX100050</p> 



ROVER





400 (RT) 05.95 - 03.00

	Achskörperlager / Mounting, axle body	▲(x2)	29991	EGP 1673
	ALL TYPES ausser/except for : 418			

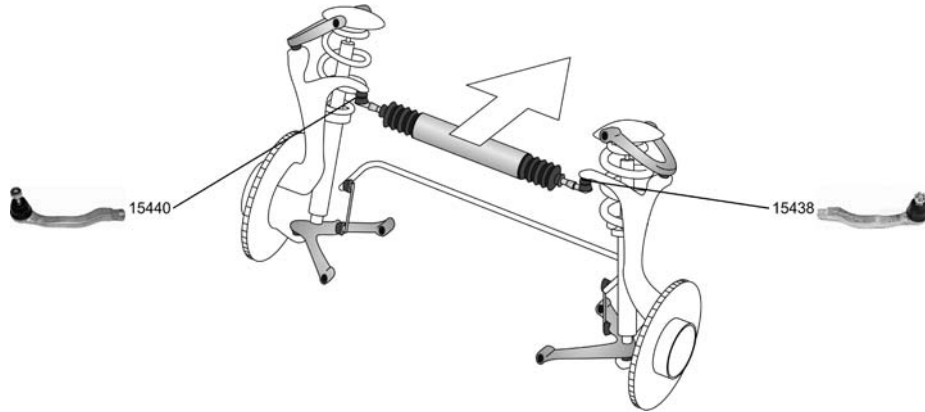

400 Hatchback/avec hayon (RT) 05.95 - 03.00





	Spurstangenkopf / Tie-rod End Gewindeart: mit Rechtsgewinde / Thread Type: with right-hand thread		15438	QGX100060
	ALL TYPES ausser/except for : 418			
	Spurstangenkopf / Tie-rod End Gewindeart: mit Rechtsgewinde / Thread Type: with right-hand thread		15440	QGX100050
	ALL TYPES ausser/except for : 418			
	Achskörperlager / Mounting, axle body	▲(x2)	29991	EGP 1673
	ALL TYPES ausser/except for : 418			

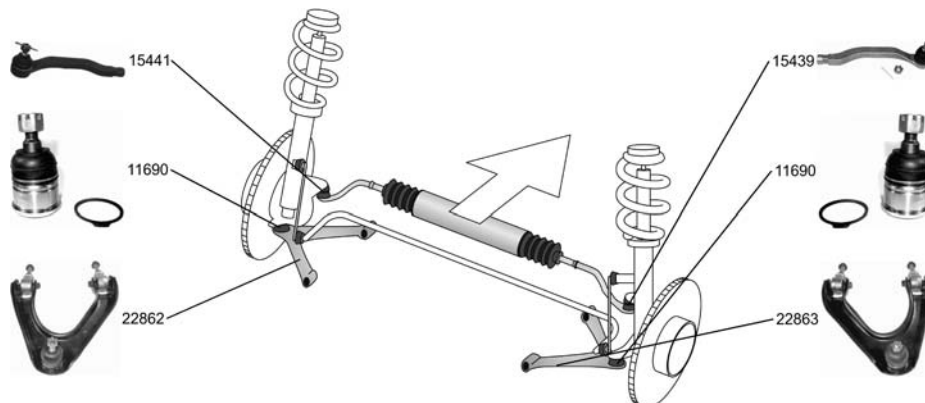

600 (RH) 08.93 - 02.99



	Spurstangenkopf / Tie-rod End Gewindeart: mit Rechtsgewinde / Thread Type: with right-hand thread		15439	GSJ 408
	ALL TYPES			













OE

ROVER

600 (RH)





08.93 - 02.99

 Spurstangenkopf / Tie-rod End Gewindeart: mit Rechtsgewinde / Thread Type: with right-hand thread ALL TYPES		15441 GSJ 407 
Lenker, Radaufhängung / Track Control Arm ALL TYPES		22862 GSJ423 
Lenker, Radaufhängung / Track Control Arm ALL TYPES		22863 GSJ424 
Trag-/Führungsgelenk / Support-/ Steering Link ALL TYPES		11690 

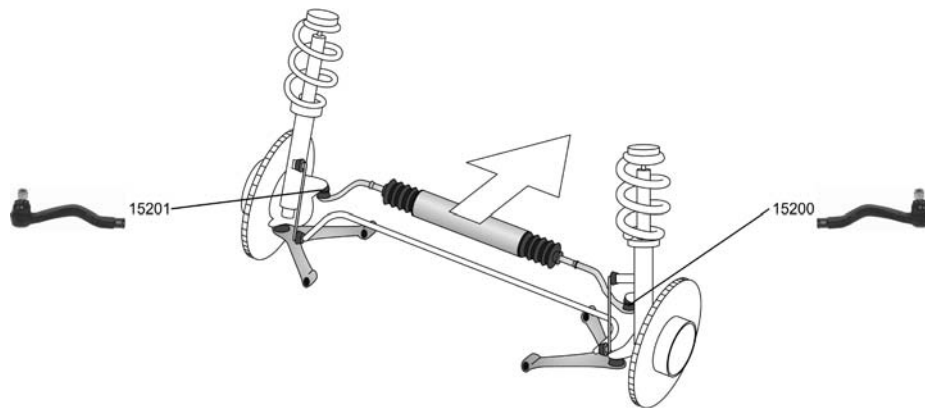
800

10.86 - 02.99



Spurstangenkopf / Tie-rod End Gewindeart: mit Rechtsgewinde / Thread Type: with right-hand thread Gewindemaß / Thread Size: M12x1,5 820 SI (XS) 10.88 - 12.91 820 16 V I/SI (XS) 10.86 - 10.88 820 I/SI (RS) 01.92 - 02.99 820 16V Turbo (RS) 01.92 - 02.99 825 SI/Sterling (XS) KAT 10.86 - 12.91 825 SI/Sterling (XS) 10.86 - 12.91 827 SI/Sterling (XS) KAT 02.88 - 02.99 827 SI/Sterling (XS) 02.88 - 12.91 825 D/SD (XS) 01.90 - 02.99		15200 GSJ 280 
Spurstangenkopf / Tie-rod End Gewindeart: mit Rechtsgewinde / Thread Type: with right-hand thread Gewindemaß / Thread Size: M12x1,25 820 SI (XS) 10.88 - 12.91 820 16 V I/SI (XS) 10.86 - 10.88 820 I/SI (RS) 01.92 - 02.99 820 16V Turbo (RS) 01.92 - 02.99 825 SI/Sterling (XS) KAT 10.86 - 12.91 825 SI/Sterling (XS) 10.86 - 12.91 827 SI/Sterling (XS) KAT 02.88 - 02.99 827 SI/Sterling (XS) 02.88 - 12.91 825 D/SD (XS) 01.90 - 02.99		15201 GSJ 279 





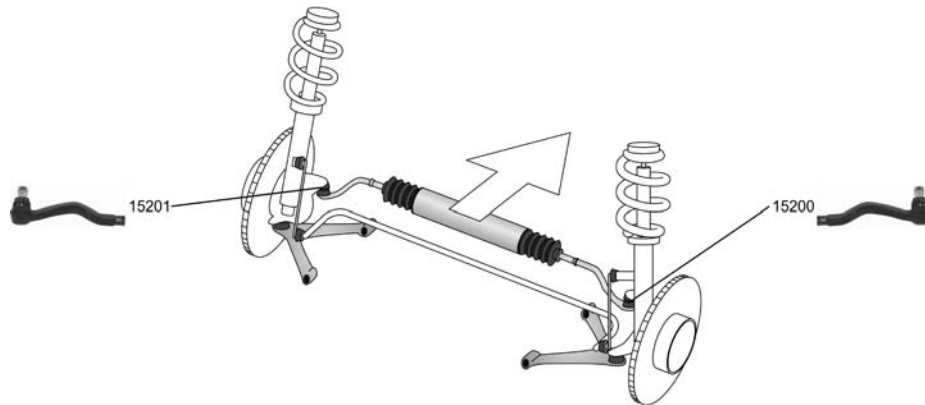

ROVER

800 Coupe

08.92 - 02.99





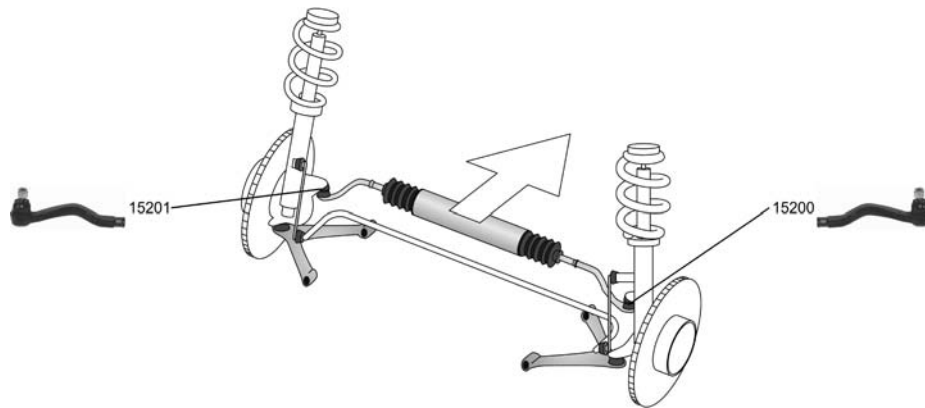

Spurstangenkopf / Tie-rod End Gewindeart: mit Rechtsgewinde / Thread Type: with right-hand thread Gewindemaß / Thread Size: M12x1,5		15200 GSJ 280 
827 24V (RS) 08.92 - 02.99 825 SD 09.93 - 02.99		
Spurstangenkopf / Tie-rod End Gewindeart: mit Rechtsgewinde / Thread Type: with right-hand thread Gewindemaß / Thread Size: M12x1,25		15201 GSJ 279 
827 24V (RS) 08.92 - 02.99 825 SD 09.93 - 02.99		

800 Hatchback/avec hayon

10.86 - 02.99



Spurstangenkopf / Tie-rod End Gewindeart: mit Rechtsgewinde / Thread Type: with right-hand thread Gewindemaß / Thread Size: M12x1,5		15200 GSJ 280 
820 SI (XS) 10.88 - 12.91 820 i/SI (XS) 10.88 - 12.91 820 I/SI (XS) 01.93 - 02.99 820 16V Turbo (RS) 01.92 - 02.99 827 Vitesse (XS) KAT 10.88 - 12.91 827 24V I/SI (RS) KAT 01.92 - 02.99 827 Vitesse/SLI 10.88 - 12.91 825 D/SD (XS) 01.92 - 02.99		
Spurstangenkopf / Tie-rod End Gewindeart: mit Rechtsgewinde / Thread Type: with right-hand thread Gewindemaß / Thread Size: M12x1,25		15201 GSJ 279 
820 SI (XS) 10.88 - 12.91 820 i/SI (XS) 10.88 - 12.91 820 I/SI (XS) 01.93 - 02.99 820 16V Turbo (RS) 01.92 - 02.99 827 Vitesse (XS) KAT 10.88 - 12.91 827 24V I/SI (RS) KAT 01.92 - 02.99 827 Vitesse/SLI 10.88 - 12.91 825 D/SD (XS) 01.92 - 02.99		





OE

ROVER

CABRIOLET (XW)

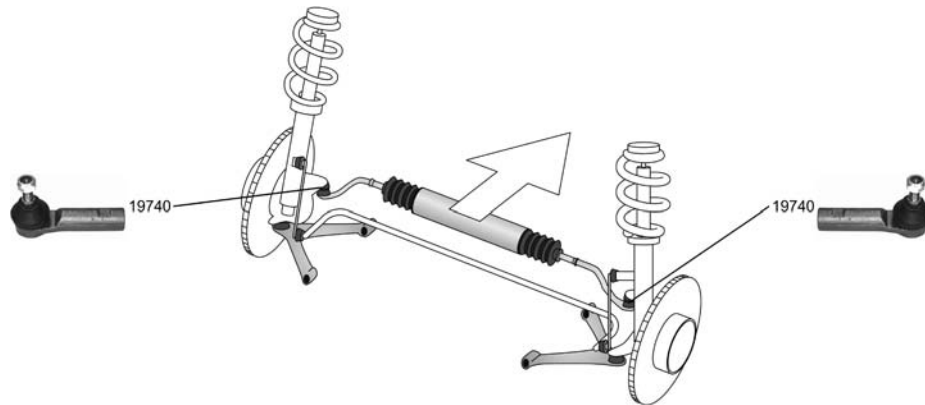
04.90 - 11.99





Spurstangenkopf / Tie-rod End mit Zubehör / With accessories		19740 QJB 100 120 

MAESTRO

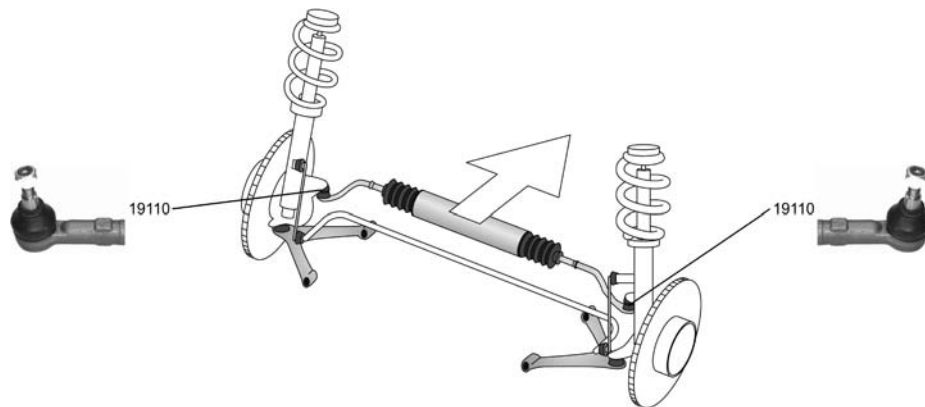
09.90 - 01.95





Spurstangenkopf / Tie-rod End Gewindemaß / Thread Size:M12x1,25 Gewindeart: mit Rechtsgewinde / Thread Type: with right-hand thread ALL TYPES ausser/except for : 2.0 i Turbo M.G.		19110 NAM 3039 

MONTEGO

10.88 - 10.95





Spurstangenkopf / Tie-rod End Gewindemaß / Thread Size:M12x1,25 Gewindeart: mit Rechtsgewinde / Thread Type: with right-hand thread		19110 NAM 3039 

MONTEGO Estate/Break (XE)

10.84 - 12.93



Spurstangenkopf / Tie-rod End Gewindemaß / Thread Size:M12x1,25 Gewindeart: mit Rechtsgewinde / Thread Type: with right-hand thread		19110 NAM 3039 

Arithmetische Liste / Part number list

Artikelnummer Article No.	Seite Page	Hersteller Manufacturer	Artikelnummer Article No.	Seite Page	Hersteller Manufacturer
11690 ▽⊕	7	ROVER			
Trag-/Führungsgelenk / Support-/ Steering Link					
15200 ⊕♂	7 8	ROVER			
Spurstangenkopf / Tie-rod End					
15201 ⊕♂	7 8	ROVER			
Spurstangenkopf / Tie-rod End					
15438 ⊕♂	4 5 6	ROVER			
Spurstangenkopf / Tie-rod End					
15439 ⊕♂	6	ROVER			
Spurstangenkopf / Tie-rod End					
15440 ⊕♂	4 5 6	ROVER			
Spurstangenkopf / Tie-rod End					
15441 ⊕♂	7	ROVER			
Spurstangenkopf / Tie-rod End					
19108 ▲▲⊕♂	2	ROVER			
Trag-/Führungsgelenk / Support-/ Steering Link					
19110 ▲▲⊕♂	9	ROVER			
Spurstangenkopf / Tie-rod End					
19740 ⊕♂	3 4 9	ROVER			
Spurstangenkopf / Tie-rod End					
22862 ▲▲⊕	7	ROVER			
Lenker, Radaufhängung / Track Control Arm					
22863 ▲▲⊕	7	ROVER			
Lenker, Radaufhängung / Track Control Arm					
25520 ⊕♂	1	ROVER			
Spurstangenkopf / Tie-rod End					
25521 ⊕♂	1	ROVER			
Spurstangenkopf / Tie-rod End					
29991 ▲(x2)	3 4 5	ROVER			
Achskörperlager / Mounting, axle body					

Vergleichsliste / Cross reference list

Vergleichs-Nr. Compare No.	Artikelnummer Article No.	Vergleichs-Nr. Compare No.	Artikelnummer Article No.	Vergleichs-Nr. Compare No.	Artikelnummer Article No.
ROVER					
EGP 1673	29991				
GSJ 279	15201				
GSJ 280	15200				
GSJ 407	15441				
GSJ 408	15439				
GSJ 878	25521				
GSJ423	22862				
GSJ424	22863				
NAM 3039	19110				
QGX100050	15440				
QGX100060	15438				
QJB 100 120	19740				
QJB 100 190	25520				

Neuaufnahmen / New to range

Artikelnummer Article No.	Seite Page	Hersteller Manufacturer	Artikelnummer Article No.	Seite Page	Hersteller Manufacturer
15200	7 8	ROVER			
15201	7 8	ROVER			
19740	3 4 9	ROVER			
25520	1	ROVER			
25521	1	ROVER			

Geänderte Bestellnummer / Amended part numbers

Artikelnummer alt Article No. old	Artikelnummer neu Article No. new	Artikelnummer alt Article No. old	Artikelnummer neu Article No. new	Artikelnummer alt Article No. old	Artikelnummer neu Article No. new
22867	15440				

Geänderte Bestellnummer / Amended part numbers

Artikelnummer neu Article No. new	Artikelnummer alt Article No. old	Artikelnummer neu Article No. new	Artikelnummer alt Article No. old	Artikelnummer neu Article No. new	Artikelnummer alt Article No. old
15440	22867				