











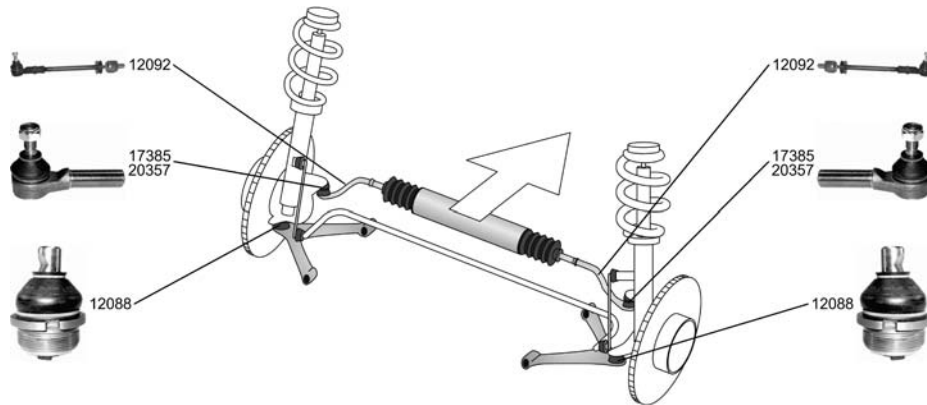

OE

PORSCHE

911

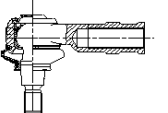
01.63 - 11.90





<p>Spurstange / Tie Rod, steering</p> <p>3.3 SC Turbo 09.77 - 06.87 3.3 Turbo 06.86 - 08.89 3.3 Turbo S 09.86 - 11.90</p>		<p>12092 930 347 031 01</p> 
<p>Spurstangenkopf / Tie-rod End Gewindeart: mit Rechtsgewinde / Thread Type: with right-hand thread Aussengewinde 1 [mm] / Outer Thread 1 [mm]:M14x1,5</p> <p>2.0 L 01.63 - 11.68 2.0 T 08.68 - 02.72 2.2 T 01.70 - 12.72 2.3 T 08.71 - 12.73 2.3 E 08.71 - 12.73 2.3 S 08.71 - 01.76 2.7 09.73 - 06.77 2.7 S Carrera 08.73 - 01.76 2.7 SC Carrera RS 08.72 - 01.79 3.0 SC Carrera 03.74 - 10.83 3.0 SC 08.82 - 07.83 3.0 Turbo 01.75 - 12.77 3.2 08.86 - 08.89 3.2 SC Carrera 08.83 - 08.89</p>		<p>17385 911 347 322 04</p> 
<p>Spurstangenkopf / Tie-rod End Gewindeart: mit Rechtsgewinde / Thread Type: with right-hand thread Innengewinde [mm] / Inner Thread [mm]:M14x1,5</p> <p>3.3 SC Turbo 09.77 - 06.87 3.3 Turbo 06.86 - 08.89 3.3 Turbo S 09.86 - 11.90</p>		<p>20357 930 347 322 00</p> 
<p>Trag-/Führungsgelenk / Support-/ Steering Link ohne Zubehör / without accessories</p> <p>2.7 09.73 - 06.77 2.7 S Carrera 08.73 - 01.76 2.7 SC Carrera RS 08.72 - 01.79 3.0 SC Carrera 03.74 - 10.83 3.0 SC 08.82 - 07.83 3.0 Turbo 01.75 - 12.77 3.2 08.86 - 08.89 3.2 SC Carrera 08.83 - 08.89 3.3 SC Turbo 09.77 - 06.87 3.3 Turbo 06.86 - 08.89 3.3 Turbo S 09.86 - 11.90</p>		<p>12088 911 341 049 01</p> 
<p>Stange/Strebe, Stabilisator / Rod/Strut, stabiliser Pendelstange / Suspension Rod mit Zubehör / With accessories</p> <p>3.0 SC Carrera, 138 kW 09.79 - 06.80 3.0 SC 08.82 - 07.83 3.2 08.86 - 08.89 3.2 SC Carrera 08.83 - 08.89 3.3 Turbo 06.86 - 08.89 2.7 SC Carrera RS 08.72 - 01.79 3.0 SC Carrera, 154 kW 03.74 - 10.83 3.3 SC Turbo 09.77 - 06.87 3.3 Turbo S 09.86 - 11.90</p>		<p>19336 930 333 072 00</p> 
		<p>08.1978-> ->08.1989</p>





PORSCHE





911 01.63 - 11.90

 Stange/Strebe, Stabilisator / Rod/Strut, stabiliser Pendelstange / Suspension Rod		 20356 930 333 071 00	
	3.0 SC Carrera, 138 kW		09.79 - 06.80
	3.0 SC		08.82 - 07.83
	3.2		08.86 - 08.89
	3.2 SC Carrera		08.83 - 08.89
	3.3 Turbo		06.86 - 08.89
	2.7 SC Carrera RS		08.72 - 01.79
3.0 SC Carrera, 154 kW	03.74 - 10.83	08.1978->	
3.3 SC Turbo	09.77 - 06.87		
3.3 Turbo S	09.86 - 11.90	->08.1989	
Stabilisatorlager / Mounting, Stabilizer		 25167 901 343 782 00	
	2.0 L		01.63 - 11.68
	2.0 T		08.68 - 02.72
	2.7		09.73 - 06.77
	2.7 S Carrera		08.73 - 01.76
	3.0 SC Carrera, 147 kW		09.75 - 06.77
	3.0 SC Carrera, 154 kW		03.74 - 10.83
	3.0 Turbo		01.75 - 12.77

911 Cabrio/Convertible 08.82 - 08.89

 Spurstangenkopf / Tie-rod End Gewindeart: mit Rechtsgewinde / Thread Type: with right-hand thread Aussengewinde 1 [mm] / Outer Thread 1 [mm]:M14x1,5 ALL TYPES		17385 911 347 322 04 

911 Targa 11.64 - 11.90

 Spurstangenkopf / Tie-rod End Gewindeart: mit Rechtsgewinde / Thread Type: with right-hand thread Aussengewinde 1 [mm] / Outer Thread 1 [mm]:M14x1,5 ALL TYPES		17385 911 347 322 04 	
			Trag-/Führungsgelenk / Support-/ Steering Link ohne Zubehör / without accessories 2.7 09.73 - 06.77 2.7 S 08.73 - 01.76 2.7 SC Carrera RS 08.72 - 01.79 3.0 SC Carrera 09.75 - 06.80 3.3 Turbo 09.86 - 11.90
 Stabilisatorlager / Mounting, Stabilizer		 25167 901 343 782 00	
	2.0 L		11.64 - 11.68
	2.0 T		06.67 - 02.72
	2.0 E		09.68 - 02.72
	2.0 S		07.66 - 02.72
	2.2 T		01.70 - 12.72
	2.2 E		09.69 - 02.72
	2.7		09.73 - 06.77
	2.7 S		08.73 - 01.76
	3.0 SC Carrera, 147 kW		09.75 - 06.77









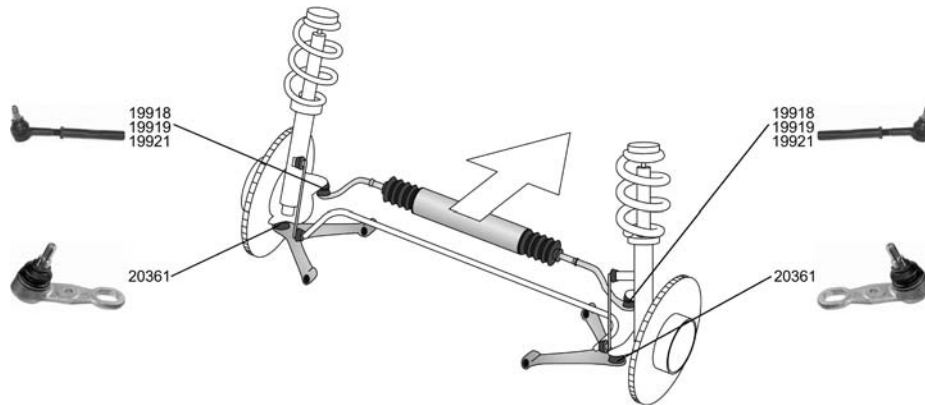

OE

PORSCHE

911 (964)

12.88 - 09.93





<p>Spurstangenkopf / Tie-rod End Gewindeart: mit Rechtsgewinde / Thread Type: with right-hand thread Gewindemaß / Thread Size:M14x1,5</p>		<p>19918 964 347 032 00</p> 
<p>3.6 Carrera 07.89 - 09.93 3.6 Carrera 4 12.88 - 09.93 3.6 Carrera RS 06.91 - 09.93</p>		
<p>Spurstangenkopf / Tie-rod End Gewindeart: für Rechtsgewinde / Thread Type: For right-hand thread</p>		<p>19919 965 347 032 00</p> 
<p>3.6 Carrera 07.89 - 09.93 3.3 Turbo 08.90 - 09.93 3.3 Turbo S 06.91 - 12.92 3.6 Turbo 01.93 - 09.93</p>	für / for: TURBO-LOOK	
<p>Spurstangenkopf / Tie-rod End Gewindeart: mit Rechtsgewinde / Thread Type: with right-hand thread Aussengewinde [mm] / Outer Thread [mm]:M14x1,5</p>		<p>19921 964 347 322 02</p> 
<p>3.6 Carrera 07.89 - 09.93 3.6 Carrera 4 12.88 - 09.93 3.6 Carrera 07.89 - 09.93 3.6 Carrera 4 12.88 - 09.93 3.3 Turbo 08.90 - 09.93 3.3 Turbo S 06.91 - 12.92 3.6 Carrera RS 06.91 - 09.93 3.6 Turbo 01.93 - 09.93</p>	für / for: TURBO-LOOK	
<p>Trag-/Führungsgelenk / Support-/ Steering Link</p>		<p>20361 964 341 049 03</p> 
<p>ALL TYPES ausser/except for : Carrera 2 RS Amerika 01.92 - 12.93 Carrera 2 Speedster 01.93 - 12.94</p>		

911 Cabrio/Convertible (964)

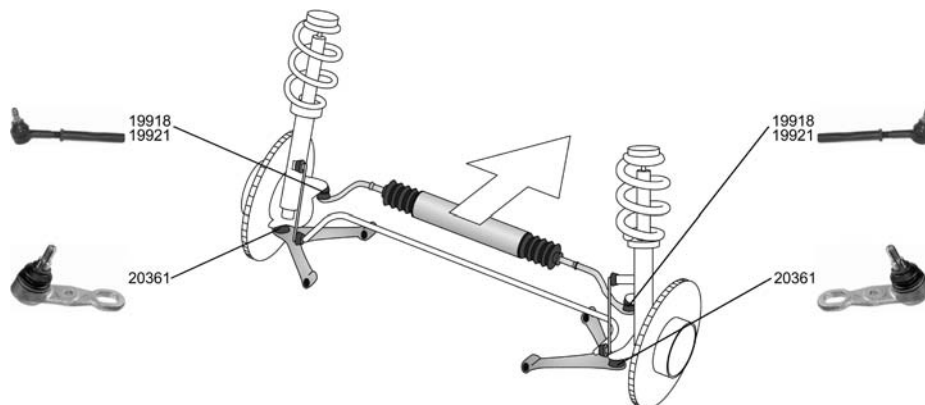
05.89 - 06.94







<p>Spurstangenkopf / Tie-rod End Gewindeart: mit Rechtsgewinde / Thread Type: with right-hand thread Gewindemaß / Thread Size:M14x1,5</p>		<p>19918 964 347 032 00</p> 
<p>ALL TYPES</p>		



PORSCHE

911 Cabrio/Convertible (964)







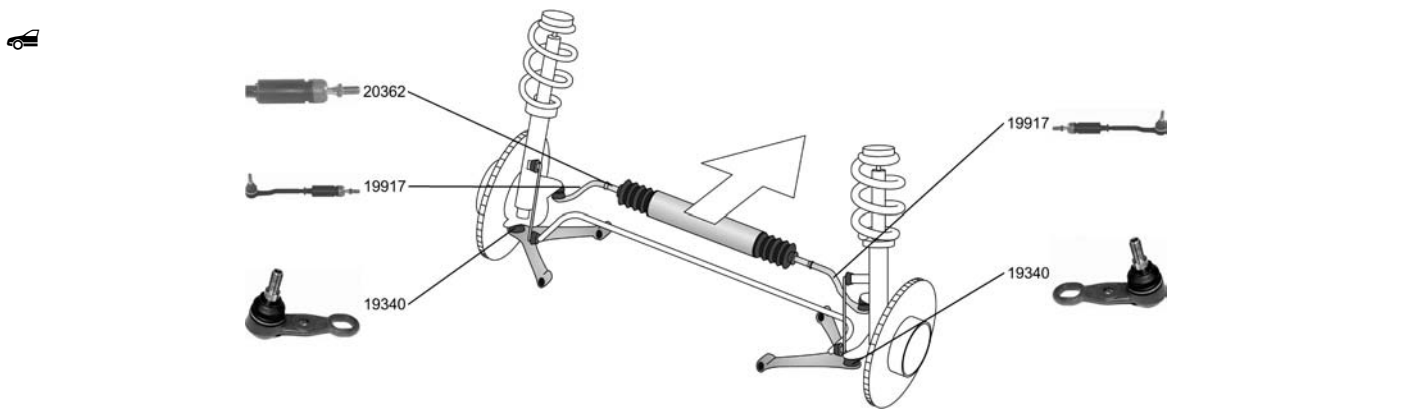

05.89 - 06.94

 Spurstangenkopf / Tie-rod End Gewindeart: mit Rechtsgewinde / Thread Type: with right-hand thread Aussengewinde [mm] / Outer Thread [mm]:M14x1,5		19921 964 347 322 02	
	ALL TYPES		
Trag-/Führungsgelenk / Support-/ Steering Link ALL TYPES		20361 964 341 049 03	
	ALL TYPES		

911 (993)

10.93 - 09.97



Spurstange / Tie Rod, steering 3.8 Carrera RS 06.95 - 09.97 3.8 Carrera RS 4 08.95 - 09.97		19917 993 347 038 81	
Axialgelenk, Spurstange / Axial Rod, tie rod Gewindeart: mit Rechtsgewinde / Thread Type: with right-hand thread Gewindemaß / Thread Size:M14x1,5 ALL TYPES ausser/except for : Carrera RS Clubsport 01.95 - Carrera S 01.97 - 3.6 Carrera, 210 kW 08.95 - 09.97		20362 993 347 131 01	
Trag-/Führungsgelenk / Support-/ Steering Link mit Zubehör / With accessories 3.6 Carrera, 200 kW 10.93 - 08.95 3.6 Carrera 4 07.94 - 09.97 3.6 Turbo 4 03.95 - 09.97 3.6 Turbo GT2 03.95 - 09.97 3.6 Turbo GT2 4, 316 kW 08.95 - 09.97 3.8 Carrera 06.95 - 09.97 3.8 Carrera 4 06.95 - 09.97 3.8 Carrera RS 06.95 - 09.97 3.8 Carrera RS 4 08.95 - 09.97		19340 993 341 049 02	
 Stange/Strebe, Stabilisator / Rod/Strut, stabiliser Pendelstange / Suspension Rod Aussengewinde [mm] / Outer Thread [mm]:M10x1,5 ohne Zubehör / without accessories ALL TYPES ausser/except for : Carrera RS Clubsport 01.95 - Carrera S 01.97 -		26049 993 333 073 80	











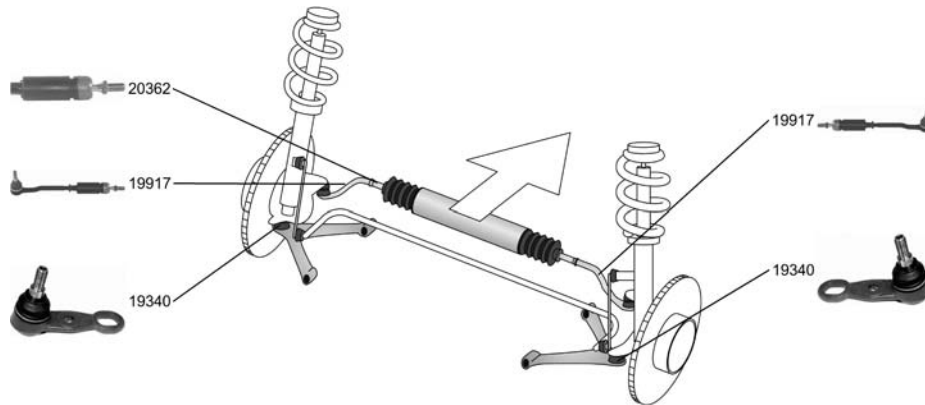

OE

PORSCHE

911 Cabrio/Convertible (993)

07.94 - 09.97





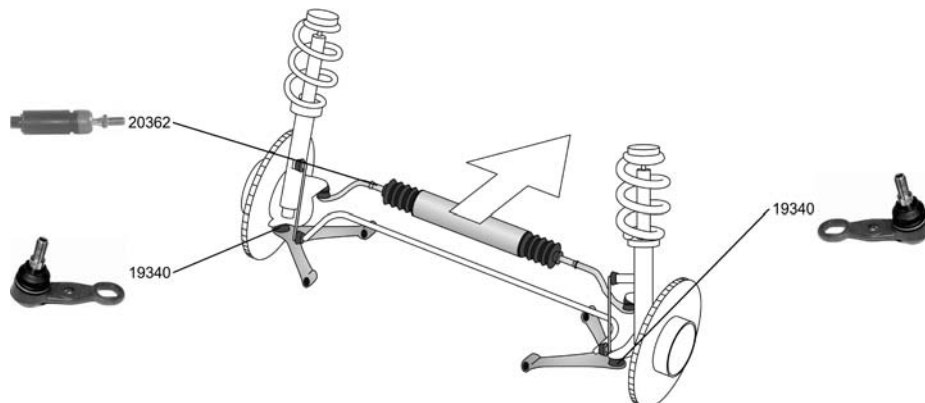

Spurstange / Tie Rod, steering		19917 993 347 038 81
3.8 Carrera RS 3.8 Carrera RS 4	08.95 - 09.97 08.95 - 09.97	
Axialgelenk, Spurstange / Axial Rod, tie rod Gewindeart: mit Rechtsgewinde / Thread Type: with right-hand thread Gewindemaß / Thread Size: M14x1,5 ALL TYPES		20362 993 347 131 01 
Trag-/Führungsgelenk / Support-/ Steering Link mit Zubehör / With accessories ALL TYPES		19340 993 341 049 02 
 Stange/Strebe, Stabilisator / Rod/Strut, stabiliser Pendelstange / Suspension Rod Aussengewinde [mm] / Outer Thread [mm]: M10x1,5 ohne Zubehör / without accessories ALL TYPES		26049 993 333 073 80 

911 Targa (993)

01.94 - 09.97





Axialgelenk, Spurstange / Axial Rod, tie rod Gewindeart: mit Rechtsgewinde / Thread Type: with right-hand thread Gewindemaß / Thread Size: M14x1,5 ALL TYPES		20362 993 347 131 01 
Trag-/Führungsgelenk / Support-/ Steering Link mit Zubehör / With accessories ALL TYPES		19340 993 341 049 02 





PORSCHE



911 Targa (993) 01.94 - 09.97

	Stange/Strebe, Stabilisator / Rod/Strut, stabiliser Pendelstange / Suspension Rod Aussengewinde [mm] / Outer Thread [mm]:M10x1,5 ohne Zubehör / without accessories		26049	993 333 073 80	
	ALL TYPES				



911 (996) 09.97 -

	Spurstangenkopf / Tie-rod End		29646	996 347 131 04	
	3.4 Carrera 09.97 - 09.01 3.4 Carrera 4 06.97 - 09.01 3.6 Carrera 10.01 - 3.6 Carrera 4S, 235 kW 10.01 - 3.6 Carrera S 02.03 - 3.6 Carrera 4S, 254 kW 02.03 - 3.6 Turbo 4 06.00 - 3.6 Turbo 4S 02.03 -				

911 Targa (996) 12.01 -







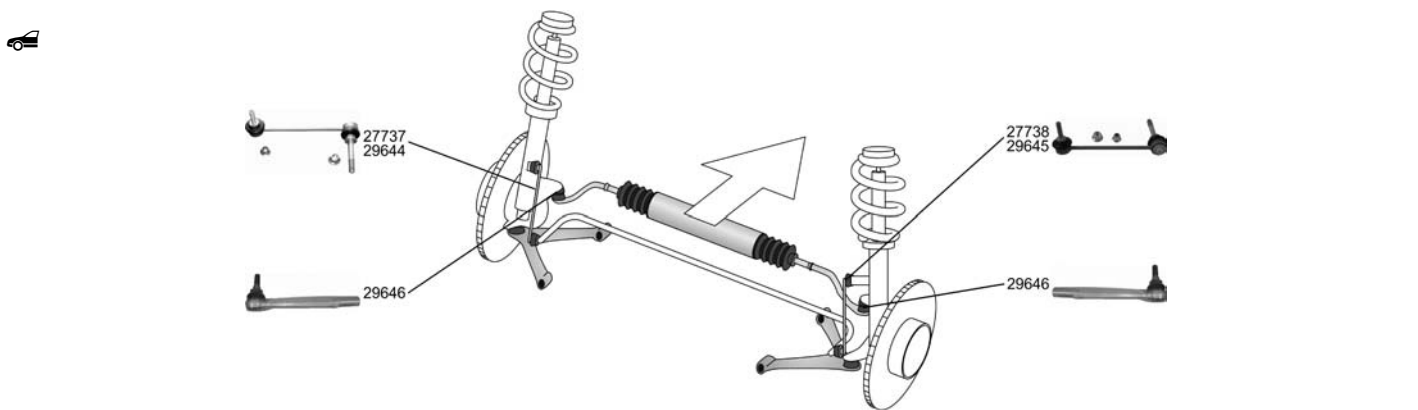

	Spurstangenkopf / Tie-rod End		29646	996 347 131 04	
	ALL TYPES				

911 Cabrio/Convertible (996) 02.98 -

	Spurstangenkopf / Tie-rod End		29646	996 347 131 04	
	ALL TYPES ausser/except for : 3.6 Carrera 4S, 235 kW 01.03 -				

911 (997) 07.04 -

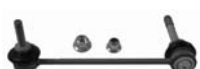

	Spurstangenkopf / Tie-rod End		29646	996 347 131 04	
	3.6 Carrera 07.04 - 3.8 Carrera S 07.04 -				
	Stange/Strebe, Stabilisator / Rod/Strut, stabiliser Pendelstange / Suspension Rod mit Zubehör / With accessories		27737	997 343 069 00	
	3.6 Carrera 07.04 - 3.8 Carrera S 07.04 -				
	Stange/Strebe, Stabilisator / Rod/Strut, stabiliser Pendelstange / Suspension Rod mit Zubehör / With accessories		27738	997 343 070 00	
	3.6 Carrera 07.04 - 3.8 Carrera S 07.04 -				





OE

PORSCHE

911 (997)



07.04 -

 Stange/Strebe, Stabilisator / Rod/Strut, stabiliser Pendelstange / Suspension Rod Rohr-Ø [mm] / Pipe Ø [mm]:9		29644 997 343 073 02 
		3.6 Carrera 4 07.04 - 3.8 Carrera 4S 07.04 -
Stange/Strebe, Stabilisator / Rod/Strut, stabiliser Pendelstange / Suspension Rod Rohr-Ø [mm] / Pipe Ø [mm]:9		29645 997 343 074 02 
		3.6 Carrera 4 07.04 - 3.8 Carrera 4S 07.04 -
 Stange/Strebe, Stabilisator / Rod/Strut, stabiliser Pendelstange / Suspension Rod mit Zubehör / With accessories		27739 997 333 069 04 
		3.6 Carrera 07.04 - 3.8 Carrera S 07.04 -
Stange/Strebe, Stabilisator / Rod/Strut, stabiliser Pendelstange / Suspension Rod mit Zubehör / With accessories		27740 997 333 070 04 
		3.6 Carrera 07.04 - 3.8 Carrera S 07.04 -

911 Cabriolet (997)

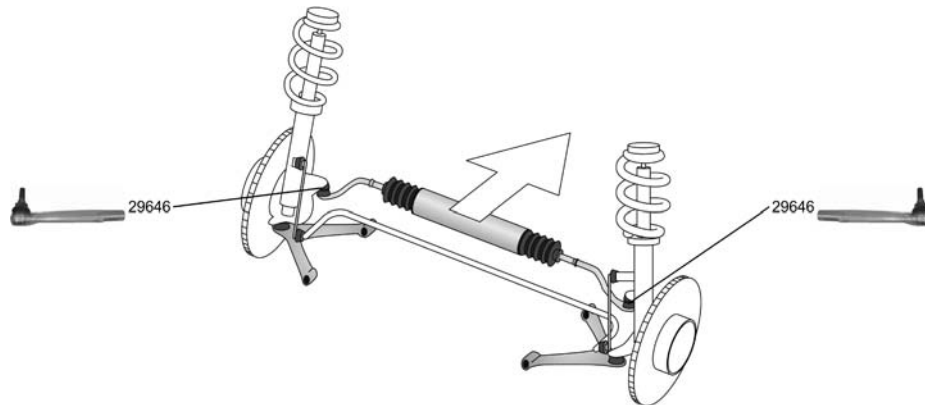







04.05 -



Spurstangenkopf / Tie-rod End 3.6 Carrera 04.05 - 3.8 Carrera S 04.05 -		29646 996 347 131 04 

924









11.75 - 07.88

 Spurstange / Tie Rod, steering 2.0 11.75 - 08.89 2.0 Turbo, 130 kW 06.80 - 10.86 2.0 Carrera GT 06.80 - 10.86 2.5 S, 110 kW 09.85 - 07.87 2.5 S, 118 kW 08.87 - 07.88	 	12093 944 347 033 01 
		Chass. 92DN402094->
Spurstangenkopf / Tie-rod End Konusmaß [mm] / Cone Size [mm]:14 Innengewinde [mm] / Inner Thread [mm]:M14x1,5 Gewindeart: mit Rechtsgewinde / Thread Type: with right-hand thread mit Zubehör / With accessories Gewindemaß / Thread Size:M14x1,5	 	10251 477 419 815 
		2.0 11.75 - 08.89 2.0 Turbo, 130 kW 06.80 - 10.86 2.0 Carrera GT 06.80 - 10.86 2.0 Turbo, 125 kW 11.78 - 06.80 2.5 S, 110 kW 09.85 - 07.87 2.5 S, 118 kW 08.87 - 07.88
		->Chass. 92DN402093
		







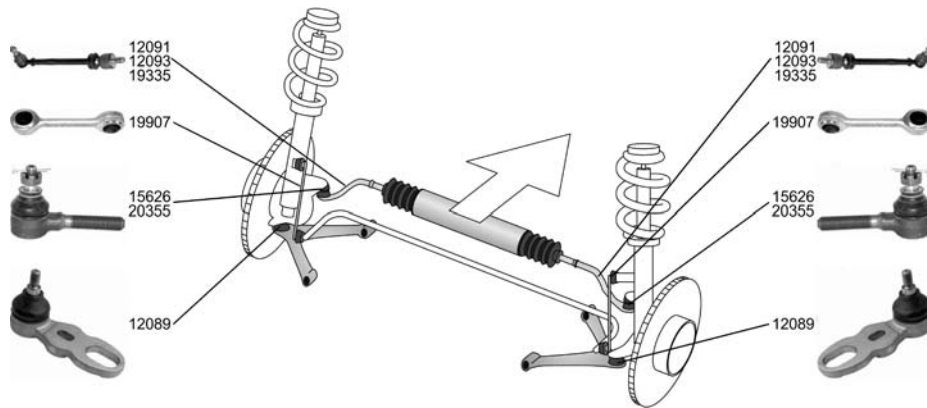

PORSCHE

924 11.75 - 07.88

<p> Spurstangenkopf / Tie-rod End Gewindeart: mit Rechtsgewinde / Thread Type: with right-hand thread Aussengewinde 1 [mm] / Outer Thread 1 [mm]:M14x1,5</p> <table border="1"> <tr><td>2.0</td><td>11.75 - 08.89</td><td rowspan="5">Chass. 92DN402094-></td></tr> <tr><td>2.0 Turbo, 130 kW</td><td>06.80 - 10.86</td></tr> <tr><td>2.0 Carrera GT</td><td>06.80 - 10.86</td></tr> <tr><td>2.5 S, 110 kW</td><td>09.85 - 07.87</td></tr> <tr><td>2.5 S, 118 kW</td><td>08.87 - 07.88</td></tr> </table>	2.0	11.75 - 08.89	Chass. 92DN402094->	2.0 Turbo, 130 kW	06.80 - 10.86	2.0 Carrera GT	06.80 - 10.86	2.5 S, 110 kW	09.85 - 07.87	2.5 S, 118 kW	08.87 - 07.88		<p>15626 944 347 333 01</p> 
2.0	11.75 - 08.89	Chass. 92DN402094->											
2.0 Turbo, 130 kW	06.80 - 10.86												
2.0 Carrera GT	06.80 - 10.86												
2.5 S, 110 kW	09.85 - 07.87												
2.5 S, 118 kW	08.87 - 07.88												
<p>Lenker, Radaufhängung / Track Control Arm ohne Trag-/Führungsgelenk / without support/ steering link ohne Gummilager / without rubber mounting</p> <table border="1"> <tr><td>2.0</td><td>11.75 - 08.89</td><td rowspan="2">Chass. 92CN402198-></td></tr> <tr><td>2.5 S</td><td>10.81 - 07.88</td></tr> </table>	2.0	11.75 - 08.89	Chass. 92CN402198->	2.5 S	10.81 - 07.88		<p>10165 171 407 153 D</p> 						
2.0	11.75 - 08.89	Chass. 92CN402198->											
2.5 S	10.81 - 07.88												
<p>Trag-/Führungsgelenk / Support-/ Steering Link</p> <table border="1"> <tr><td>2.0</td><td>11.75 - 08.89</td><td rowspan="4">01.1978-></td></tr> <tr><td>2.0 Turbo</td><td>11.78 - 10.86</td></tr> <tr><td>2.0 Carrera GT</td><td>06.80 - 10.86</td></tr> <tr><td>2.5 S</td><td>10.81 - 07.88</td></tr> </table>	2.0	11.75 - 08.89	01.1978->	2.0 Turbo	11.78 - 10.86	2.0 Carrera GT	06.80 - 10.86	2.5 S	10.81 - 07.88	 A17	<p>10160 171 407 365 F</p> 		
2.0	11.75 - 08.89	01.1978->											
2.0 Turbo	11.78 - 10.86												
2.0 Carrera GT	06.80 - 10.86												
2.5 S	10.81 - 07.88												
<p>Trag-/Führungsgelenk / Support-/ Steering Link Bohrung-Ø 1 / Bohrung-Ø 2 [mm] / Bore Ø 1 / Bore Ø 2 [mm]:7,0</p> <table border="1"> <tr><td>2.0</td><td>11.75 - 08.89</td><td>->12.1977</td></tr> </table>	2.0	11.75 - 08.89	->12.1977		<p>13779 171 407 365 C</p> 								
2.0	11.75 - 08.89	->12.1977											

928 09.77 - 11.95











<p>Spurstange / Tie Rod, steering</p> <table border="1"> <tr><td>4.4</td><td>09.77 - 08.82</td></tr> <tr><td>4.6 S</td><td>09.79 - 07.86</td></tr> </table>	4.4	09.77 - 08.82	4.6 S	09.79 - 07.86		<p>12091 928 347 031 01</p> 								
4.4	09.77 - 08.82													
4.6 S	09.79 - 07.86													
<p>Spurstange / Tie Rod, steering</p> <table border="1"> <tr><td>4.4</td><td>09.77 - 08.82</td></tr> <tr><td>4.6 S, 221 kW</td><td>09.79 - 07.83</td></tr> <tr><td>4.6 S, 228 kW</td><td>08.83 - 07.86</td></tr> </table>	4.4	09.77 - 08.82	4.6 S, 221 kW	09.79 - 07.83	4.6 S, 228 kW	08.83 - 07.86	 ->12.1985 ->Chass. 92FS..	<p>12093 944 347 033 01</p> 						
4.4	09.77 - 08.82													
4.6 S, 221 kW	09.79 - 07.83													
4.6 S, 228 kW	08.83 - 07.86													
<p>Spurstange / Tie Rod, steering</p> <table border="1"> <tr><td>4.6 S, 228 kW</td><td>08.83 - 07.86</td></tr> <tr><td>4.9 S</td><td>09.85 - 05.94</td></tr> <tr><td>4.9 S,S4</td><td>08.86 - 07.91</td></tr> <tr><td>5.0 S4 KAT</td><td>08.86 - 07.91</td></tr> <tr><td>5.0 GT</td><td>01.89 - 07.91</td></tr> <tr><td>5.4 GTS</td><td>08.91 - 11.95</td></tr> </table>	4.6 S, 228 kW	08.83 - 07.86	4.9 S	09.85 - 05.94	4.9 S,S4	08.86 - 07.91	5.0 S4 KAT	08.86 - 07.91	5.0 GT	01.89 - 07.91	5.4 GTS	08.91 - 11.95	 01.1986-> Chass. 92GS..->	<p>19335 928 347 031 07</p> 
4.6 S, 228 kW	08.83 - 07.86													
4.9 S	09.85 - 05.94													
4.9 S,S4	08.86 - 07.91													
5.0 S4 KAT	08.86 - 07.91													
5.0 GT	01.89 - 07.91													
5.4 GTS	08.91 - 11.95													



OE





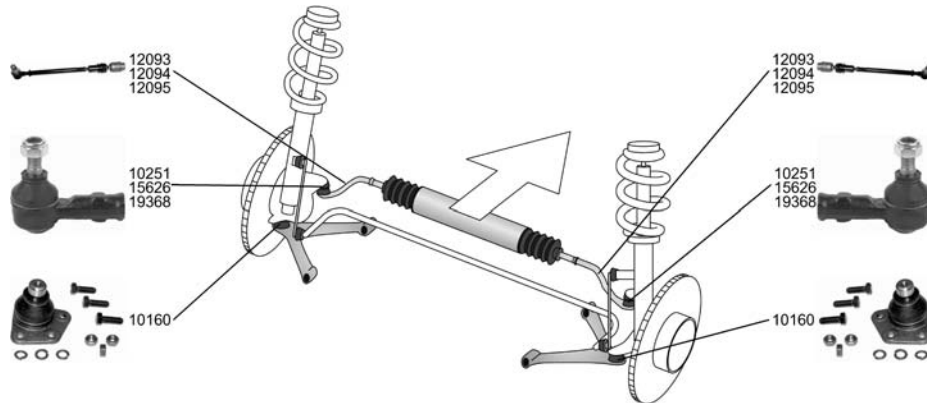

PORSCHE

928 **09.77 - 11.95**

 Spurstangenkopf / Tie-rod End Gewindeart: mit Rechtsgewinde / Thread Type: with right-hand thread Aussengewinde 1 [mm] / Outer Thread 1 [mm]:M14x1,5			15626 944 347 333 01
	4.4	09.77 - 08.82	 ->12.1985 ->Chass. 92FS..
	4.6 S, 221 kW	09.79 - 07.83	
4.6 S, 228 kW	08.83 - 07.86		
Spurstangenkopf / Tie-rod End Gewindeart: mit Rechtsgewinde / Thread Type: with right-hand thread Aussengewinde [mm] / Outer Thread [mm]:M14x1,5			20355 928 347 322 02
	4.6 S, 228 kW	08.83 - 07.86	 01.1986-> Chass. 92GS..->
	4.9 S	09.85 - 05.94	
	4.9 S,S4	08.86 - 07.91	
	5.0 S4 KAT	08.86 - 07.91	
5.0 GT	01.89 - 07.91		
5.4 GTS	08.91 - 11.95		
Trag-/Führungsgelenk / Support-/ Steering Link			12089 928 341 049 12
	4.4	09.77 - 08.82	 4.6 S 09.79 - 07.86
4.6 S	09.79 - 07.86		
Stange/Strebe, Stabilisator / Rod/Strut, stabiliser Pendelstange / Suspension Rod mit Zubehör / With accessories ALL TYPES			19907 928 343 069 01
			

944 **06.81 - 07.91**















Spurstange / Tie Rod, steering 2.5, 110 kW 2.5, 120 kW 2.5 S 2.5 Turbo, 162 kW 2.5, 118 kW			12093 944 347 033 01
	01.85 - 07.87	->12.1986	 06.81 - 07.87 08.86 - 07.88 08.85 - 07.88 08.87 - 12.90
	06.81 - 07.87		
	08.86 - 07.88		
	08.85 - 07.88		
08.87 - 12.90			
Spurstange / Tie Rod, steering 2.5, 110 kW 2.5, 120 kW 2.5 S 2.5 Turbo, 162 kW			12094 944 347 033 20
	01.85 - 07.87	->12.1986	 06.81 - 07.87 08.86 - 07.88 08.85 - 07.88
	06.81 - 07.87		
	08.86 - 07.88		
08.85 - 07.88			
Spurstange / Tie Rod, steering Aussengewinde [mm] / Outer Thread [mm]:M12x1,5 mit Zubehör / With accessories			12095 944 347 033 23
	01.85 - 07.87	01.1987-> 06.81 - 07.87 08.86 - 07.88 08.85 - 07.88 08.87 - 12.90 09.87 - 07.91 11.88 - 08.89 12.88 - 07.91	 2.5, 110 kW 2.5, 120 kW 2.5 S 2.5 Turbo, 162 kW 2.5, 118 kW 2.5 Turbo, 184 kW 2.7 3.0 S2
	06.81 - 07.87		
	08.86 - 07.88		
	08.85 - 07.88		
	08.87 - 12.90		
	09.87 - 07.91		
	11.88 - 08.89		
12.88 - 07.91			





PORSCHE

944 **06.81 - 07.91**

<p> Spurstangenkopf / Tie-rod End Konusmaß [mm] / Cone Size [mm]:14 Innengewinde [mm] / Inner Thread [mm]:M14x1,5 Gewindeart: mit Rechtsgewinde / Thread Type: with right-hand thread mit Zubehör / With accessories Gewindemaß / Thread Size:M14x1,5</p>	<p></p>	<p>10251 477 419 815</p> 
<p>2.5, 110 kW 01.85 - 07.87 2.5, 120 kW 06.81 - 07.87</p>	<p> ->12.1986</p>	
<p>2.5, 118 kW 08.87 - 12.90 2.5 S 08.86 - 07.88 2.5 Turbo 08.85 - 07.91 2.7 11.88 - 08.89 3.0 S2 12.88 - 07.91</p>	<p></p>	
<p>Spurstangenkopf / Tie-rod End Gewindeart: mit Rechtsgewinde / Thread Type: with right-hand thread Aussengewinde 1 [mm] / Outer Thread 1 [mm]:M14x1,5</p>	<p></p>	<p>15626 944 347 333 01</p> 
<p>2.5, 110 kW 01.85 - 07.87 2.5, 120 kW 06.81 - 07.87 2.5 S 08.86 - 07.88 2.5 Turbo, 162 kW 08.85 - 07.88 2.5, 118 kW 08.87 - 12.90</p>	<p>->12.1986</p>	
<p>Spurstangenkopf / Tie-rod End Gewindeart: mit Rechtsgewinde / Thread Type: with right-hand thread Innengewinde [mm] / Inner Thread [mm]:M14x1,5</p>	<p></p>	<p>19368 944 347 333 04</p> 
<p>2.5, 110 kW 01.85 - 07.87</p>	<p>01.1987-></p>	
<p>Lenker, Radaufhängung / Track Control Arm ohne Trag-/Führungsgelenk / without support/ steering link ohne Gummilager / without rubber mounting</p>	<p></p>	<p>10165 171 407 153 D</p> 
<p>2.5, 120 kW 06.81 - 07.87</p>	<p>->01.1985</p>	
<p>Trag-/Führungsgelenk / Support-/ Steering Link</p>	<p> A17</p>	<p>10160 171 407 365 F</p> 
<p>2.5, 118 kW 08.87 - 12.90</p>	<p>->01.1985</p>	
<p>2.5, 120 kW 06.81 - 07.87</p>		

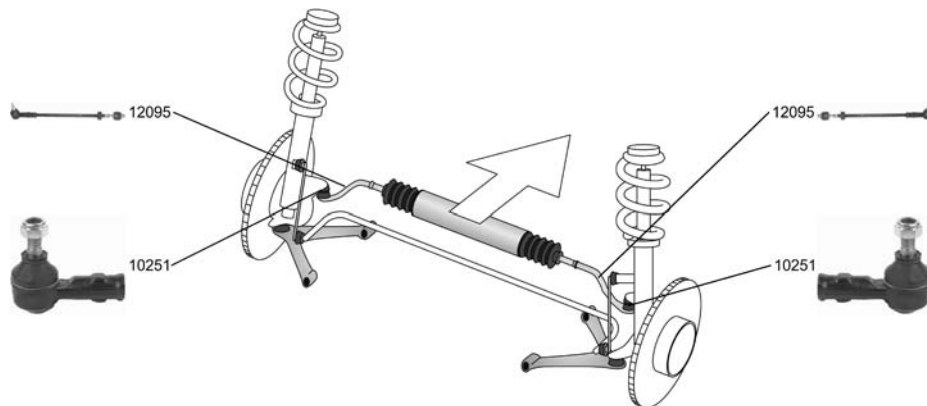
944 Cabrio/Convertible **12.88 - 07.91**







<p>Spurstange / Tie Rod, steering Aussengewinde [mm] / Outer Thread [mm]:M12x1,5 mit Zubehör / With accessories</p>	<p></p>	<p>12095 944 347 033 23</p> 
<p>ALL TYPES</p>		





OE

PORSCHE

944 Cabrio/Convertible 12.88 - 07.91



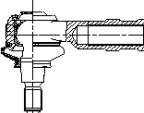

 Spurstangenkopf / Tie-rod End Konusmaß [mm] / Cone Size [mm]:14 Innengewinde [mm] / Inner Thread [mm]:M14x1,5 Gewindeart: mit Rechtsgewinde / Thread Type: with right-hand thread mit Zubehör / With accessories Gewindemaß / Thread Size:M14x1,5		10251 477 419 815 
ALL TYPES		

959 01.86 - 04.91

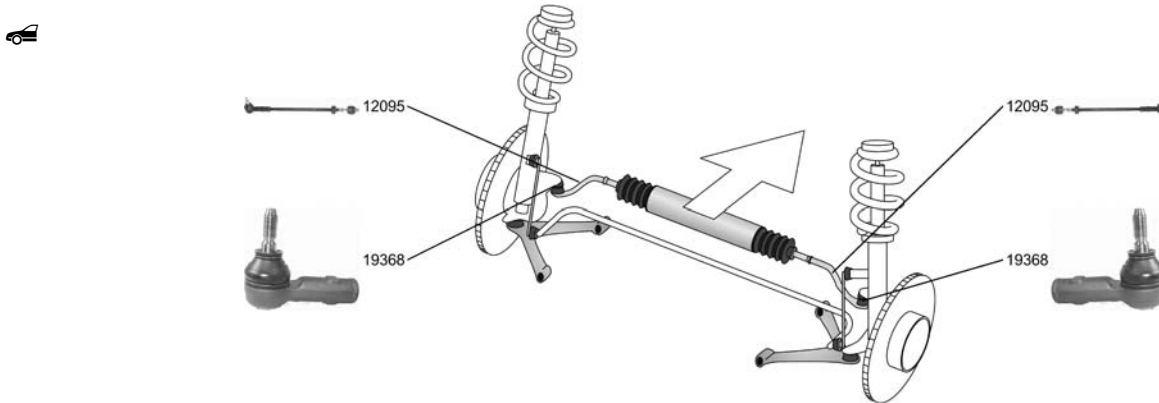
 Spurstangenkopf / Tie-rod End Gewindeart: mit Rechtsgewinde / Thread Type: with right-hand thread Innengewinde [mm] / Inner Thread [mm]:M14x1,5		20357 930 347 322 00 
ALL TYPES		

968 06.91 - 11.95



Spurstange / Tie Rod, steering Aussengewinde [mm] / Outer Thread [mm]:M12x1,5 mit Zubehör / With accessories		12095 944 347 033 23 
Spurstangenkopf / Tie-rod End Gewindeart: mit Rechtsgewinde / Thread Type: with right-hand thread Innengewinde [mm] / Inner Thread [mm]:M14x1,5		19368 944 347 333 04 
ALL TYPES		





PORSCHE

968 Cabrio/Convertible

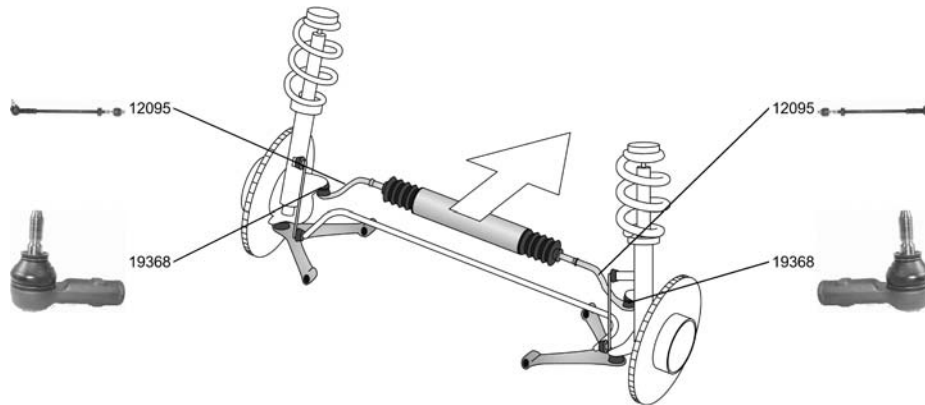
06.91 - 11.95



Spurstange / Tie Rod, steering Aussengewinde [mm] / Outer Thread [mm]:M12x1,5 mit Zubehör / With accessories ALL TYPES		12095 944 347 033 23 
Spurstangenkopf / Tie-rod End Gewindeart: mit Rechtsgewinde / Thread Type: with right-hand thread Innengewinde [mm] / Inner Thread [mm]:M14x1,5 ALL TYPES		19368 944 347 333 04 

BOXSTER (986)

09.96 -



Spurstangenkopf / Tie-rod End ALL TYPES		29646 996 347 131 04 
---	--	--

CAYENNE (955)

09.02 -

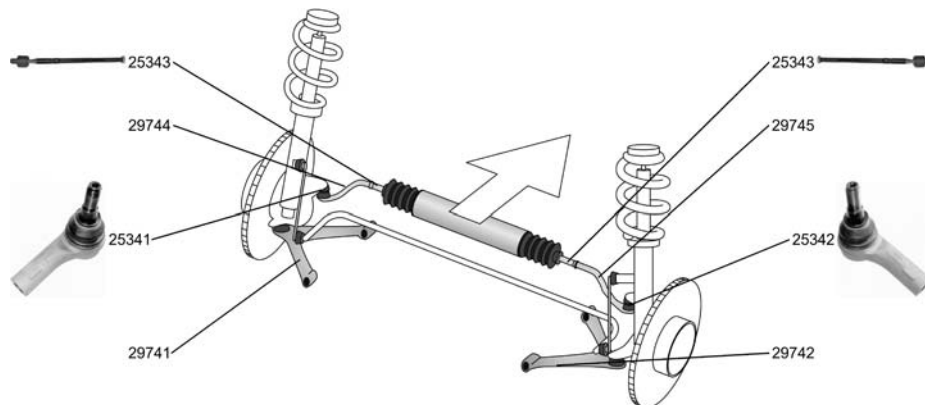

Spurstange / Tie Rod, steering 3.2 10.03 - S 4.5 09.02 - Turbo 4.5 09.02 -		29744 955 347 031 021 25343 25341
Spurstange / Tie Rod, steering 3.2 10.03 - S 4.5 09.02 - Turbo 4.5 09.02 -		29745 955 347 032 021 25343 25342
Spurstangenkopf / Tie-rod End 3.2 10.03 - S 4.5 09.02 - Turbo 4.5 09.02 - Turbo S 4.5, 368 kW 01.04 -		25341 955 347 131 21 

















OE

PORSCHE













CAYENNE (955)

09.02 -

 Spurstangenkopf / Tie-rod End 3.2 S 4.5 Turbo 4.5 Turbo S 4.5, 368 kW	10.03 -		25342 955 347 132 21 
	09.02 - 09.02 - 01.04 -		
Axialgelenk, Spurstange / Axial Rod, tie rod 3.2 S 4.5 Turbo 4.5 Turbo S 4.5, 368 kW	10.03 -		25343 
	09.02 - 09.02 - 01.04 -		
Lenker, Radaufhängung / Track Control Arm 3.2 S 4.5 Turbo 4.5	10.03 -		29740 955 341 027 01
	09.02 - 09.02 -		
Lenker, Radaufhängung / Track Control Arm 3.2 S 4.5 Turbo 4.5	10.03 -		29741 955 341 017 30
	09.02 - 09.02 -		
Lenker, Radaufhängung / Track Control Arm 3.2 S 4.5 Turbo 4.5	10.03 -		29742 955 341 018 30
	09.02 - 09.02 -		
Stange/Strebe, Stabilisator / Rod/Strut, stabiliser Pendelstange / Suspension Rod	10.03 -		30583 955 343 069 00
	09.02 - 09.02 - 01.04 -		
 Stange/Strebe, Stabilisator / Rod/Strut, stabiliser Pendelstange / Suspension Rod mit Zubehör / With accessories	10.03 -		26050 955 333 069 11 
	09.02 - 09.02 - 01.04 -		
Stange/Strebe, Stabilisator / Rod/Strut, stabiliser Pendelstange / Suspension Rod mit Zubehör / With accessories	10.03 -		26051 955 333 070 11 
	09.02 - 09.02 - 01.04 -		

Arithmetische Liste / Part number list

Artikelnummer Article No.	Seite Page	Hersteller Manufacturer	Artikelnummer Article No.	Seite Page	Hersteller Manufacturer
10160 ▾⊕	8 10	PORSCHE	19919 ⊕♂	3	PORSCHE
Trag-/Führungsgelenk / Support-/ Steering Link			Spurstangenkopf / Tie-rod End		
10165 ▾⊕	8 10	PORSCHE	19921 ⊕♂	3 4	PORSCHE
Lenker, Radaufhängung / Track Control Arm			Spurstangenkopf / Tie-rod End		
10251 ⊕♂	7 10 11	PORSCHE	20355 ⊕♂	9	PORSCHE
Spurstangenkopf / Tie-rod End			Spurstangenkopf / Tie-rod End		
12088 ▾⊕	1 2	PORSCHE	20356 ⊕	2	PORSCHE
Trag-/Führungsgelenk / Support-/ Steering Link			Stange/Strebe, Stabilisator / Rod/Strut, stabiliser		
12089 ▾⊕	9	PORSCHE	20357 ⊕♂	1 11	PORSCHE
Trag-/Führungsgelenk / Support-/ Steering Link			Spurstangenkopf / Tie-rod End		
12091 ⊕♂	8	PORSCHE	20361 ▾⊕	3 4	PORSCHE
Spurstange / Tie Rod, steering			Trag-/Führungsgelenk / Support-/ Steering Link		
12092 ⊕♂	1	PORSCHE	20362 ⊕♂	4 5	PORSCHE
Spurstange / Tie Rod, steering			Axialgelenk, Spurstange / Axial Rod, tie rod		
12093 ⊕♂	7 8 9	PORSCHE	25167 ⊕	2	PORSCHE
Spurstange / Tie Rod, steering			Stabilisatorlager / Mounting, Stabilizer		
12094 ⊕♂	9	PORSCHE	25341	12 12	PORSCHE
Spurstange / Tie Rod, steering			Spurstangenkopf / Tie-rod End		
12095 ⊕♂	9 10 11	PORSCHE	25342 ⊕	13	PORSCHE
Spurstange / Tie Rod, steering	12		Spurstangenkopf / Tie-rod End		
13779 ▲	8	PORSCHE	25343 ⊕	13	PORSCHE
Trag-/Führungsgelenk / Support-/ Steering Link			Axialgelenk, Spurstange / Axial Rod, tie rod		
15626 ⊕♂	8 9 10	PORSCHE	26049 ⊕	4 5 6	PORSCHE
Spurstangenkopf / Tie-rod End			Stange/Strebe, Stabilisator / Rod/Strut, stabiliser		
17385 ⊕♂	1 2	PORSCHE	26050 ⊕	13	PORSCHE
Spurstangenkopf / Tie-rod End			Stange/Strebe, Stabilisator / Rod/Strut, stabiliser		
19335 ⊕♂	8	PORSCHE	26051 ⊕	13	PORSCHE
Spurstange / Tie Rod, steering			Stange/Strebe, Stabilisator / Rod/Strut, stabiliser		
19336 ⊕	1	PORSCHE	27737 ⊕	6	PORSCHE
Stange/Strebe, Stabilisator / Rod/Strut, stabiliser			Stange/Strebe, Stabilisator / Rod/Strut, stabiliser		
19340 ▾⊕	4 5	PORSCHE	27738 ⊕	6	PORSCHE
Trag-/Führungsgelenk / Support-/ Steering Link			Stange/Strebe, Stabilisator / Rod/Strut, stabiliser		
19368 ⊕♂	10 11 12	PORSCHE	27739 ⊕	7	PORSCHE
Spurstangenkopf / Tie-rod End			Stange/Strebe, Stabilisator / Rod/Strut, stabiliser		
19907 ▲⊕	9	PORSCHE	27740 ⊕	7	PORSCHE
Stange/Strebe, Stabilisator / Rod/Strut, stabiliser			Stange/Strebe, Stabilisator / Rod/Strut, stabiliser		
19917 ▲⊕♂	4 5	PORSCHE	29644 ⊕	7	PORSCHE
Spurstange / Tie Rod, steering			Stange/Strebe, Stabilisator / Rod/Strut, stabiliser		
19918 ⊕♂	3	PORSCHE			
Spurstangenkopf / Tie-rod End					

Artikelnummer Article No.	Seite Page	Hersteller Manufacturer	Artikelnummer Article No.	Seite Page	Hersteller Manufacturer
29645 	7	PORSCHE			
Stange/Strebe, Stabilisator / Rod/Strut, stabiliser					
29646 	6 7 12	PORSCHE			
Spurstangenkopf / Tie-rod End					
29740  	13	PORSCHE			
Lenker, Radaufhängung / Track Control Arm					
29741  	13	PORSCHE			
Lenker, Radaufhängung / Track Control Arm					
29742  	13	PORSCHE			
Lenker, Radaufhängung / Track Control Arm					
29744 	12	PORSCHE			
Spurstange / Tie Rod, steering					
29745 	12	PORSCHE			
Spurstange / Tie Rod, steering					
30583  	13	PORSCHE			
Stange/Strebe, Stabilisator / Rod/Strut, stabiliser					



Vergleichsliste / Cross reference list

Vergleichs-Nr. Compare No.	Artikelnummer Article No.	Vergleichs-Nr. Compare No.	Artikelnummer Article No.	Vergleichs-Nr. Compare No.	Artikelnummer Article No.
PORSCHE					
	171 407 153 D		10165		
	171 407 365 C		13779		
	171 407 365 F		10160		
	477 419 815		10251		
	901 343 782 00		25167		
	911 341 049 01		12088		
	911 347 322 04		17385		
	928 341 049 12		12089		
	928 343 069 01		19907		
	928 347 031 01		12091		
	928 347 031 07		19335		
	928 347 322 02		20355		
	930 333 071 00		20356		
	930 333 072 00		19336		
	930 347 031 01		12092		
	930 347 322 00		20357		
	944 347 033 01		12093		
	944 347 033 20		12094		
	944 347 033 23		12095		
	944 347 333 01		15626		
	944 347 333 04		19368		
	955 333 069 11		26050		
	955 333 070 11		26051		
	955 341 017 30		29741		
	955 341 018 30		29742		
	955 341 027 01		29740		
	955 343 069 00		30583		
	955 347 031 021		29744		
	955 347 032 021		29745		
	955 347 131 21		25341		
	955 347 131 21		25341		
	955 347 132 21		25342		
	964 341 049 03		20361		
	964 347 032 00		19918		
	964 347 322 02		19921		
	965 347 032 00		19919		
	993 333 073 80		26049		
	993 341 049 02		19340		
	993 347 038 81		19917		
	993 347 131 01		20362		
	996 347 131 04		29646		
	997 333 069 04		27739		
	997 333 070 04		27740		
	997 343 069 00		27737		
	997 343 070 00		27738		
	997 343 073 02		29644		
	997 343 074 02		29645		

Neuaufnahmen / New to range

Artikelnummer Article No.	Seite Page	Hersteller Manufacturer	Artikelnummer Article No.	Seite Page	Hersteller Manufacturer
10160	8 10	PORSCHE	27739	7	PORSCHE
20362	4 5	PORSCHE	27740	7	PORSCHE
25167	2	PORSCHE	29644	7	PORSCHE
25343	13	PORSCHE	29645	7	PORSCHE
26049	4 5 6	PORSCHE	29646	6 7 12	PORSCHE
26050	13	PORSCHE	29740	13	PORSCHE
26051	13	PORSCHE	29741	13	PORSCHE
27737	6	PORSCHE	29742	13	PORSCHE
27738	6	PORSCHE	29744	12	PORSCHE

Neuaufnahmen / New to range

Artikelnummer Article No.	Seite Page	Hersteller Manufacturer
29745 	12	PORSCHE
30583  	13	PORSCHE

Artikelnummer Article No.	Seite Page	Hersteller Manufacturer
------------------------------	---------------	----------------------------

Geänderte Bestellnummer / Amended part numbers

Artikelnummer alt Article No. old	Artikelnummer neu Article No. new	Artikelnummer alt Article No. old	Artikelnummer neu Article No. new	Artikelnummer alt Article No. old	Artikelnummer neu Article No. new
25330	25341				
25330	25341				

Geänderte Bestellnummer / Amended part numbers

Artikelnummer neu Article No. new	Artikelnummer alt Article No. old	Artikelnummer neu Article No. new	Artikelnummer alt Article No. old	Artikelnummer neu Article No. new	Artikelnummer alt Article No. old
25341	25330				
25341	25330				