











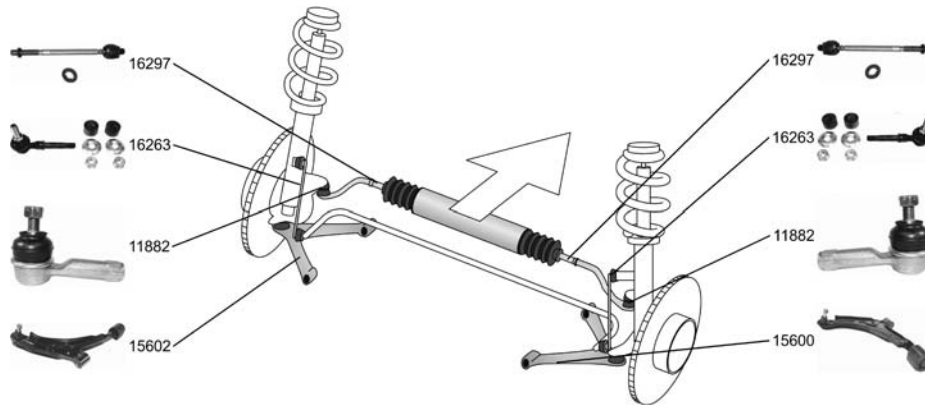



OE

NISSAN

100 NX (B13)

03.90 - 10.94





<p>Spurstangenkopf / Tie-rod End Gewindeart: mit Rechtsgewinde / Thread Type: with right-hand thread Innengewinde [mm] / Inner Thread [mm]: M12x1,25</p>		<p>11882 48520-02E26</p>
<p>ALL TYPES</p>		
<p>Axialgelenk, Spurstange / Axial Rod, tie rod</p>		<p>16297 48521-50Y25</p>
<p>ALL TYPES</p>		
<p>Lenker, Radaufhängung / Track Control Arm</p>		<p>15600 54500-52Y10</p>
<p>ALL TYPES</p>		
<p>Lenker, Radaufhängung / Track Control Arm</p>		<p>15602 54501-52Y10</p>
<p>ALL TYPES</p>		
<p>Stange/Strebe, Stabilisator / Rod/Strut, stabiliser Pendelstange / Suspension Rod</p>		<p>16263 54618-50Y00</p>
<p>ALL TYPES</p>		

200 SX (S13)

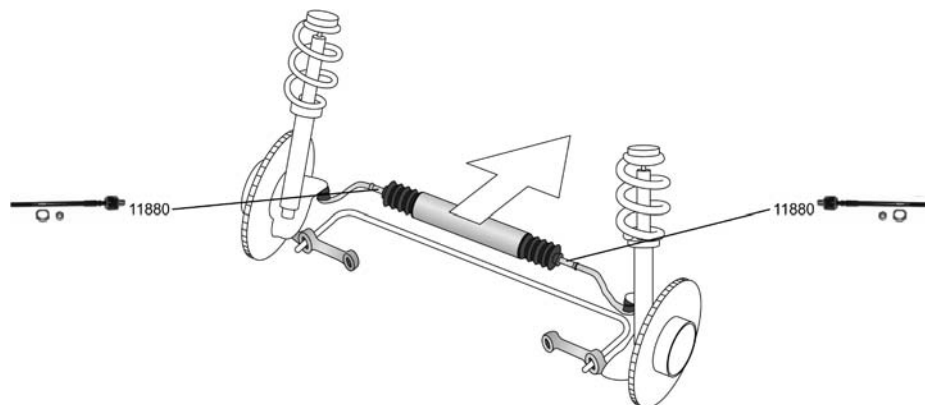
07.88 - 11.94





<p>Axialgelenk, Spurstange / Axial Rod, tie rod Gewindeart: mit Rechtsgewinde / Thread Type: with right-hand thread Gewindemaß / Thread Size: M12x1,25</p>		<p>11880 48521-70A06</p>
<p>ALL TYPES</p>		



NISSAN



200 SX (S13)

07.88 - 11.94

 Faltenbalgsatz, Lenkung / Bellow Kit, steering system ALL TYPES		30174 48203-10V25 
---	---	---

300 ZX (Z31)







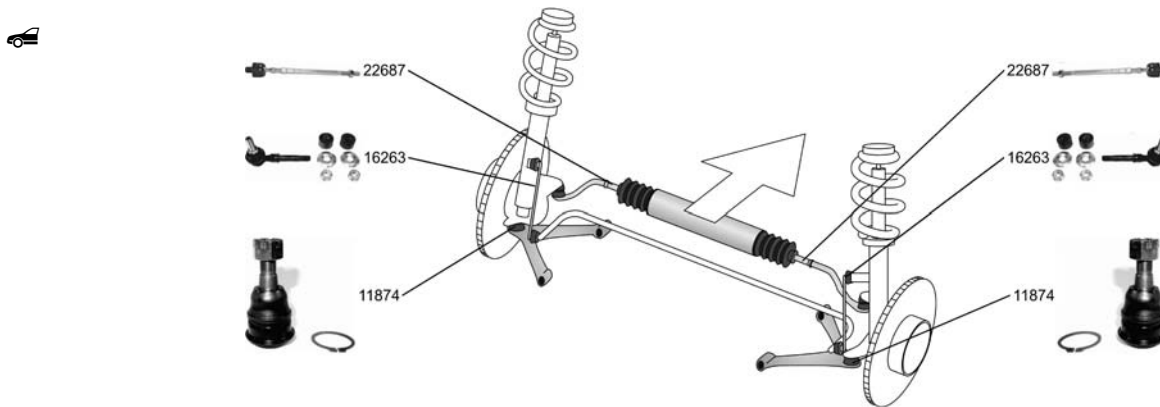

01.84 - 10.90

 Axialgelenk, Spurstange / Axial Rod, tie rod Gewindemaß / Thread Size: M14x1,5 Gewindeart: mit Rechtsgewinde / Thread Type: with right-hand thread ALL TYPES		15592 48521-01F00 
--	---	---

ALMERA I (N15)

07.95 - 07.00



Axialgelenk, Spurstange / Axial Rod, tie rod ALL TYPES		22687 48521-1M226 
Trag-/Führungsgelenk / Support-/ Steering Link ALL TYPES		11874 40160-69Y10 
Stange/Strebe, Stabilisator / Rod/Strut, stabiliser Pendelstange / Suspension Rod ALL TYPES		16263 54618-50Y00 
Faltenbalgsatz, Lenkung / Bellow Kit, steering system ALL TYPES		30199 48203-0E025 
Faltenbalgsatz, Lenkung / Bellow Kit, steering system ALL TYPES		30200 48203-41B27











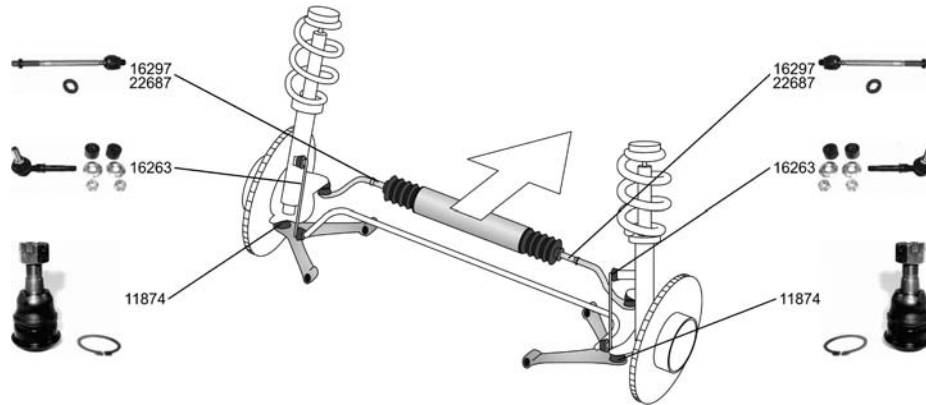



OE

NISSAN

**ALMERA I Hatchback/avec hayon
(N15)**

07.95 - 03.00



<p>Axialgelenk, Spurstange / Axial Rod, tie rod</p> <p>1.4 S,GX,LX 1.4 1.6 SR,SLX 1.6</p>	<p>09.95 - 03.00 09.95 - 03.00 09.95 - 03.00 09.95 - 03.00</p>	<p></p>	<p>16297 48521-50Y25</p> 
<p>Axialgelenk, Spurstange / Axial Rod, tie rod</p> <p>ALL TYPES</p>		<p></p>	<p>22687 48521-1M226</p> 
<p>Trag-/Führungsgelenk / Support-/ Steering Link</p> <p>ALL TYPES</p>		<p></p>	<p>11874 40160-69Y10</p> 
<p>Stange/Strebe, Stabilisator / Rod/Strut, stabiliser</p> <p>Pendelstange / Suspension Rod</p> <p>ALL TYPES</p>		<p></p>	<p>16263 54618-50Y00</p> 
<p>Faltenbalgsatz, Lenkung / Bellow Kit, steering system</p> <p>ALL TYPES</p>		<p></p>	<p>30199 48203-0E025</p> 
<p>Faltenbalgsatz, Lenkung / Bellow Kit, steering system</p> <p>ALL TYPES</p>		<p></p>	<p>30200 48203-41B27</p>









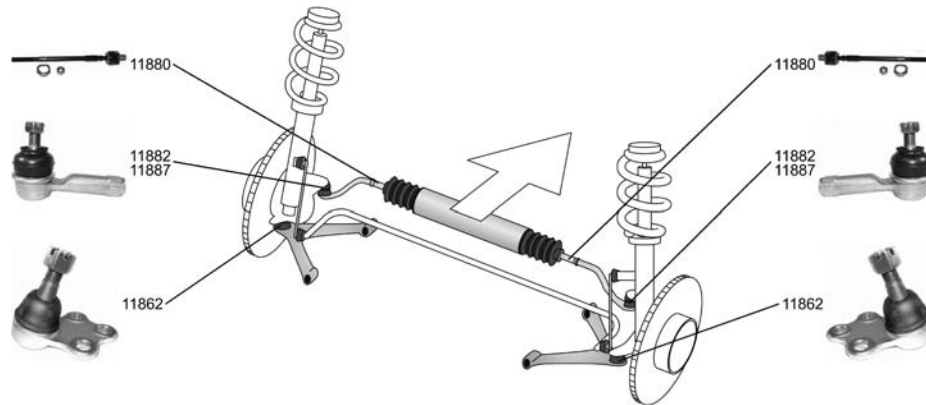







NISSAN

BLUEBIRD (U11)

11.83 - 05.90





<p>Spurstangenkopf / Tie-rod End Gewindeart: mit Rechtsgewinde / Thread Type: with right-hand thread Innengewinde [mm] / Inner Thread [mm]: M12x1,25</p> <p>1.8 11.83 - 06.88 2.0 i 04.84 - 01.88 2.0 D 04.84 - 01.88</p>		<p>11882 48520-02E26</p> 
<p>Spurstangenkopf / Tie-rod End Gewindeart: mit Rechtsgewinde / Thread Type: with right-hand thread Gewindemaß / Thread Size: M12x1,25 Innengewinde [mm] / Inner Thread [mm]: M12x1,25</p> <p>1.8 11.83 - 06.88 1.8 Turbo, 99 kW 04.84 - 05.90 2.0 i 04.84 - 01.88 2.0 D 04.84 - 01.88</p>		<p>11887 48520-50A26</p> 
<p>Axialgelenk, Spurstange / Axial Rod, tie rod Gewindeart: mit Rechtsgewinde / Thread Type: with right-hand thread Gewindemaß / Thread Size: M12x1,25</p> <p>1.8 11.83 - 06.88 1.8 Turbo, 99 kW 04.84 - 05.90 2.0 i 04.84 - 01.88</p>	 <p>->10.1985</p>	<p>11880 48521-70A06</p> 
<p>Trag-/Führungsgelenk / Support-/ Steering Link ohne Zubehör / without accessories</p> <p>1.8 11.83 - 06.88 1.8 Turbo, 99 kW 04.84 - 05.90 2.0 i 04.84 - 01.88 2.0 D 04.84 - 01.88</p>		<p>11862 40160-85E00</p> 
<p>Faltenbalgsatz, Lenkung / Bellow Kit, steering system</p> <p>1.8 11.83 - 06.88 1.8 Turbo, 99 kW 04.84 - 05.90 2.0 i 04.84 - 01.88 2.0 D 04.84 - 01.88</p>		<p>30109 48204-04A01</p> 
<p>Faltenbalgsatz, Lenkung / Bellow Kit, steering system</p> <p>2.0 i 04.84 - 01.88</p> <p>2.0 D 04.84 - 01.88</p> <p>1.8 11.83 - 06.88</p>	 <p>->02.1986</p> <p>->09.1987</p>	<p>30145 48203-05F26</p> 
<p>Faltenbalgsatz, Lenkung / Bellow Kit, steering system</p> <p>1.8 11.83 - 06.88</p>	 <p>04.1984 - 02.1986</p>	<p>30146 48204-42L25</p> 











OE

NISSAN



BLUEBIRD (U11) 11.83 - 05.90

	Faltenbalgsatz, Lenkung / Bellow Kit, steering system		30174 48203-10V25
	2.0 i 04.84 - 01.88 2.0 D 04.84 - 01.88	10.1987->	

BLUEBIRD Station Wagon/Estate/Break (WU11) 11.83 - 09.90

	Spurstangenkopf / Tie-rod End Gewindeart: mit Rechtsgewinde / Thread Type: with right-hand thread Innengewinde [mm] / Inner Thread [mm]: M12x1,25		11882 48520-02E26	
	2.0, 75 kW 04.86 - 09.90 2.0 i, 77 kW 04.84 - 12.90 2.0 D, 43 kW 04.84 - 01.88 2.0 D, 49 kW 03.86 - 12.90			
Spurstangenkopf / Tie-rod End Gewindeart: mit Rechtsgewinde / Thread Type: with right-hand thread Gewindemaß / Thread Size: M12x1,25 Innengewinde [mm] / Inner Thread [mm]: M12x1,25			11887 48520-50A26	
				2.0, 75 kW 04.86 - 09.90 2.0 i 04.84 - 12.90 2.0 D, 43 kW 04.84 - 01.88 2.0 D, 49 kW 03.86 - 12.90
Axialgelenk, Spurstange / Axial Rod, tie rod Gewindeart: mit Rechtsgewinde / Thread Type: with right-hand thread Gewindemaß / Thread Size: M12x1,25			11880 48521-70A06	
				2.0 i, 77 kW 04.84 - 12.90 2.0 D, 43 kW 04.84 - 01.88
Trag-/Führungsgelenk / Support-/ Steering Link ohne Zubehör / without accessories			11862 40160-85E00	
				2.0, 75 kW 04.86 - 09.90 2.0 i 04.84 - 12.90 2.0 D, 43 kW 04.84 - 01.88 2.0 D, 49 kW 03.86 - 12.90
Faltenbalgsatz, Lenkung / Bellow Kit, steering system			30109 48204-04A01	
				2.0, 75 kW 04.86 - 09.90 2.0 i 04.84 - 12.90 2.0 D, 43 kW 04.84 - 01.88 2.0 D, 49 kW 03.86 - 12.90
Faltenbalgsatz, Lenkung / Bellow Kit, steering system			30145 48203-05F26	
				2.0, 75 kW 04.86 - 09.90
				2.0 D, 43 kW 04.84 - 01.88
Faltenbalgsatz, Lenkung / Bellow Kit, steering system			30174 48203-10V25	
				2.0, 75 kW 04.86 - 09.90
				2.0 i, 85 kW 09.88 - 09.90
				2.0 D, 43 kW 04.84 - 01.88 2.0 D, 49 kW 03.86 - 12.90

BLUEBIRD (T72 , T12) 12.85 - 09.90









	Spurstangenkopf / Tie-rod End Gewindeart: mit Rechtsgewinde / Thread Type: with right-hand thread Innengewinde [mm] / Inner Thread [mm]: M12x1,25		11882 48520-02E26
	2.0 (T12) 12.85 - 12.87 1.6 03.86 - 06.90 2.0 i (HLT72, T12) 12.85 - 12.90 2.0 D (SLT72, T12) 03.86 - 12.90	->08.1987	



NISSAN





BLUEBIRD (T72 , T12)

12.85 - 09.90

 Spurstangenkopf / Tie-rod End Gewindeart: mit Rechtsgewinde / Thread Type: with right-hand thread Gewindemaß / Thread Size: M12x1,25 Innengewinde [mm] / Inner Thread [mm]: M12x1,25		11887 48520-50A26 
1.6 03.86 - 06.90 1.8 i 16V (RLT72) 02.89 - 12.90 2.0 (T12) 12.85 - 12.87 2.0 i (HLT72, T12) 12.85 - 12.90 2.0 i 09.88 - 09.90 2.0 D (SLT72, T12) 03.86 - 12.90		
Axialgelenk, Spurstange / Axial Rod, tie rod Gewindeart: mit Rechtsgewinde / Thread Type: with right-hand thread Gewindemaß / Thread Size: M12x1,25		11880 48521-70A06 
1.6 03.86 - 06.90 1.8 i 16V (RLT72) 02.89 - 12.90 2.0 (T12) 12.85 - 12.87 2.0 i (HLT72, T12) 12.85 - 12.90 2.0 i 09.88 - 09.90 2.0 D (SLT72, T12) 03.86 - 12.90		
Trag-/Führungsgelenk / Support-/ Steering Link ohne Zubehör / without accessories		11862 40160-85E00 
1.6 03.86 - 06.90 1.8 i 16V (RLT72) 02.89 - 12.90 2.0 (T12) 12.85 - 12.87 2.0 i (HLT72, T12) 12.85 - 12.90 2.0 i 09.88 - 09.90 2.0 D (SLT72, T12) 03.86 - 12.90		
Faltenbalgsatz, Lenkung / Bellow Kit, steering system		30145 48203-05F26 
2.0 (T12) 12.85 - 12.87 2.0 i (HLT72, T12) 12.85 - 12.90		
2.0 D (SLT72, T12) 03.86 - 12.90	 ->09.1987	
1.6 03.86 - 06.90	 ->10.1987	
Faltenbalgsatz, Lenkung / Bellow Kit, steering system		30174 48203-10V25 
1.6 03.86 - 06.90 2.0 (T12) 12.85 - 12.87 2.0 i (HLT72, T12) 12.85 - 12.90 2.0 D (SLT72, T12) 03.86 - 12.90 1.8 i 16V (RLT72) 02.89 - 12.90 2.0 i 09.88 - 09.90	10.1987->	

BLUEBIRD Hatchback/avec hayon (T72, T12)

12.85 - 12.90

 Spurstangenkopf / Tie-rod End Gewindeart: mit Rechtsgewinde / Thread Type: with right-hand thread Innengewinde [mm] / Inner Thread [mm]: M12x1,25		11882 48520-02E26 
2.0 (T12) 12.85 - 12.87 1.6 03.86 - 06.91 2.0 i (FHLT72, T12) 12.85 - 12.90 2.0 D (FSLT72, T12) 03.86 - 12.90	->08.1987	
Spurstangenkopf / Tie-rod End Gewindeart: mit Rechtsgewinde / Thread Type: with right-hand thread Gewindemaß / Thread Size: M12x1,25 Innengewinde [mm] / Inner Thread [mm]: M12x1,25		11887 48520-50A26 
1.6 03.86 - 06.91 1.8 i 16V (FRLT72) 02.89 - 12.90 1.8 Turbo 12.85 - 05.90 2.0 (T12) 12.85 - 12.87 2.0 i (FHLT72, T12) 12.85 - 12.90 2.0 i 09.88 - 09.90 2.0 D (FSLT72, T12) 03.86 - 12.90		











OE

NISSAN







BLUEBIRD Hatchback/avec hayon (T72, T12)

12.85 - 12.90

 Axialgelenk, Spurstange / Axial Rod, tie rod Gewindeart: mit Rechtsgewinde / Thread Type: with right-hand thread Gewindemaß / Thread Size: M12x1,25		11880 48521-70A06 
1.6 1.8 i 16V (FRLT72) 1.8 Turbo 2.0 (T12) 2.0 i (FHLT72, T12) 2.0 i 2.0 D (FSLT72, T12)	03.86 - 06.91 02.89 - 12.90 12.85 - 05.90 12.85 - 12.87 12.85 - 12.90 09.88 - 09.90 03.86 - 12.90	
Trag-/Führungsgelenk / Support-/ Steering Link ohne Zubehör / without accessories		11862 40160-85E00 
1.6 1.8 i 16V (FRLT72) 1.8 Turbo 2.0 (T12) 2.0 i (FHLT72, T12) 2.0 i 2.0 D (FSLT72, T12)	03.86 - 06.91 02.89 - 12.90 12.85 - 05.90 12.85 - 12.87 12.85 - 12.90 09.88 - 09.90 03.86 - 12.90	
Faltenbalgsatz, Lenkung / Bellow Kit, steering system		30145 48203-05F26 
2.0 (T12) 2.0 i (FHLT72, T12)	12.85 - 12.87 12.85 - 12.90	
2.0 D (FSLT72, T12)	03.86 - 12.90	
1.6	03.86 - 06.91	
Faltenbalgsatz, Lenkung / Bellow Kit, steering system		30174 48203-10V25 
1.8 i 16V (FRLT72) 2.0 i	02.89 - 12.90 09.88 - 09.90	
1.6 1.8 Turbo 2.0 (T12) 2.0 i (FHLT72, T12) 2.0 D (FSLT72, T12)	03.86 - 06.91 12.85 - 05.90 12.85 - 12.87 12.85 - 12.90 03.86 - 12.90	10.1987->

CHERRY (N12)

04.82 - 10.86

 Spurstange / Tie Rod, steering		15586 48510-70A27 
Axialgelenk, Spurstange / Axial Rod, tie rod Gewindeart: mit Rechtsgewinde / Thread Type: with right-hand thread Gewindemaß / Thread Size: M12x1,25		11880 48521-70A06 
1.0 1.3 1.5, 55 kW 1.5 Turbo 1.7 D	05.82 - 05.86 05.82 - 10.86 11.83 - 10.86 01.83 - 12.85 10.82 - 12.86	
Faltenbalgsatz, Lenkung / Bellow Kit, steering system		30109 48204-04A01 
1.0 1.3 1.5, 55 kW 1.5 Turbo 1.7 D	05.82 - 05.86 05.82 - 10.86 11.83 - 10.86 01.83 - 12.85 10.82 - 12.86	









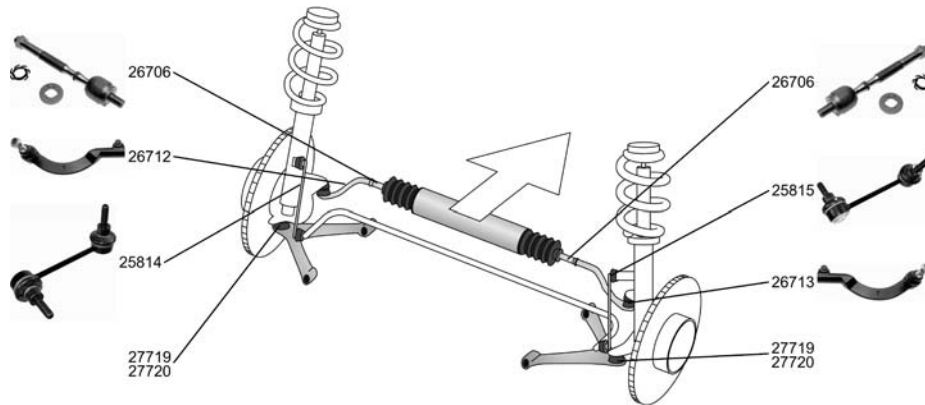





NISSAN

INTERSTAR Bus

07.02 -



<p>Spurstange / Tie Rod, steering ohne Zubehör / without accessories ALL TYPES</p>		<p>26712 48520-00QAH</p>
		
<p>Spurstangenkopf / Tie-rod End ohne Zubehör / without accessories ALL TYPES</p>		<p>26713 48520-00QAJ</p>
		
<p>Axialgelenk, Spurstange / Axial Rod, tie rod Gewindemaß / Thread Size: M14x1,5 Gewindemaß / Thread Size: M16x1,5 ohne Zubehör / without accessories ALL TYPES</p>		<p>26706 48521-00QAF</p>
		
<p>Trag-/Führungsgelenk / Support-/ Steering Link mit Zubehör / With accessories ALL TYPES</p>		<p>27719 40160-00QAB</p>
<p>Trag-/Führungsgelenk / Support-/ Steering Link mit Zubehör / With accessories ALL TYPES</p>		<p>27720 40160-000AD</p>
<p>Stange/Strebe, Stabilisator / Rod/Strut, stabiliser Pendelstange / Suspension Rod ohne Zubehör / without accessories ALL TYPES</p>		<p>25814 54616-00QAB</p>
		
<p>Stange/Strebe, Stabilisator / Rod/Strut, stabiliser Pendelstange / Suspension Rod ohne Zubehör / without accessories ALL TYPES</p>		<p>25815 54618-00QAA</p>
		











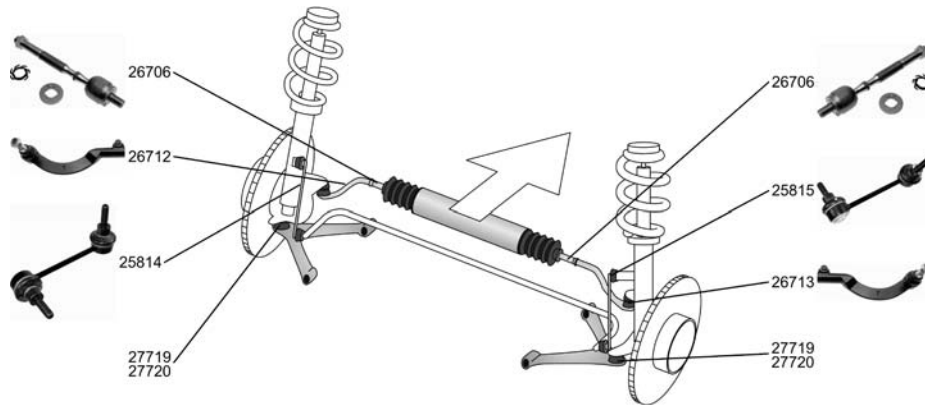



OE

NISSAN

INTERSTAR Kasten

07.02 -

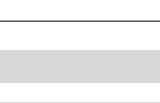

Spurstange / Tie Rod, steering ohne Zubehör / without accessories ALL TYPES		26712 48520-00QAH
		
Spurstangenkopf / Tie-rod End ohne Zubehör / without accessories ALL TYPES		26713 48520-00QAJ
		
Axialgelenk, Spurstange / Axial Rod, tie rod Gewindemaß / Thread Size: M14x1,5 Gewindemaß / Thread Size: M16x1,5 ohne Zubehör / without accessories ALL TYPES		26706 48521-00QAF
		
Trag-/Führungsgelenk / Support-/ Steering Link mit Zubehör / With accessories ALL TYPES		27719 40160-00QAB
Trag-/Führungsgelenk / Support-/ Steering Link mit Zubehör / With accessories ALL TYPES		27720 40160-000AD
Stange/Strebe, Stabilisator / Rod/Strut, stabiliser Pendelstange / Suspension Rod ohne Zubehör / without accessories ALL TYPES		25814 54616-00QAB
		
Stange/Strebe, Stabilisator / Rod/Strut, stabiliser Pendelstange / Suspension Rod ohne Zubehör / without accessories ALL TYPES		25815 54618-00QAA
		

LAUREL (JC31)

01.81 - 12.85



Faltenbalgsatz, Lenkung / Bellow Kit, steering system

2.4, 83 kW

01.81 - 01.84

30228











NISSAN

LAUREL (JC32)







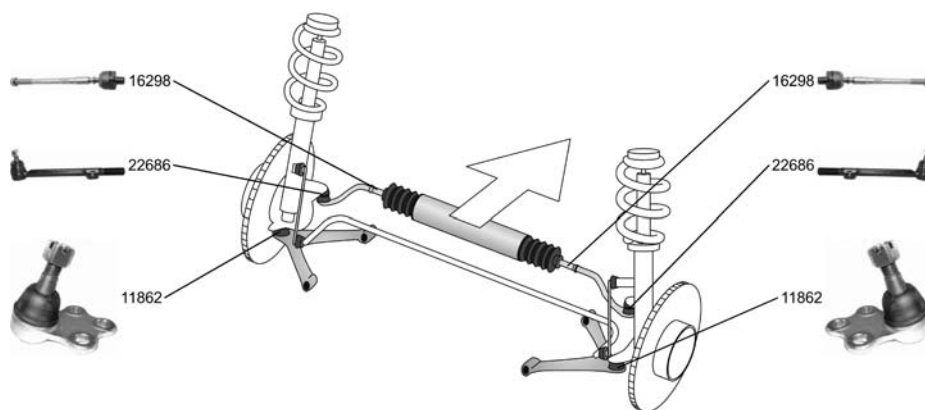

11.84 - 06.90

 Spurstangenkopf / Tie-rod End Gewindeart: mit Rechtsgewinde / Thread Type: with right-hand thread Innengewinde [mm] / Inner Thread [mm]: M14x1,5		11886 48520-41L27 
2.4 01.85 - 12.87 2.8 D 01.85 - 12.89		
Axialgelenk, Spurstange / Axial Rod, tie rod Gewindemaß / Thread Size: M14x1,5 Gewindeart: mit Rechtsgewinde / Thread Type: with right-hand thread		15592 48521-01F00 
2.4 01.85 - 12.87 2.8 D, 62 kW 01.85 - 12.87 2.8 D, 66 kW 01.85 - 12.89	->02.1987	
Trag-/Führungsgelenk / Support-/ Steering Link		15579 40160-67L00 
2.4 01.85 - 12.87 2.8 D 01.85 - 12.89		

MAXIMA (J30)

10.88 - 10.94



Spurstangenkopf / Tie-rod End ALL TYPES		22686 48520-88E25 
Axialgelenk, Spurstange / Axial Rod, tie rod radseitig / Wheel Side Aussengewinde [mm] / Outer Thread [mm]: M16x1 Aussengewinde [mm] / Outer Thread [mm]: M14x1,5 ALL TYPES		16298 48521-72E06 
ALL TYPES	->08.1991	
Trag-/Führungsgelenk / Support-/ Steering Link ohne Zubehör / without accessories ALL TYPES		11862 40160-85E00 
ALL TYPES		
Faltenbalgsatz, Lenkung / Bellow Kit, steering system ALL TYPES		30174 48203-10V25 
ALL TYPES		



OE

NISSAN

MAXIMA QX (A32)

10.94 - 08.00

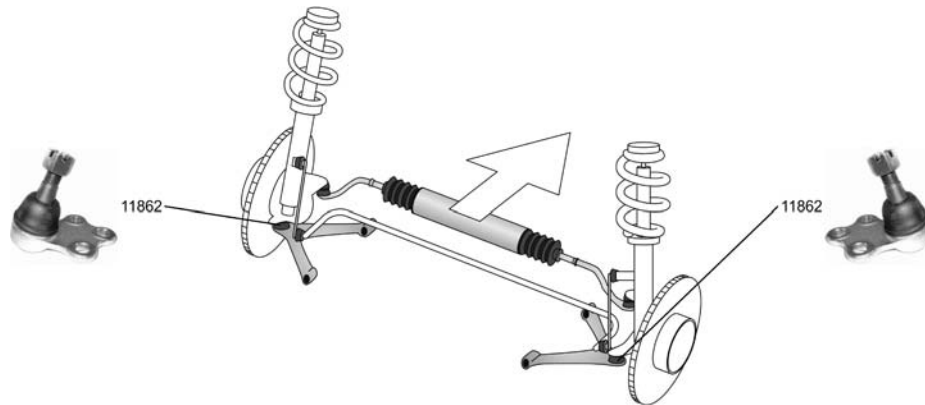

Trag-/Führungsgelenk / Support-/ Steering Link ohne Zubehör / without accessories ALL TYPES		11862 40160-85E00

MICRA (K10)

12.82 - 11.92

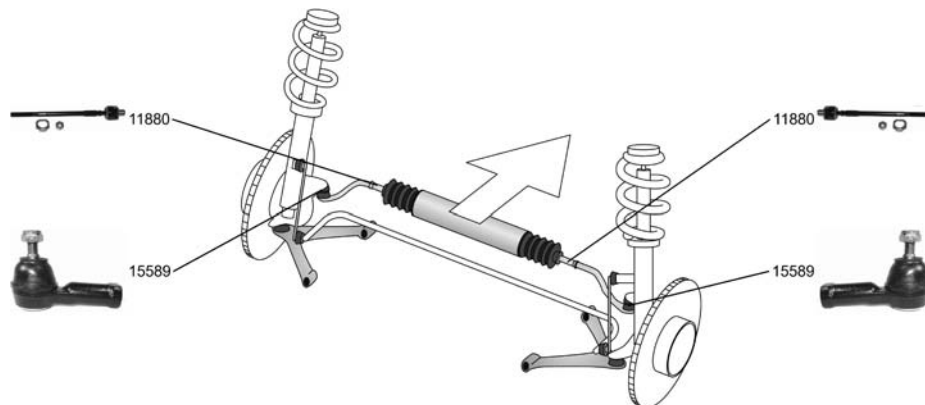

Spurstangenkopf / Tie-rod End Gewindeart: mit Rechtsgewinde / Thread Type: with right-hand thread Innengewinde [mm] / Inner Thread [mm]: M12x1,25 ALL TYPES ausser/except for : 1.0 Turbo (K10) 02.85 - 12.93 1.0, 37 kW 12.82 - 11.92		15589 48520-17B25
Axialgelenk, Spurstange / Axial Rod, tie rod Gewindeart: mit Rechtsgewinde / Thread Type: with right-hand thread Gewindemaß / Thread Size: M12x1,25 1.0, 37 kW 12.82 - 12.89 1.0, 40 kW 12.82 - 05.89 1.0, 43 kW 12.82 - 05.91 1.2 07.86 - 07.92	 02.1985->	11880 48521-70A06
Axialgelenk, Spurstange / Axial Rod, tie rod ALL TYPES ausser/except for : 1.0 Turbo (K10) 02.85 - 12.93 1.0, 37 kW 12.82 - 11.92		15591 48521-17B25
Faltenbalgsatz, Lenkung / Bellow Kit, steering system 1.0, 37 kW 12.82 - 12.89 1.0, 40 kW 12.82 - 05.89 1.0, 43 kW 12.82 - 05.91 1.2 07.86 - 07.92	 02.1985->	30109 48204-04A01





NISSAN

MICRA (K11)

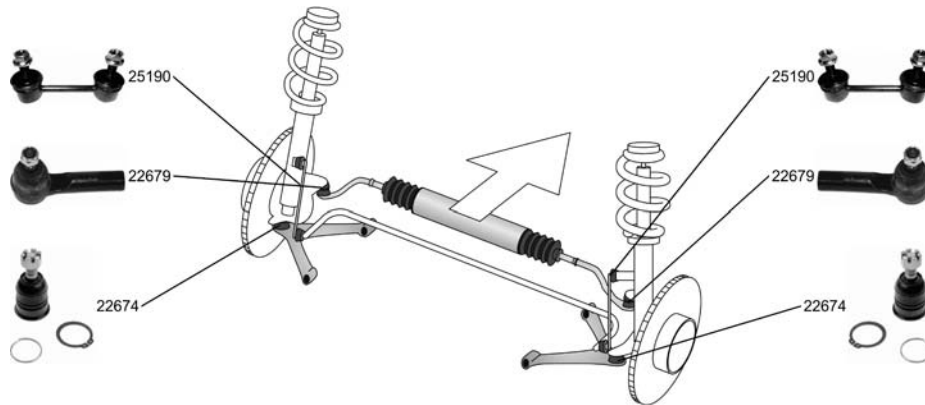
08.92 - 02.03



Spurstangenkopf / Tie-rod End ALL TYPES	▼↔	22679 48520-4F125	
Trag-/Führungsgelenk / Support-/ Steering Link 1.0 i 16V, 40 kW 08.92 - 09.00 1.3 i 16V 08.92 - 09.00 1.5 D 02.98 - 02.03	▼↔	22674 40160-4F100	
Stange/Strebe, Stabilisator / Rod/Strut, stabiliser Pendelstange / Suspension Rod ALL TYPES	↔	25190 56261-4F725	
Faltenbalgsatz, Lenkung / Bellow Kit, steering system ALL TYPES	↔	30246 48203-6F610	

MICRA (K12)

01.03 -

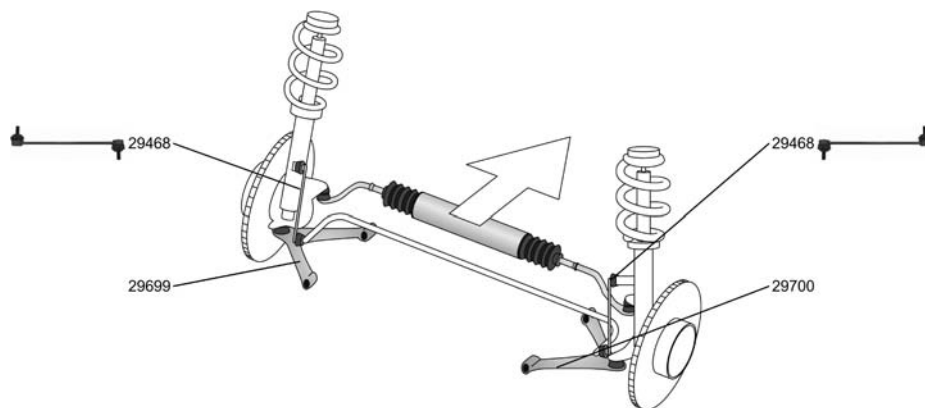





Lenker, Radaufhängung / Track Control Arm ALL TYPES ausser/except for : 160 SR 05.05 -	▼↔	29699 29469	
Lenker, Radaufhängung / Track Control Arm ALL TYPES ausser/except for : 160 SR 05.05 -	▼↔	29700 29469	
Lagerung, Lenker / Mounting, wishbone ALL TYPES ausser/except for : 160 SR 05.05 -	▼↔↑	29410 54560-AX600	







OE

NISSAN





MICRA (K12) 01.03 -

 Lagerung, Lenker / Mounting, wishbone ALL TYPES ausser/except for : 160 SR 05.05 -		29411 54570-AX600 
		29468 54618-AX600 
Stange/Strebe, Stabilisator / Rod/Strut, stabiliser Gewindemaß / Thread Size: M10x1,25 ALL TYPES ausser/except for : 1.0 16V 01.03 - 160 SR 05.05 -		





PATROL Station Wagon/closed off-road vehicle/carrosserie fermée (W160) 11.79 - 08.88

 Spurstangenkopf / Tie-rod End Gewindeart: mit Rechtsgewinde / Thread Type: with right-hand thread Gewindemaß / Thread Size: M22x1,5 3.2 TD (W160) 07.83 - 08.88 3.3 D (W160) 11.79 - 08.88		25200 48570-82100 
		25201 48580-82100 
Spurstangenkopf / Tie-rod End Gewindeart: mit Linksgewinde / Thread Type: With left-hand thread Gewindemaß / Thread Size: M22x1,5 3.2 TD (W160) 07.83 - 08.88 3.3 D (W160) 11.79 - 08.88		

PATROL Hardtop/closed off-road vehicle/carrosserie fermée (K160) 11.79 - 08.88

 Spurstangenkopf / Tie-rod End Gewindeart: mit Rechtsgewinde / Thread Type: with right-hand thread Gewindemaß / Thread Size: M22x1,5 ALL TYPES		25200 48570-82100 
		25201 48580-82100 
Spurstangenkopf / Tie-rod End Gewindeart: mit Linksgewinde / Thread Type: With left-hand thread Gewindemaß / Thread Size: M22x1,5 ALL TYPES		

PICK UP (720) 01.82 - 03.86

 Trag-/Führungsgelenk / Support-/ Steering Link 1.8 01.83 - 03.86 2.2 4WD 04.83 - 03.86 2.3 D 04.83 - 03.86 2.5 D 4WD 04.83 - 03.86		11860 40110-01G26 
		11873 40161-48W25 
Trag-/Führungsgelenk / Support-/ Steering Link 1.8 01.83 - 03.86 2.3 D 04.83 - 03.86		









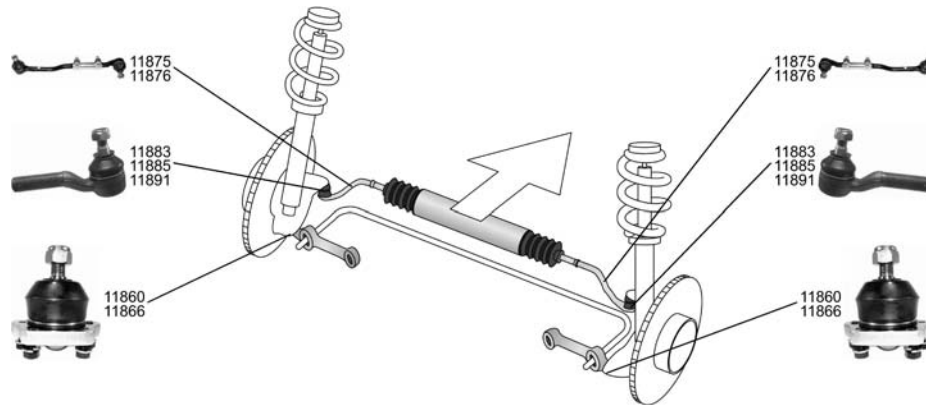





NISSAN

PICK UP (D21)

09.85 - 02.98



Spurstange / Tie Rod, steering 2.4 i 12V 2.5 D, 61 kW	04.92 - 02.98 03.96 - 02.98		11875 48510-01G25 
Spurstange / Tie Rod, steering 2.4 i 4WD 2.4 i 12V 4WD 2.5 D 4WD, 55 kW 2.5 D 4WD, 59 kW 2.5 D 4WD, 61 kW	03.86 - 04.92 04.92 - 02.98 03.86 - 08.91 08.87 - 02.98 03.96 - 02.98	 	11876 48510-31G25 
Spurstangenkopf / Tie-rod End Gewindeart: mit Linksgewinde / Thread Type: With left-hand thread Gewindemaß / Thread Size: M18x1,5 2.4 i 12V 2.5 D, 61 kW	04.92 - 02.98 03.96 - 02.98		11883 48520-01G25 
Spurstangenkopf / Tie-rod End Gewindeart: mit Rechtsgewinde / Thread Type: with right-hand thread Aussengewinde [mm] / Outer Thread [mm]: M16x1,5 2.4 i 4WD 2.4 i 12V 2.4 i 12V 4WD 3.0 i V6 4WD 2.5 D 4WD, 55 kW 2.5 D 4WD, 59 kW 2.5 D, 61 kW 2.5 D 4WD, 61 kW 2.7 D 4WD, 73 kW	03.86 - 04.92 04.92 - 02.98 04.92 - 02.98 09.90 - 02.98 03.86 - 08.91 08.87 - 02.98 03.96 - 02.98 03.96 - 02.98 08.87 - 02.98		11885 48520-61G25 
Spurstangenkopf / Tie-rod End Gewindeart: mit Rechtsgewinde / Thread Type: with right-hand thread Aussengewinde [mm] / Outer Thread [mm]: M16x1,5 2.4 i 4WD 3.0 i V6 4WD 2.5 D 4WD, 55 kW 2.5 D 4WD, 59 kW 2.7 D 4WD, 73 kW	03.86 - 04.92 09.90 - 02.98 03.86 - 08.91 08.87 - 02.98 08.87 - 02.98		11891 48570-61G25 
Trag-/Führungsgelenk / Support-/ Steering Link 2.4 i 4WD 2.4 i 12V 2.4 i 12V 4WD 3.0 i V6 4WD 2.5 D 4WD, 55 kW 2.5 D 4WD, 59 kW 2.5 D, 61 kW 2.5 D 4WD, 61 kW 2.7 D 4WD, 73 kW	03.86 - 04.92 04.92 - 02.98 04.92 - 02.98 09.90 - 02.98 03.86 - 08.91 08.87 - 02.98 03.96 - 02.98 03.96 - 02.98 08.87 - 02.98		11860 40110-01G26 







OE

NISSAN

PICK UP (D21)









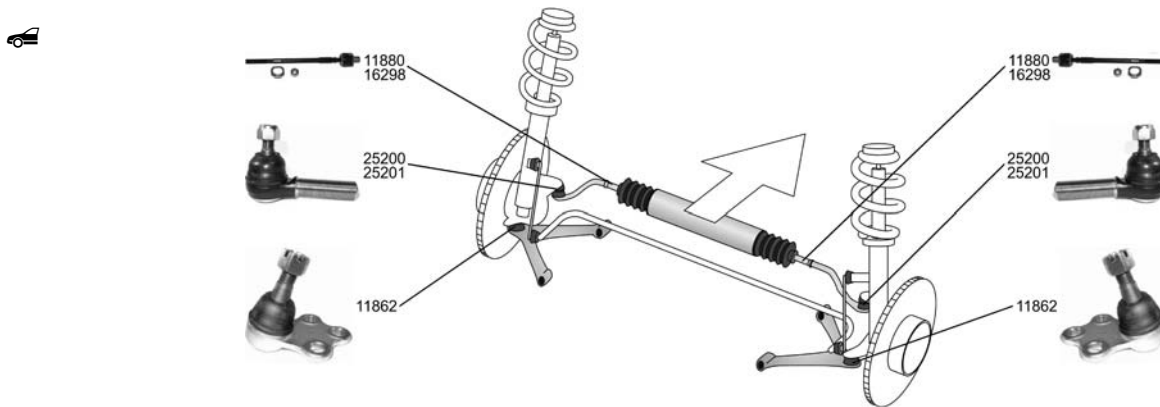

09.85 - 02.98

 Trag-/Führungsgelenk / Support-/ Steering Link 2.4 i 4WD 2.4 i 12V 2.4 i 12V 4WD 3.0 i V6 4WD 2.5 D 4WD, 55 kW 2.5 D 4WD, 59 kW 2.5 D, 61 kW 2.5 D 4WD, 61 kW 2.7 D 4WD, 73 kW	03.86 - 04.92		11866 40160-93G25 	
	04.92 - 02.98			
	04.92 - 02.98			
	09.90 - 02.98			
	03.86 - 08.91			
	08.87 - 02.98			
	03.96 - 02.98			
	08.87 - 02.98			
Lenkzwischenhebel / Idler Arm 2.4 i 4WD 2.5 D 4WD, 55 kW 2.5 D 4WD, 59 kW 2.5 D 4WD, 61 kW 2.4 i 12V 4WD		03.86 - 04.92 03.86 - 08.91 08.87 - 02.98 03.96 - 02.98 04.92 - 02.98	LHD 10.1993->	16250 48530-31G25 

PRAIRIE (M10, NM10)

01.83 - 10.88







Spurstangenkopf / Tie-rod End Gewindeart: mit Rechtsgewinde / Thread Type: with right-hand thread Gewindemaß / Thread Size: M22x1,5 1.8 SGL (M10), 66 kW	05.85 - 10.87		25200 48570-82100 
Spurstangenkopf / Tie-rod End Gewindeart: mit Linksgewinde / Thread Type: With left-hand thread Gewindemaß / Thread Size: M22x1,5 1.8 SGL (M10), 66 kW	05.85 - 10.87		25201 48580-82100 
Axialgelenk, Spurstange / Axial Rod, tie rod Gewindeart: mit Rechtsgewinde / Thread Type: with right-hand thread Gewindemaß / Thread Size: M12x1,25 1.5 S (M10) 1.8 SGL (M10)	01.84 - 12.87 07.83 - 10.87		11880 48521-70A06 
Axialgelenk, Spurstange / Axial Rod, tie rod radseitig / Wheel Side Aussengewinde [mm] / Outer Thread [mm]: M16x1 Aussengewinde [mm] / Outer Thread [mm]: M14x1,5 2.0 4x4 (NM10)	06.86 - 09.88		16298 48521-72E06 
Trag-/Führungsgelenk / Support-/ Steering Link ohne Zubehör / without accessories 2.0 4x4 (NM10)	06.86 - 09.88		11862 40160-85E00 



NISSAN

PRAIRIE (M10, NM10)









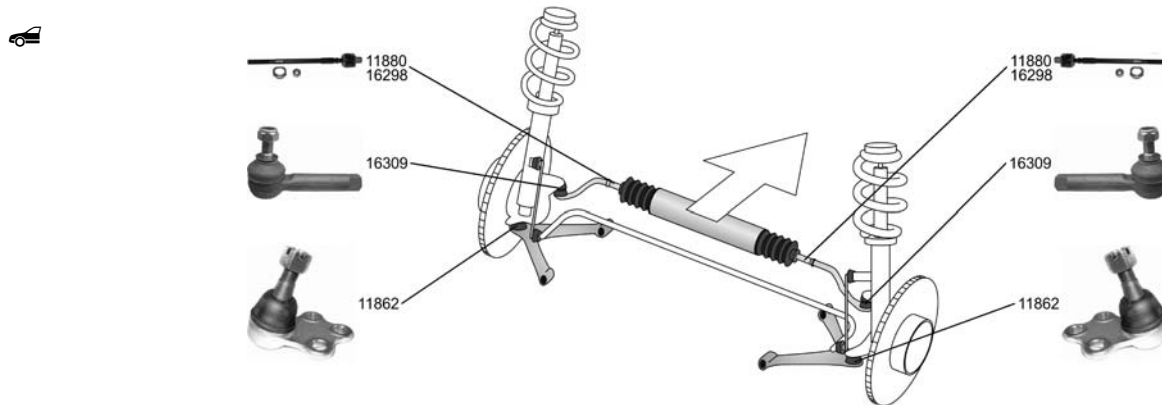

01.83 - 10.88

 Faltenbalgsatz, Lenkung / Bellow Kit, steering system 2.0 4x4 (NM10)		30146 48204-42L25 
		

PRAIRIE PRO (M11)

10.88 - 07.94



Spurstangenkopf / Tie-rod End Gewindeart: mit Rechtsgewinde / Thread Type: with right-hand thread Innengewinde [mm] / Inner Thread [mm]: M12x1,25 2.0 i 10.88 - 04.92 2.4 i 04.92 - 07.94		16309 48520-53E25 
Axialgelenk, Spurstange / Axial Rod, tie rod Gewindeart: mit Rechtsgewinde / Thread Type: with right-hand thread Gewindemaß / Thread Size: M12x1,25 2.0 i 10.88 - 04.92 2.4 i 04.92 - 07.94		11880 48521-70A06 
Axialgelenk, Spurstange / Axial Rod, tie rod radseitig / Wheel Side Aussengewinde [mm] / Outer Thread [mm]: M16x1 Aussengewinde [mm] / Outer Thread [mm]: M14x1,5 2.0 i 4x4 10.88 - 12.92 2.4 i 4x4 04.92 - 07.94		16298 48521-72E06 
Trag-/Führungsgelenk / Support-/ Steering Link ohne Zubehör / without accessories 2.0 i 10.88 - 04.92 2.0 i 4x4 10.88 - 12.92 2.4 i 04.92 - 07.94		11862 40160-85E00 
Faltenbalgsatz, Lenkung / Bellow Kit, steering system ALL TYPES		30174 48203-10V25 











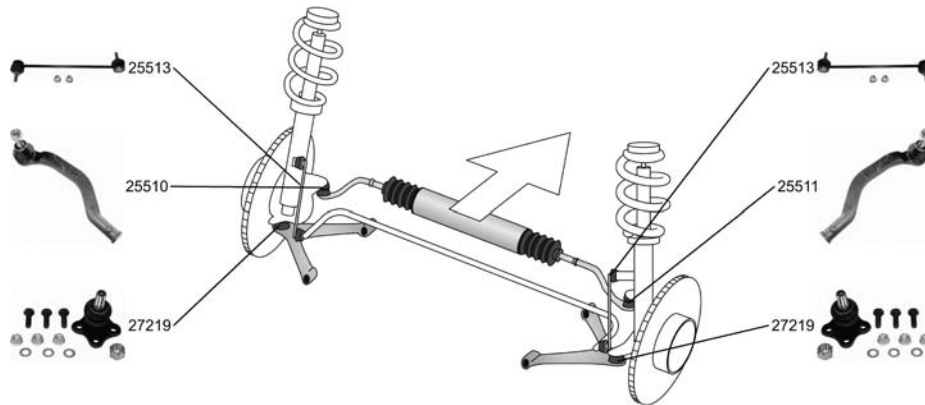



OE

NISSAN

PRIMASTAR Bus

09.02 -



<p>Spurstangenkopf / Tie-rod End ALL TYPES</p>		<p>25510 48520-00QAK</p> 
<p>Spurstangenkopf / Tie-rod End ALL TYPES</p>		<p>25511 48520-00QAL</p> 
<p>Trag-/Führungsgelenk / Support-/ Steering Link Konusmaß [mm] / Cone Size [mm]: 19,55 mit Zubehör / With accessories ALL TYPES</p>	 ->10.2006	<p>27219</p> 
<p>Lagerung, Lenker / Mounting, wishbone ALL TYPES</p>		<p>26938</p> 
<p>Lagerung, Lenker / Mounting, wishbone ALL TYPES</p>		<p>26939</p> 
<p>Stange/Strebe, Stabilisator / Rod/Strut, stabiliser Pendelstange / Suspension Rod mit Zubehör / With accessories ALL TYPES</p>		<p>25513 54616-00QAC</p> 









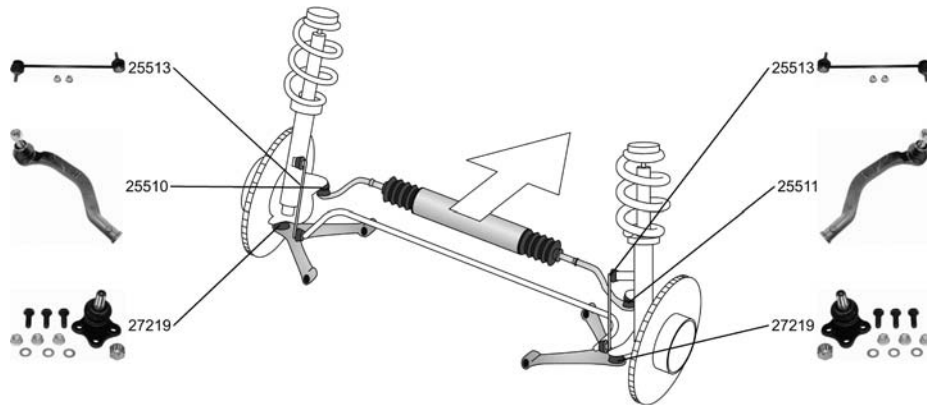





NISSAN

PRIMASTAR Kasten

09.02 -



<p>Spurstangenkopf / Tie-rod End ALL TYPES</p>		<p>25510 48520-00QAK</p> 
<p>Spurstangenkopf / Tie-rod End ALL TYPES</p>		<p>25511 48520-00QAL</p> 
<p>Trag-/Führungsgelenk / Support-/ Steering Link Konusmaß [mm] / Cone Size [mm]: 19,55 mit Zubehör / With accessories ALL TYPES</p>	 ->10.2006	<p>27219</p> 
<p>Lagerung, Lenker / Mounting, wishbone ALL TYPES</p>		<p>26938</p> 
<p>Lagerung, Lenker / Mounting, wishbone ALL TYPES</p>		<p>26939</p> 
<p>Stange/Strebe, Stabilisator / Rod/Strut, stabiliser Pendelstange / Suspension Rod mit Zubehör / With accessories ALL TYPES</p>		<p>25513 54616-00QAC</p> 











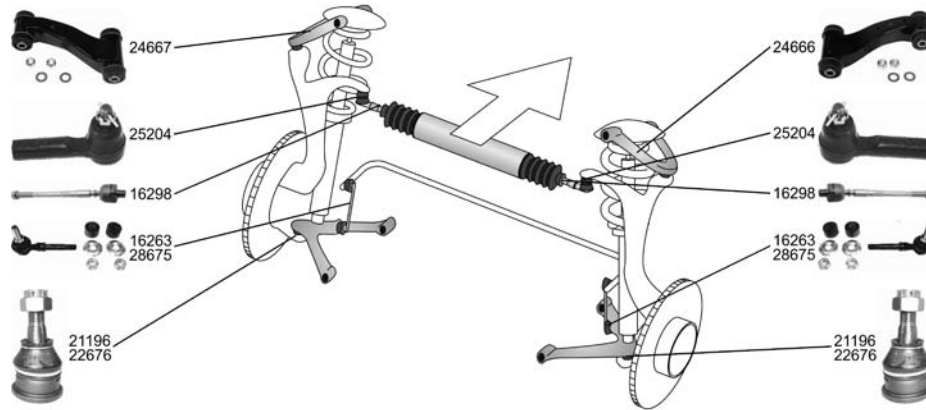









OE

NISSAN

PRIMERA (P10)

06.90 - 06.96









<p>Spurstangenkopf / Tie-rod End</p> <p>ALL TYPES ausser/except for : 1.6, 71 kW 06.90 - 01.96 2.0 16V 4x4 04.91 - 06.96</p>		<p>25204 48520-73J25</p> 
<p>Axialgelenk, Spurstange / Axial Rod, tie rod radseitig / Wheel Side Aussengewinde [mm] / Outer Thread [mm]: M16x1 Aussengewinde [mm] / Outer Thread [mm]: M14x1,5</p> <p>ALL TYPES ausser/except for : 1.6, 71 kW 06.90 - 01.96</p>		<p>16298 48521-72E06</p> 
<p>Lenker, Radaufhängung / Track Control Arm mit Zubehör / With accessories</p> <p>ALL TYPES</p>		<p>24666 54524-2F010</p> 
<p>Lenker, Radaufhängung / Track Control Arm mit Zubehör / With accessories</p> <p>ALL TYPES</p>		<p>24667 54525-2F010</p> 
<p>Trag-/Führungsgelenk / Support-/ Steering Link</p> <p>ALL TYPES ausser/except for : 1.6, 71 kW 06.90 - 01.96</p>		<p>21196</p> 
<p>Trag-/Führungsgelenk / Support-/ Steering Link</p> <p>ALL TYPES ausser/except for : 2.0 16V 4x4 04.91 - 06.96</p>		<p>22676 40160-70J00</p> 
<p>Stange/Strebe, Stabilisator / Rod/Strut, stabiliser Pendelstange / Suspension Rod</p> <p>1.6, 66 kW 06.90 - 01.96</p>		<p>16263 54618-50Y00</p> 
<p>Stange/Strebe, Stabilisator / Rod/Strut, stabiliser Pendelstange / Suspension Rod</p> <p>ALL TYPES ausser/except for : 1.6 06.90 - 01.96</p>		<p>28675 54618-50J20</p> 
<p>Faltenbalgsatz, Lenkung / Bellow Kit, steering system</p> <p>2.0 16V 06.90 - 01.96 2.0 i 01.95 - 06.96 2.0 GT 06.90 - 01.96</p>		<p>30174 48203-10V25</p> 











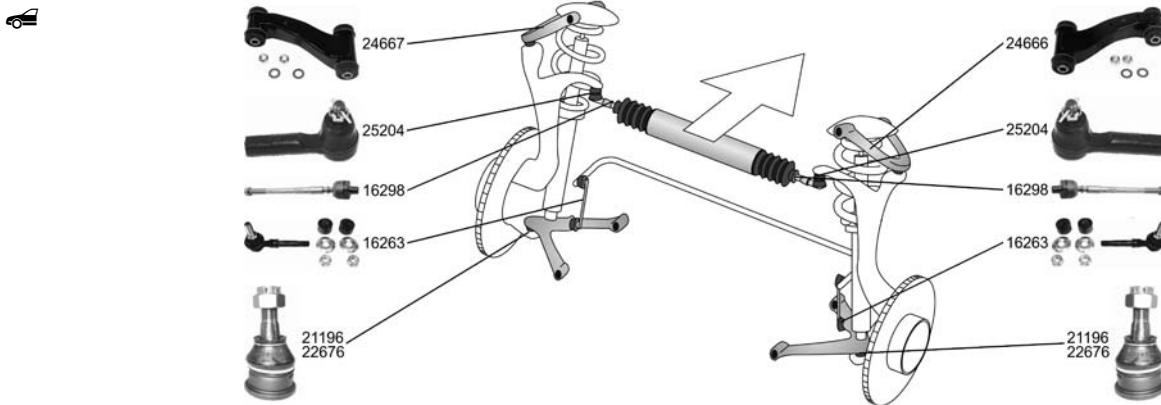



NISSAN

PRIMERA (P10) 06.90 - 06.96

	Faltenbaldsatz, Lenkung / Bellow Kit, steering system		30196 48203-Q9025
	1.6	06.90 - 01.96	
	2.0 16V	06.90 - 01.96	
	2.0 16V 4x4	04.91 - 06.96	
	2.0 GT	06.90 - 01.96	
2.0 D	01.91 - 01.96		
2.0 i	01.95 - 06.96	01.1992->	
	Stange/Strebe, Stabilisator / Rod/Strut, stabiliser Pendelstange / Suspension Rod		25202 56261-90J01
	ALL TYPES ausser/except for : 1.6, 71 kW	06.90 - 01.96	

PRIMERA Hatchback/avec hayon (P10) 06.90 - 06.96















	Spurstangenkopf / Tie-rod End		25204 48520-73J25
	1.6, 66 kW	06.90 - 01.96	
	2.0 16V	06.90 - 01.96	
	2.0 i	01.95 - 06.96	
	2.0 D	01.91 - 01.96	
	Axialgelenk, Spurstange / Axial Rod, tie rod radseitig / Wheel Side Aussengewinde [mm] / Outer Thread [mm]: M16x1 Aussengewinde [mm] / Outer Thread [mm]: M14x1,5		16298 48521-72E06
	1.6, 66 kW	06.90 - 01.96	
	2.0 16V	06.90 - 01.96	
	2.0 16V 4x4	04.91 - 06.96	
	2.0 i	01.95 - 06.96	
2.0 D	01.91 - 01.96		
	Lenker, Radaufhängung / Track Control Arm mit Zubehör / With accessories		24666 54524-2F010
	ALL TYPES ausser/except for : 2.0	06.90 - 01.96	
	2.0 16V ZX,GT	06.90 - 01.96	
	Lenker, Radaufhängung / Track Control Arm mit Zubehör / With accessories		24667 54525-2F010
	ALL TYPES ausser/except for : 2.0	06.90 - 01.96	
	2.0 16V ZX,GT	06.90 - 01.96	
	Trag-/Führungsgelenk / Support-/ Steering Link		21196
	1.6, 66 kW	06.90 - 01.96	
	2.0 16V	06.90 - 01.96	
	2.0 16V 4x4	04.91 - 06.96	
	2.0 i	01.95 - 06.96	
	2.0 D	01.91 - 01.96	



OE





NISSAN

PRIMERA Hatchback/avec hayon (P10) 06.90 - 06.96

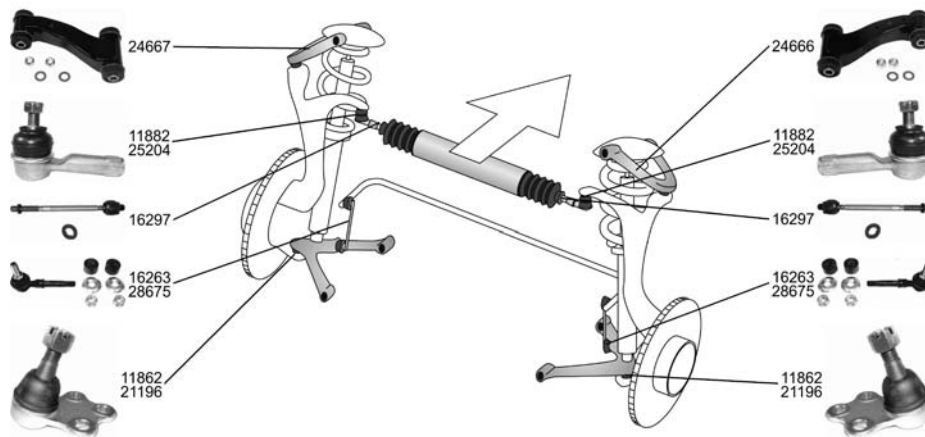
	Trag-/Führungsgelenk / Support-/ Steering Link		22676 40160-70J00
	ALL TYPES ausser/except for : 2.0 16V 4x4 04.91 - 06.96 2.0 06.90 - 01.96 2.0 16V ZX,GT 06.90 - 01.96		
	Stange/Strebe, Stabilisator / Rod/Strut, stabiliser Pendelstange / Suspension Rod		16263 54618-50Y00
	1.6, 66 kW 06.90 - 01.96		
	Faltenbalgsatz, Lenkung / Bellow Kit, steering system		30174 48203-10V25
	2.0 16V 06.90 - 01.96 2.0 i 01.95 - 06.96 2.0 06.90 - 01.96	->12.1991	
	Faltenbalgsatz, Lenkung / Bellow Kit, steering system		30196 48203-Q9025
	1.6, 66 kW 06.90 - 01.96 1.6, 71 kW 06.90 - 06.93 2.0 16V 06.90 - 01.96 2.0 16V 4x4 04.91 - 06.96 2.0 D 01.91 - 01.96 1.6, 75 kW 06.93 - 01.96 2.0 i 01.95 - 06.96	01.1992->	
	Stange/Strebe, Stabilisator / Rod/Strut, stabiliser Pendelstange / Suspension Rod		25202 56261-90J01
	1.6, 66 kW 06.90 - 01.96 2.0 16V 06.90 - 01.96 2.0 16V 4x4 04.91 - 06.96 2.0 i 01.95 - 06.96 2.0 D 01.91 - 01.96		

PRIMERA Traveller/Estate/Break (W10) 07.90 - 03.98























Spurstangenkopf / Tie-rod End Gewindeart: mit Rechtsgewinde / Thread Type: with right-hand thread Innengewinde [mm] / Inner Thread [mm]: M12x1,25		11882 48520-02E26
1.6 i 07.90 - 03.98 2.0 i 07.90 - 03.98 2.0 D 07.90 - 12.95		
Spurstangenkopf / Tie-rod End		25204 48520-73J25
1.6 i 07.90 - 03.98 2.0 i 07.90 - 03.98 2.0 D 07.90 - 12.95		



NISSAN

**PRIMERA Traveller/Estate/Break
(W10)**

07.90 - 03.98

	Axialgelenk, Spurstange / Axial Rod, tie rod		16297	48521-50Y25
	1.6 i	07.90 - 03.98		
	2.0 i	07.90 - 03.98		
	2.0 D	07.90 - 12.95		
	Lenker, Radaufhängung / Track Control Arm mit Zubehör / With accessories		24666	54524-2F010
	1.6 i	07.90 - 03.98		
	2.0 i	07.90 - 03.98		
	2.0 D	07.90 - 12.95		
	Lenker, Radaufhängung / Track Control Arm mit Zubehör / With accessories		24667	54525-2F010
	1.6 i	07.90 - 03.98		
	2.0 i	07.90 - 03.98		
	2.0 D	07.90 - 12.95		
	Trag-/Führungsgelenk / Support-/ Steering Link ohne Zubehör / without accessories		11862	40160-85E00
	1.6 i	07.90 - 03.98		
	2.0 i	07.90 - 03.98		
	2.0 D	07.90 - 12.95		
	Trag-/Führungsgelenk / Support-/ Steering Link		21196	
	1.6 i	07.90 - 03.98		
	2.0 i	07.90 - 03.98		
	2.0 D	07.90 - 12.95		
	Stange/Strebe, Stabilisator / Rod/Strut, stabiliser Pendelstange / Suspension Rod		16263	54618-50Y00
	1.6 i	07.90 - 03.98		
	2.0 i	07.90 - 03.98		
	2.0 D	07.90 - 12.95		
	Stange/Strebe, Stabilisator / Rod/Strut, stabiliser Pendelstange / Suspension Rod		28675	54618-50J20
	2.0 D	07.90 - 12.95		
	Faltenbalgsatz, Lenkung / Bellow Kit, steering system		30174	48203-10V25
	2.0 i	07.90 - 03.98		
	Stange/Strebe, Stabilisator / Rod/Strut, stabiliser Pendelstange / Suspension Rod		25202	56261-90J01
	1.6 i	07.90 - 03.98		
	2.0 i	07.90 - 03.98		
	2.0 D	07.90 - 12.95		











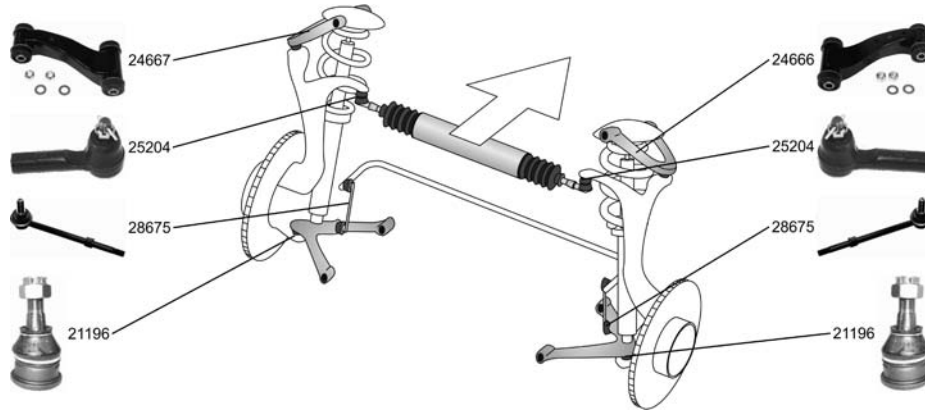



OE

NISSAN

PRIMERA (P11)

06.96 -



<p>Spurstangenkopf / Tie-rod End ALL TYPES ausser/except for : 1.6 16V, 78 kW 09.00 -</p>		<p>25204 48520-73J25</p> 
<p>Lenker, Radaufhängung / Track Control Arm mit Zubehör / With accessories ALL TYPES ausser/except for : 1.6 16V, 78 kW 09.00 -</p>		<p>24666 54524-2F010</p> 
<p>Lenker, Radaufhängung / Track Control Arm mit Zubehör / With accessories ALL TYPES ausser/except for : 1.6 16V, 78 kW 09.00 -</p>		<p>24667 54525-2F010</p> 
<p>Trag-/Führungsgelenk / Support-/ Steering Link ALL TYPES ausser/except for : 1.6 16V, 78 kW 09.00 -</p>		<p>21196</p> 
<p>Stange/Strebe, Stabilisator / Rod/Strut, stabiliser Pendelstange / Suspension Rod 2.0 16V 09.96 - 2.0 TD 09.96 -</p>		<p>28675 54618-50J20</p> 
<p>Faltenbalsatz, Lenkung / Bellow Kit, steering system ALL TYPES</p>		<p>30196 48203-Q9025</p> 









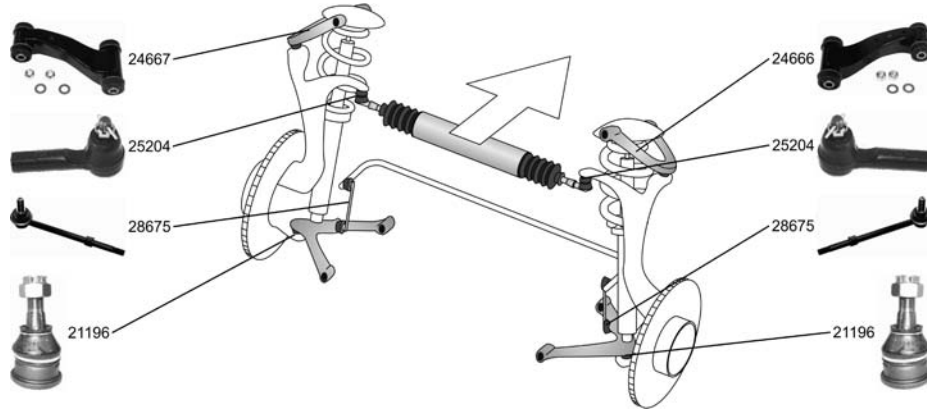





NISSAN

PRIMERA Hatchback/avec hayon (P11)

06.96 - 07.02



<p>Spurstangenkopf / Tie-rod End</p> <p>ALL TYPES ausser/except for : 1.6 16V, 78 kW 09.00 - 07.02</p>		<p>25204 48520-73J25</p> 
<p>Lenker, Radaufhängung / Track Control Arm mit Zubehör / With accessories</p> <p>ALL TYPES ausser/except for : 1.6 16V, 78 kW 09.00 - 07.02</p>		<p>24666 54524-2F010</p> 
<p>Lenker, Radaufhängung / Track Control Arm mit Zubehör / With accessories</p> <p>ALL TYPES ausser/except for : 1.6 16V, 78 kW 09.00 - 07.02</p>		<p>24667 54525-2F010</p> 
<p>Trag-/Führungsgelenk / Support-/ Steering Link</p> <p>ALL TYPES ausser/except for : 1.6 16V, 78 kW 09.00 - 07.02</p>		<p>21196</p> 
<p>Stange/Strebe, Stabilisator / Rod/Strut, stabiliser Pendelstange / Suspension Rod</p> <p>2.0 16V 09.96 - 07.02 2.0 TD 09.96 - 07.02</p>		<p>28675 54618-50J20</p> 
<p>Faltenbalsatz, Lenkung / Bellow Kit, steering system</p> <p>ALL TYPES</p>		<p>30196 48203-Q9025</p> 











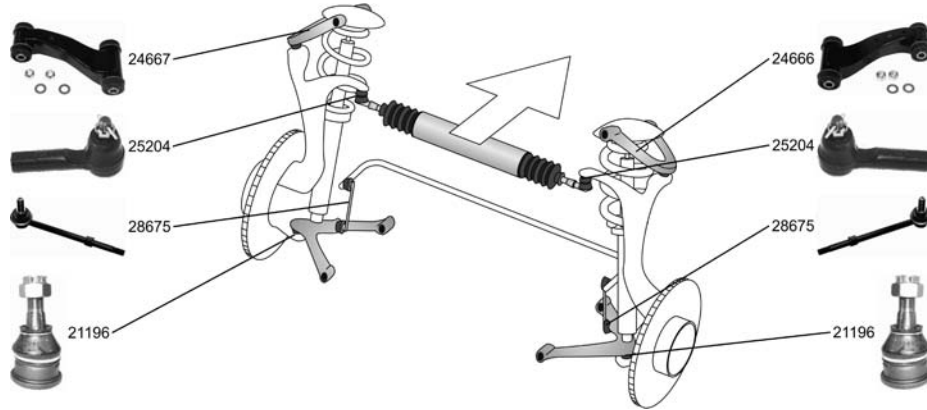

OE

NISSAN

**PRIMERA Traveller/Estate/Break
(WP11)**

04.98 -



<p>Spurstangenkopf / Tie-rod End ALL TYPES</p>		<p>25204 48520-73J25</p> 
<p>Lenker, Radaufhängung / Track Control Arm mit Zubehör / With accessories ALL TYPES</p>		<p>24666 54524-2F010</p> 
<p>Lenker, Radaufhängung / Track Control Arm mit Zubehör / With accessories ALL TYPES</p>		<p>24667 54525-2F010</p> 
<p>Trag-/Führungsgelenk / Support-/ Steering Link ALL TYPES</p>		<p>21196</p> 
<p>Stange/Strebe, Stabilisator / Rod/Strut, stabiliser Pendelstange / Suspension Rod</p> <p>2.0 16V, 85 kW 04.98 - 2.0 16V, 103 kW 08.99 - 2.0 TD 04.98 -</p>		<p>28675 54618-50J20</p> 





NISSAN

PRIMERA (P12)

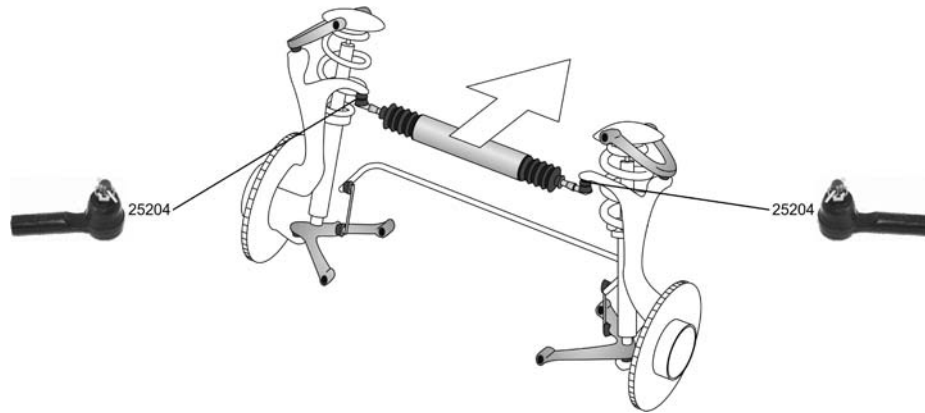
03.02 -





Spurstangenkopf / Tie-rod End			25204	48520-73J25
2.2 Di 2.2 dCi	03.02 - 04.03 -			

PRIMERA Hatchback/avec hayon (P12)

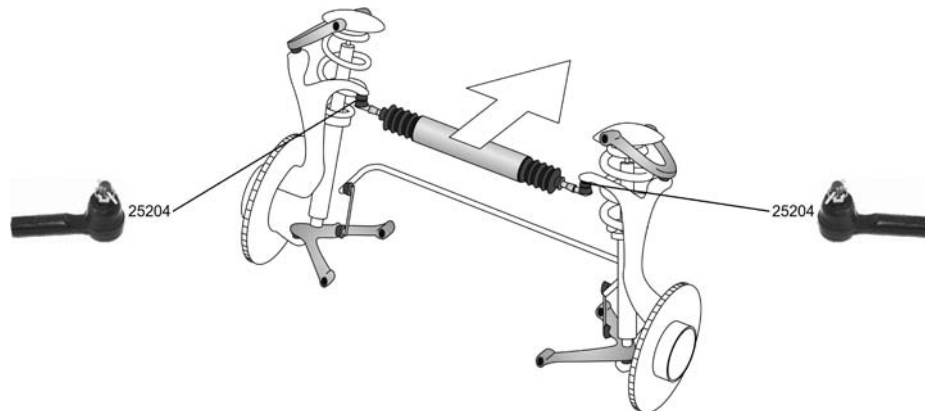
07.02 -



Spurstangenkopf / Tie-rod End			25204	48520-73J25
2.2 Di 2.2 dCi	07.02 - 04.03 -			











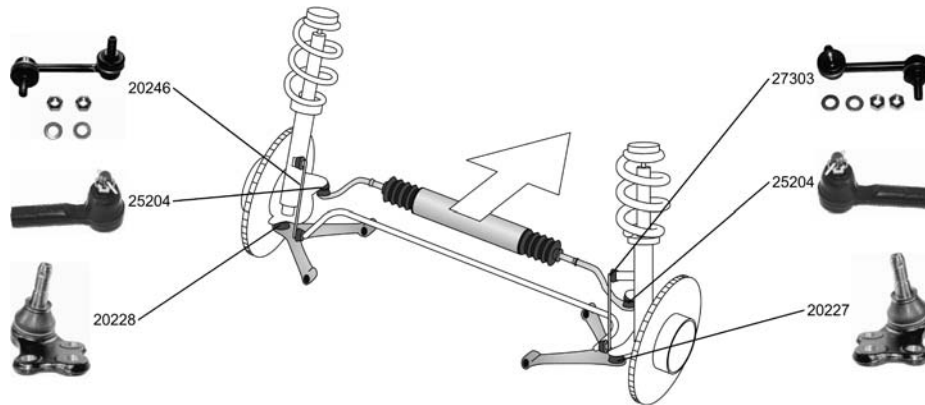

OE

NISSAN

SERENA (C23M)

07.92 -



Spurstangenkopf / Tie-rod End		25204	48520-73J25
1.6 16V	02.93 -		
2.0 16V	11.92 -		
2.0 D, Großraumlimousine	11.92 -		
2.3 D, Großraumlimousine	01.95 -		
Trag-/Führungsgelenk / Support-/ Steering Link mit Zubehör / With accessories		20227	40160-9C500
1.6 16V	02.93 -		
2.0 16V	11.92 -		
2.0 D, Großraumlimousine	11.92 -		
2.3 D, Großraumlimousine	01.95 -		
Trag-/Führungsgelenk / Support-/ Steering Link mit Zubehör / With accessories		20228	40161-9C500
1.6 16V	02.93 -		
2.0 16V	11.92 -		
2.0 D, Großraumlimousine	11.92 -		
2.3 D, Großraumlimousine	01.95 -		
Stange/Strebe, Stabilisator / Rod/Strut, stabiliser Pendelstange / Suspension Rod		20246	54668-9C000
1.6 16V	02.93 -		
2.0 16V	11.92 -		
2.0 D, Großraumlimousine	11.92 -		
2.3 D, Großraumlimousine	01.95 -		
Stange/Strebe, Stabilisator / Rod/Strut, stabiliser Pendelstange / Suspension Rod mit Zubehör / With accessories		27303	54618-9C002
1.6 16V	02.93 -		
2.0 16V	11.92 -		
2.0 D, Großraumlimousine	11.92 -		
2.3 D, Großraumlimousine	01.95 -		

SILVIA (S12)

04.84 - 09.88



Axialgelenk, Spurstange / Axial Rod, tie rod

Gewindeart: mit Rechtsgewinde / Thread Type: with right-hand thread
Gewindemaß / Thread Size: M12x1,25

2.0 GP

04.84 - 09.88



11880

48521-70A06



SUNNY I (B11)

03.82 - 08.90



Spurstange / Tie Rod, steering

1.5

03.82 - 10.86

1.7 D

03.82 - 10.86

1.3

03.82 - 09.87



15586

48510-70A27



Axialgelenk, Spurstange / Axial Rod, tie rod

Gewindeart: mit Rechtsgewinde / Thread Type: with right-hand thread
Gewindemaß / Thread Size: M12x1,25

1.3

03.82 - 09.87

1.5

03.82 - 10.86

1.7 D

03.82 - 10.86



11880

48521-70A06











NISSAN















SUNNY I (B11)

03.82 - 08.90

	Axialgelenk, Spurstange / Axial Rod, tie rod Gewindeart: mit Rechtsgewinde / Thread Type: with right-hand thread Gewindemaß / Thread Size: M12x1,25		16301	48521-35A06
	1.3	03.82 - 09.87		
	1.5	03.82 - 10.86		
1.7 D	03.82 - 10.86			
	Faltenbalgsatz, Lenkung / Bellow Kit, steering system		30145	48203-05F26
	1.5	03.82 - 10.86		
	1.7 D	03.82 - 10.86		
1.3	03.82 - 09.87			
	Faltenbalgsatz, Lenkung / Bellow Kit, steering system		30147	48204-53A00
	1.5	03.82 - 10.86		
	1.7 D	03.82 - 10.86		
1.3	03.82 - 09.87			





SUNNY I Coupe (B11)

03.82 - 08.90

	Spurstange / Tie Rod, steering ALL TYPES		15586	48510-70A27
				
	Axialgelenk, Spurstange / Axial Rod, tie rod Gewindeart: mit Rechtsgewinde / Thread Type: with right-hand thread Gewindemaß / Thread Size: M12x1,25			
		ALL TYPES		
	Axialgelenk, Spurstange / Axial Rod, tie rod Gewindeart: mit Rechtsgewinde / Thread Type: with right-hand thread Gewindemaß / Thread Size: M12x1,25		16301	
		ALL TYPES		
	Faltenbalgsatz, Lenkung / Bellow Kit, steering system		30145	
	1.5	03.82 - 10.86	 07.1984->	
1.7 D	03.82 - 10.86			
	Faltenbalgsatz, Lenkung / Bellow Kit, steering system		30147	48204-53A00
	1.5	03.82 - 10.86	 09.1985->	
1.7 D	03.82 - 10.86			

SUNNY I Traveller/Estate/Break (B11)

03.82 - 08.90

	Spurstange / Tie Rod, steering		15586	48510-70A27
	1.5	03.82 - 10.86		
1.7 D	03.82 - 10.86			
	Axialgelenk, Spurstange / Axial Rod, tie rod Gewindeart: mit Rechtsgewinde / Thread Type: with right-hand thread Gewindemaß / Thread Size: M12x1,25		11880	48521-70A06
	1.5	03.82 - 10.86		
1.7 D	03.82 - 10.86			











OE

NISSAN

SUNNY I Traveller/Estate/Break (B11)









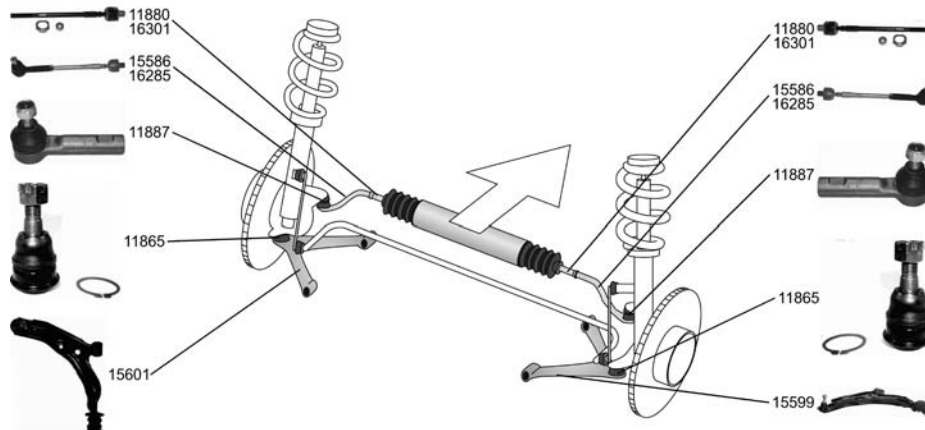

03.82 - 08.90

 Axialgelenk, Spurstange / Axial Rod, tie rod Gewindeart: mit Rechtsgewinde / Thread Type: with right-hand thread Gewindemaß / Thread Size: M12x1,25			16301 48521-35A06 
	1.5 03.82 - 10.86 1.7 D 03.82 - 10.86		
Faltenbalgsatz, Lenkung / Bellow Kit, steering system 1.5	03.82 - 10.86	  07.1984->	30145 48203-05F26 
	1.7 D		
Faltenbalgsatz, Lenkung / Bellow Kit, steering system 1.5	03.82 - 10.86	  09.1985->	30147 48204-53A00 
	1.7 D		

SUNNY II Traveller/Estate/Break (B12)

01.86 - 08.90



Spurstange / Tie Rod, steering ALL TYPES ausser/except for : 1.6 4x4 1.6	08.86 - 05.90	 	15586 48510-70A27 
	10.88 - 05.90		
Spurstange / Tie Rod, steering ALL TYPES ausser/except for : 1.6 4x4 1.6	08.86 - 05.90	 	16285 48510-53A26 
	10.88 - 05.90		
Spurstangenkopf / Tie-rod End Gewindeart: mit Rechtsgewinde / Thread Type: with right-hand thread Gewindemaß / Thread Size: M12x1,25 Innengewinde [mm] / Inner Thread [mm]: M12x1,25			11887 48520-50A26 
	ALL TYPES ausser/except for : 1.6 4x4 08.86 - 05.90 1.6 10.88 - 05.90		
Axialgelenk, Spurstange / Axial Rod, tie rod Gewindeart: mit Rechtsgewinde / Thread Type: with right-hand thread Gewindemaß / Thread Size: M12x1,25		 	11880 48521-70A06 
	ALL TYPES ausser/except for : 1.6 4x4 08.86 - 05.90 1.6 10.88 - 05.90		



NISSAN

SUNNY II Traveller/Estate/Break (B12)



01.86 - 08.90

 Axialgelenk, Spurstange / Axial Rod, tie rod Gewindeart: mit Rechtsgewinde / Thread Type: with right-hand thread Gewindemaß / Thread Size: M12x1,25		16301 48521-35A06 
ALL TYPES ausser/except for : 1.6 4x4 08.86 - 05.90 1.6 10.88 - 05.90		
Lenker, Radaufhängung / Track Control Arm ALL TYPES ausser/except for : 1.6 4x4 08.86 - 05.90 1.6 10.88 - 05.90		15599 54500-50A00 
Lenker, Radaufhängung / Track Control Arm ALL TYPES ausser/except for : 1.6 4x4 08.86 - 05.90 1.6 10.88 - 05.90		15601 54501-50A00 
Trag-/Führungsgelenk / Support-/ Steering Link ALL TYPES ausser/except for : 1.6 4x4 08.86 - 05.90 1.6 10.88 - 05.90		11865 40160-50A00 
Faltenbalgsatz, Lenkung / Bellow Kit, steering system 1.5 06.86 - 10.88 1.6 i 08.86 - 05.89 1.6 i 4x4 (A) 06.86 - 05.89 1.6 06.86 - 10.88 1.6 i 12V 10.88 - 06.91 1.7 D 01.86 - 06.91		30145 48203-05F26 
Faltenbalgsatz, Lenkung / Bellow Kit, steering system 1.6 i 08.86 - 05.89 1.6 06.86 - 10.88 1.6 i 4x4 (A) 06.86 - 05.89 1.7 D 01.86 - 06.91	    ->01.1990	30147 48204-53A00 

SUNNY II Coupe (B12)

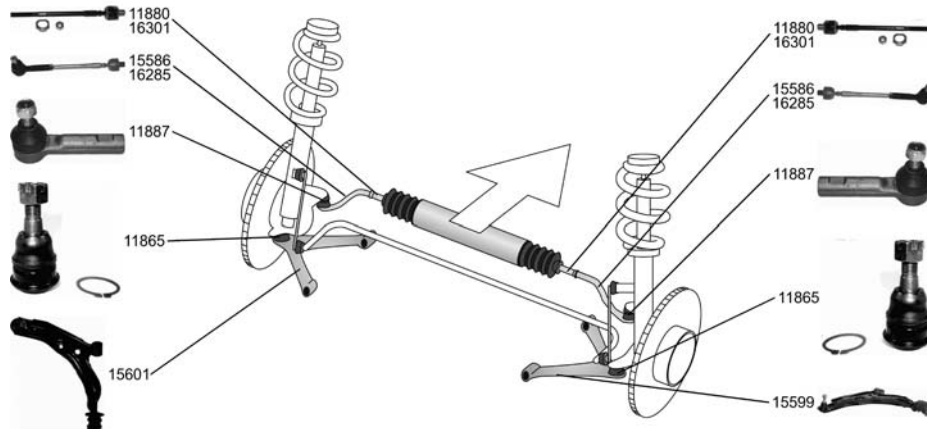
06.86 - 08.90



Spurstange / Tie Rod, steering ALL TYPES ausser/except for : 1.6 11.88 - 06.91	 	15586 48510-70A27 
--	--	---































OE

NISSAN

SUNNY II Coupe (B12)

06.86 - 08.90

<p> Spurstange / Tie Rod, steering ALL TYPES ausser/except for : 1.6 11.88 - 06.91</p>	<p> </p>	<p>16285 48510-53A26 </p>
<p>Spurstangenkopf / Tie-rod End Gewindeart: mit Rechtsgewinde / Thread Type: with right-hand thread Gewindemaß / Thread Size: M12x1,25 Innengewinde [mm] / Inner Thread [mm]: M12x1,25 ALL TYPES ausser/except for : 1.6 11.88 - 06.91</p>	<p> </p>	<p>11887 48520-50A26 </p>
<p>Axialgelenk, Spurstange / Axial Rod, tie rod Gewindeart: mit Rechtsgewinde / Thread Type: with right-hand thread Gewindemaß / Thread Size: M12x1,25 ALL TYPES ausser/except for : 1.6 11.88 - 06.91</p>	<p>  </p>	<p>11880 48521-70A06 </p>
<p>Axialgelenk, Spurstange / Axial Rod, tie rod Gewindeart: mit Rechtsgewinde / Thread Type: with right-hand thread Gewindemaß / Thread Size: M12x1,25 ALL TYPES ausser/except for : 1.6 11.88 - 06.91</p>	<p>  </p>	<p>16301 48521-35A06 </p>
<p>Lenker, Radaufhängung / Track Control Arm ALL TYPES ausser/except for : 1.6 11.88 - 06.91</p>	<p></p>	<p>15599 54500-50A00 </p>
<p>Lenker, Radaufhängung / Track Control Arm ALL TYPES ausser/except for : 1.6 11.88 - 06.91</p>	<p></p>	<p>15601 54501-50A00 </p>
<p>Trag-/Führungsgelenk / Support-/ Steering Link ALL TYPES ausser/except for : 1.6 11.88 - 06.91</p>	<p>  </p>	<p>11865 40160-50A00 </p>
<p>Faltenbalgsatz, Lenkung / Bellow Kit, steering system ALL TYPES ausser/except for : 1.6 11.88 - 06.91</p>	<p></p>	<p>30145 48203-05F26 </p>
<p>Faltenbalgsatz, Lenkung / Bellow Kit, steering system 1.6 i 06.86 - 05.89 1.6 06.86 - 10.88 1.8 GTI 16V 01.89 - 06.91</p>	<p>   ->01.1990</p>	<p>30147 48204-53A00 </p>









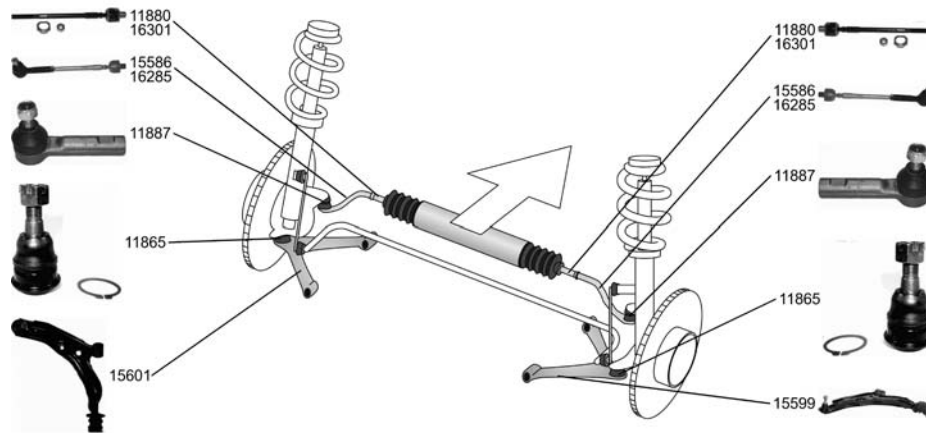





NISSAN

SUNNY II (N13)

06.86 - 10.90



<p>Spurstange / Tie Rod, steering</p> <table border="1"> <tr><td>1.3</td><td>07.86 - 10.91</td></tr> <tr><td>1.4 LX</td><td>10.88 - 08.91</td></tr> <tr><td>1.5</td><td>06.86 - 10.88</td></tr> <tr><td>1.6 i</td><td>06.86 - 10.90</td></tr> <tr><td>1.6 i 4x4 (A)</td><td>06.86 - 10.90</td></tr> <tr><td>1.6</td><td>06.86 - 10.88</td></tr> <tr><td>1.6 i 12V</td><td>10.88 - 06.91</td></tr> <tr><td>1.6 GTI 16V</td><td>02.87 - 10.88</td></tr> <tr><td>1.7 D</td><td>06.86 - 05.89</td></tr> </table>	1.3	07.86 - 10.91	1.4 LX	10.88 - 08.91	1.5	06.86 - 10.88	1.6 i	06.86 - 10.90	1.6 i 4x4 (A)	06.86 - 10.90	1.6	06.86 - 10.88	1.6 i 12V	10.88 - 06.91	1.6 GTI 16V	02.87 - 10.88	1.7 D	06.86 - 05.89	 	<p>15586 48510-70A27</p> 
1.3	07.86 - 10.91																			
1.4 LX	10.88 - 08.91																			
1.5	06.86 - 10.88																			
1.6 i	06.86 - 10.90																			
1.6 i 4x4 (A)	06.86 - 10.90																			
1.6	06.86 - 10.88																			
1.6 i 12V	10.88 - 06.91																			
1.6 GTI 16V	02.87 - 10.88																			
1.7 D	06.86 - 05.89																			
<p>Spurstange / Tie Rod, steering</p> <table border="1"> <tr><td>1.3</td><td>07.86 - 10.91</td></tr> <tr><td>1.4 LX</td><td>10.88 - 08.91</td></tr> <tr><td>1.5</td><td>06.86 - 10.88</td></tr> <tr><td>1.6 i</td><td>06.86 - 10.90</td></tr> <tr><td>1.6 i 4x4 (A)</td><td>06.86 - 10.90</td></tr> <tr><td>1.6</td><td>06.86 - 10.88</td></tr> <tr><td>1.6 i 12V</td><td>10.88 - 06.91</td></tr> <tr><td>1.6 GTI 16V</td><td>02.87 - 10.88</td></tr> <tr><td>1.7 D</td><td>06.86 - 05.89</td></tr> </table>	1.3	07.86 - 10.91	1.4 LX	10.88 - 08.91	1.5	06.86 - 10.88	1.6 i	06.86 - 10.90	1.6 i 4x4 (A)	06.86 - 10.90	1.6	06.86 - 10.88	1.6 i 12V	10.88 - 06.91	1.6 GTI 16V	02.87 - 10.88	1.7 D	06.86 - 05.89	 	<p>16285 48510-53A26</p> 
1.3	07.86 - 10.91																			
1.4 LX	10.88 - 08.91																			
1.5	06.86 - 10.88																			
1.6 i	06.86 - 10.90																			
1.6 i 4x4 (A)	06.86 - 10.90																			
1.6	06.86 - 10.88																			
1.6 i 12V	10.88 - 06.91																			
1.6 GTI 16V	02.87 - 10.88																			
1.7 D	06.86 - 05.89																			
<p>Spurstangenkopf / Tie-rod End Gewindeart: mit Rechtsgewinde / Thread Type: with right-hand thread Gewindemaß / Thread Size: M12x1,25 Innengewinde [mm] / Inner Thread [mm]: M12x1,25</p> <table border="1"> <tr><td>1.3</td><td>07.86 - 10.91</td></tr> <tr><td>1.4 LX</td><td>10.88 - 08.91</td></tr> <tr><td>1.5</td><td>06.86 - 10.88</td></tr> <tr><td>1.6 i</td><td>06.86 - 10.90</td></tr> <tr><td>1.6 i 4x4 (A)</td><td>06.86 - 10.90</td></tr> <tr><td>1.6</td><td>06.86 - 10.88</td></tr> <tr><td>1.6 i 12V</td><td>10.88 - 06.91</td></tr> <tr><td>1.6 GTI 16V</td><td>02.87 - 10.88</td></tr> <tr><td>1.7 D</td><td>06.86 - 05.89</td></tr> </table>	1.3	07.86 - 10.91	1.4 LX	10.88 - 08.91	1.5	06.86 - 10.88	1.6 i	06.86 - 10.90	1.6 i 4x4 (A)	06.86 - 10.90	1.6	06.86 - 10.88	1.6 i 12V	10.88 - 06.91	1.6 GTI 16V	02.87 - 10.88	1.7 D	06.86 - 05.89	 	<p>11887 48520-50A26</p> 
1.3	07.86 - 10.91																			
1.4 LX	10.88 - 08.91																			
1.5	06.86 - 10.88																			
1.6 i	06.86 - 10.90																			
1.6 i 4x4 (A)	06.86 - 10.90																			
1.6	06.86 - 10.88																			
1.6 i 12V	10.88 - 06.91																			
1.6 GTI 16V	02.87 - 10.88																			
1.7 D	06.86 - 05.89																			
<p>Axialgelenk, Spurstange / Axial Rod, tie rod Gewindeart: mit Rechtsgewinde / Thread Type: with right-hand thread Gewindemaß / Thread Size: M12x1,25</p> <table border="1"> <tr><td>1.3</td><td>07.86 - 10.91</td></tr> <tr><td>1.4 LX</td><td>10.88 - 08.91</td></tr> <tr><td>1.5</td><td>06.86 - 10.88</td></tr> <tr><td>1.6 i</td><td>06.86 - 10.90</td></tr> <tr><td>1.6 i 4x4 (A)</td><td>06.86 - 10.90</td></tr> <tr><td>1.6</td><td>06.86 - 10.88</td></tr> <tr><td>1.6 i 12V</td><td>10.88 - 06.91</td></tr> <tr><td>1.6 GTI 16V</td><td>02.87 - 10.88</td></tr> <tr><td>1.7 D</td><td>06.86 - 05.89</td></tr> </table>	1.3	07.86 - 10.91	1.4 LX	10.88 - 08.91	1.5	06.86 - 10.88	1.6 i	06.86 - 10.90	1.6 i 4x4 (A)	06.86 - 10.90	1.6	06.86 - 10.88	1.6 i 12V	10.88 - 06.91	1.6 GTI 16V	02.87 - 10.88	1.7 D	06.86 - 05.89	 	<p>11880 48521-70A06</p> 
1.3	07.86 - 10.91																			
1.4 LX	10.88 - 08.91																			
1.5	06.86 - 10.88																			
1.6 i	06.86 - 10.90																			
1.6 i 4x4 (A)	06.86 - 10.90																			
1.6	06.86 - 10.88																			
1.6 i 12V	10.88 - 06.91																			
1.6 GTI 16V	02.87 - 10.88																			
1.7 D	06.86 - 05.89																			

















OE

NISSAN

SUNNY II (N13)

06.86 - 10.90

 Axialgelenk, Spurstange / Axial Rod, tie rod Gewindeart: mit Rechtsgewinde / Thread Type: with right-hand thread Gewindemaß / Thread Size: M12x1,25		16301 48521-35A06 
1.3 07.86 - 10.91 1.4 LX 10.88 - 08.91 1.5 06.86 - 10.88 1.6 i 06.86 - 10.90 1.6 i 4x4 (A) 06.86 - 10.90 1.6 06.86 - 10.88 1.6 i 12V 10.88 - 06.91 1.6 GTI 16V 02.87 - 10.88 1.7 D 06.86 - 05.89		
Lenker, Radaufhängung / Track Control Arm		15599 54500-50A00 
1.3 07.86 - 10.91 1.4 LX 10.88 - 08.91 1.5 06.86 - 10.88 1.6 i 06.86 - 10.90 1.6 i 4x4 (A) 06.86 - 10.90 1.6 06.86 - 10.88 1.6 i 12V 10.88 - 06.91 1.6 GTI 16V 02.87 - 10.88 1.7 D 06.86 - 05.89		
Lenker, Radaufhängung / Track Control Arm		15601 54501-50A00 
1.3 07.86 - 10.91 1.4 LX 10.88 - 08.91 1.5 06.86 - 10.88 1.6 i 06.86 - 10.90 1.6 i 4x4 (A) 06.86 - 10.90 1.6 06.86 - 10.88 1.6 i 12V 10.88 - 06.91 1.6 GTI 16V 02.87 - 10.88 1.7 D 06.86 - 05.89		11865 40160-50A00 
Trag-/Führungsgelenk / Support-/ Steering Link		
1.3 07.86 - 10.91 1.4 LX 10.88 - 08.91 1.5 06.86 - 10.88 1.6 i 06.86 - 10.90 1.6 i 4x4 (A) 06.86 - 10.90 1.6 06.86 - 10.88 1.6 i 12V 10.88 - 06.91 1.6 GTI 16V 02.87 - 10.88 1.7 D 06.86 - 05.89		30145 48203-05F26 
Faltenbalgsatz, Lenkung / Bellow Kit, steering system		
1.3 07.86 - 10.91 1.4 LX 10.88 - 08.91 1.5 06.86 - 10.88 1.6 i 06.86 - 10.90 1.6 i 4x4 (A) 06.86 - 10.90 1.6 06.86 - 10.88 1.6 i 12V 10.88 - 06.91 1.6 GTI 16V 02.87 - 10.88 1.7 D 06.86 - 05.89		30147 48204-53A00 
1.4 LX 10.88 - 08.91 1.6 i 06.86 - 10.90 1.6 06.86 - 10.88		
1.6 i 4x4 (A) 06.86 - 10.90 1.6 GTI 16V 02.87 - 10.88 1.7 D 06.86 - 05.89		
1.3 07.86 - 10.91		









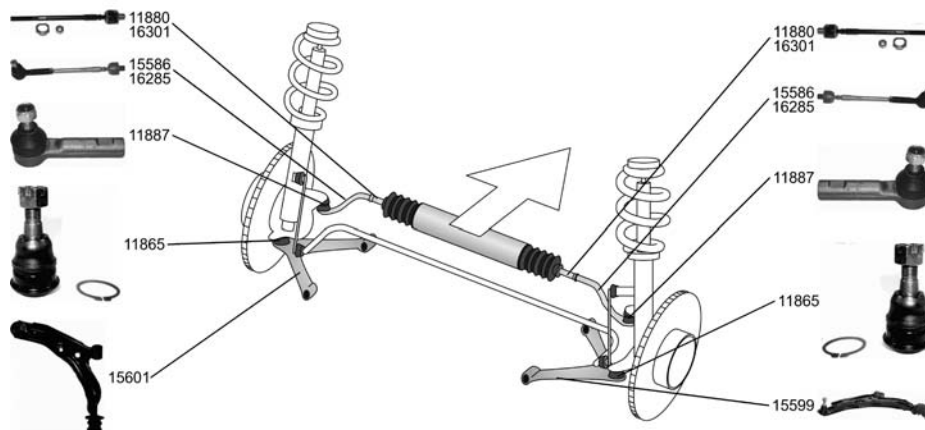



NISSAN

SUNNY II Hatchback/avec hayon (N13)

06.86 - 10.90



<p>Spurstange / Tie Rod, steering</p> <table border="1"> <tr><td>1.3</td><td>06.86 - 10.88</td></tr> <tr><td>1.4 LX</td><td>01.89 - 08.91</td></tr> <tr><td>1.5</td><td>06.86 - 10.88</td></tr> <tr><td>1.6 i</td><td>06.86 - 10.90</td></tr> <tr><td>1.6</td><td>06.86 - 10.88</td></tr> <tr><td>1.6 i 12V</td><td>06.86 - 10.90</td></tr> <tr><td>1.6 GTI 16V</td><td>06.87 - 05.89</td></tr> <tr><td>1.8 GTI 16V</td><td>01.89 - 06.91</td></tr> <tr><td>1.7 D</td><td>06.86 - 01.91</td></tr> </table>	1.3	06.86 - 10.88	1.4 LX	01.89 - 08.91	1.5	06.86 - 10.88	1.6 i	06.86 - 10.90	1.6	06.86 - 10.88	1.6 i 12V	06.86 - 10.90	1.6 GTI 16V	06.87 - 05.89	1.8 GTI 16V	01.89 - 06.91	1.7 D	06.86 - 01.91	 	<p>15586 48510-70A27</p> 
1.3	06.86 - 10.88																			
1.4 LX	01.89 - 08.91																			
1.5	06.86 - 10.88																			
1.6 i	06.86 - 10.90																			
1.6	06.86 - 10.88																			
1.6 i 12V	06.86 - 10.90																			
1.6 GTI 16V	06.87 - 05.89																			
1.8 GTI 16V	01.89 - 06.91																			
1.7 D	06.86 - 01.91																			
<p>Spurstange / Tie Rod, steering</p> <table border="1"> <tr><td>1.3</td><td>06.86 - 10.88</td></tr> <tr><td>1.4 LX</td><td>01.89 - 08.91</td></tr> <tr><td>1.5</td><td>06.86 - 10.88</td></tr> <tr><td>1.6 i</td><td>06.86 - 10.90</td></tr> <tr><td>1.6</td><td>06.86 - 10.88</td></tr> <tr><td>1.6 i 12V</td><td>06.86 - 10.90</td></tr> <tr><td>1.6 GTI 16V</td><td>06.87 - 05.89</td></tr> <tr><td>1.8 GTI 16V</td><td>01.89 - 06.91</td></tr> <tr><td>1.7 D</td><td>06.86 - 01.91</td></tr> </table>	1.3	06.86 - 10.88	1.4 LX	01.89 - 08.91	1.5	06.86 - 10.88	1.6 i	06.86 - 10.90	1.6	06.86 - 10.88	1.6 i 12V	06.86 - 10.90	1.6 GTI 16V	06.87 - 05.89	1.8 GTI 16V	01.89 - 06.91	1.7 D	06.86 - 01.91	 	<p>16285 48510-53A26</p> 
1.3	06.86 - 10.88																			
1.4 LX	01.89 - 08.91																			
1.5	06.86 - 10.88																			
1.6 i	06.86 - 10.90																			
1.6	06.86 - 10.88																			
1.6 i 12V	06.86 - 10.90																			
1.6 GTI 16V	06.87 - 05.89																			
1.8 GTI 16V	01.89 - 06.91																			
1.7 D	06.86 - 01.91																			
<p>Spurstangenkopf / Tie-rod End Gewindeart: mit Rechtsgewinde / Thread Type: with right-hand thread Gewindemaß / Thread Size: M12x1,25 Innengewinde [mm] / Inner Thread [mm]: M12x1,25</p> <table border="1"> <tr><td>1.3</td><td>06.86 - 10.88</td></tr> <tr><td>1.4 LX</td><td>01.89 - 08.91</td></tr> <tr><td>1.5</td><td>06.86 - 10.88</td></tr> <tr><td>1.6 i</td><td>06.86 - 10.90</td></tr> <tr><td>1.6</td><td>06.86 - 10.88</td></tr> <tr><td>1.6 i 12V</td><td>06.86 - 10.90</td></tr> <tr><td>1.6 GTI 16V</td><td>06.87 - 05.89</td></tr> <tr><td>1.8 GTI 16V</td><td>01.89 - 06.91</td></tr> <tr><td>1.7 D</td><td>06.86 - 01.91</td></tr> </table>	1.3	06.86 - 10.88	1.4 LX	01.89 - 08.91	1.5	06.86 - 10.88	1.6 i	06.86 - 10.90	1.6	06.86 - 10.88	1.6 i 12V	06.86 - 10.90	1.6 GTI 16V	06.87 - 05.89	1.8 GTI 16V	01.89 - 06.91	1.7 D	06.86 - 01.91		<p>11887 48520-50A26</p> 
1.3	06.86 - 10.88																			
1.4 LX	01.89 - 08.91																			
1.5	06.86 - 10.88																			
1.6 i	06.86 - 10.90																			
1.6	06.86 - 10.88																			
1.6 i 12V	06.86 - 10.90																			
1.6 GTI 16V	06.87 - 05.89																			
1.8 GTI 16V	01.89 - 06.91																			
1.7 D	06.86 - 01.91																			
<p>Axialgelenk, Spurstange / Axial Rod, tie rod Gewindeart: mit Rechtsgewinde / Thread Type: with right-hand thread Gewindemaß / Thread Size: M12x1,25</p> <table border="1"> <tr><td>1.3</td><td>06.86 - 10.88</td></tr> <tr><td>1.4 LX</td><td>01.89 - 08.91</td></tr> <tr><td>1.5</td><td>06.86 - 10.88</td></tr> <tr><td>1.6 i</td><td>06.86 - 10.90</td></tr> <tr><td>1.6</td><td>06.86 - 10.88</td></tr> <tr><td>1.6 i 12V</td><td>06.86 - 10.90</td></tr> <tr><td>1.6 GTI 16V</td><td>06.87 - 05.89</td></tr> <tr><td>1.8 GTI 16V</td><td>01.89 - 06.91</td></tr> <tr><td>1.7 D</td><td>06.86 - 01.91</td></tr> </table>	1.3	06.86 - 10.88	1.4 LX	01.89 - 08.91	1.5	06.86 - 10.88	1.6 i	06.86 - 10.90	1.6	06.86 - 10.88	1.6 i 12V	06.86 - 10.90	1.6 GTI 16V	06.87 - 05.89	1.8 GTI 16V	01.89 - 06.91	1.7 D	06.86 - 01.91	 	<p>11880 48521-70A06</p> 
1.3	06.86 - 10.88																			
1.4 LX	01.89 - 08.91																			
1.5	06.86 - 10.88																			
1.6 i	06.86 - 10.90																			
1.6	06.86 - 10.88																			
1.6 i 12V	06.86 - 10.90																			
1.6 GTI 16V	06.87 - 05.89																			
1.8 GTI 16V	01.89 - 06.91																			
1.7 D	06.86 - 01.91																			



OE

NISSAN

SUNNY II Hatchback/avec hayon (N13)

06.86 - 10.90

 Axialgelenk, Spurstange / Axial Rod, tie rod Gewindeart: mit Rechtsgewinde / Thread Type: with right-hand thread Gewindemaß / Thread Size: M12x1,25		16301 48521-35A06 
1.3 06.86 - 10.88 1.4 LX 01.89 - 08.91 1.5 06.86 - 10.88 1.6 i 06.86 - 10.90 1.6 06.86 - 10.88 1.6 i 12V 06.86 - 10.90 1.6 GTI 16V 06.87 - 05.89 1.8 GTI 16V 01.89 - 06.91 1.7 D 06.86 - 01.91		
Lenker, Radaufhängung / Track Control Arm		15599 54500-50A00 
1.6 i 06.86 - 10.90 1.6 06.86 - 10.88 1.6 i 12V 06.86 - 10.90 1.6 GTI 16V 06.87 - 05.89 1.8 GTI 16V 01.89 - 06.91 1.7 D 06.86 - 01.91		
Lenker, Radaufhängung / Track Control Arm		15601 54501-50A00 
1.3 06.86 - 10.88 1.4 LX 01.89 - 08.91 1.5 06.86 - 10.88 1.6 i 06.86 - 10.90 1.6 06.86 - 10.88 1.6 i 12V 06.86 - 10.90 1.6 GTI 16V 06.87 - 05.89 1.8 GTI 16V 01.89 - 06.91 1.7 D 06.86 - 01.91		
Trag-/Führungsgelenk / Support-/ Steering Link		11865 40160-50A00 
1.3 06.86 - 10.88 1.4 LX 01.89 - 08.91 1.5 06.86 - 10.88 1.6 i 06.86 - 10.90 1.6 06.86 - 10.88 1.6 i 12V 06.86 - 10.90 1.6 GTI 16V 06.87 - 05.89 1.8 GTI 16V 01.89 - 06.91 1.7 D 06.86 - 01.91		
Faltenbalgsatz, Lenkung / Bellow Kit, steering system		30145 48203-05F26 
1.3 06.86 - 10.88 1.4 LX 01.89 - 08.91 1.5 06.86 - 10.88 1.6 i 06.86 - 10.90 1.6 06.86 - 10.88 1.6 i 12V 06.86 - 10.90 1.6 GTI 16V 06.87 - 05.89 1.8 GTI 16V 01.89 - 06.91 1.7 D 06.86 - 01.91		
Faltenbalgsatz, Lenkung / Bellow Kit, steering system		30147 48204-53A00 
1.4 LX 01.89 - 08.91 1.6 i 06.86 - 10.90 1.6 06.86 - 10.88		
1.6 GTI 16V 06.87 - 05.89		
1.8 GTI 16V 01.89 - 06.91 1.7 D 06.86 - 01.91		
1.3 06.86 - 10.88		









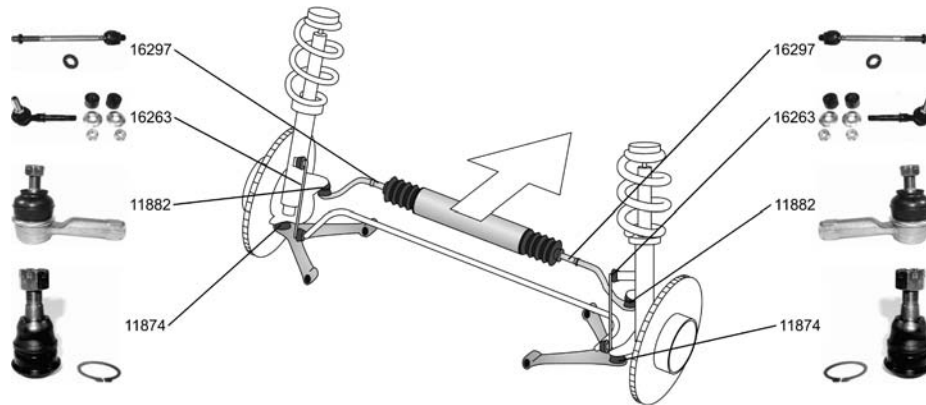

NISSAN

SUNNY III (N14)

10.90 - 12.95





<p>Spurstangenkopf / Tie-rod End Gewindeart: mit Rechtsgewinde / Thread Type: with right-hand thread Innengewinde [mm] / Inner Thread [mm]: M12x1,25</p> <p>ALL TYPES ausser/except for : 1.4 i 16V 10.90 - 06.95</p>		<p>11882 48520-02E26</p> 
<p>Axialgelenk, Spurstange / Axial Rod, tie rod</p> <p>1.4 i 10.90 - 05.95 1.6 i 10.90 - 05.95 1.6 i 16V 10.92 - 05.95 2.0 D 10.90 - 05.95</p>		<p>16297 48521-50Y25</p> 
<p>Trag-/Führungsgelenk / Support-/ Steering Link</p> <p>ALL TYPES ausser/except for : 1.4 i 16V 10.90 - 06.95</p>		<p>11874 40160-69Y10</p> 
<p>Stange/Strebe, Stabilisator / Rod/Strut, stabiliser Pendelstange / Suspension Rod</p> <p>ALL TYPES ausser/except for : 1.4 i 16V 10.90 - 06.95</p>		<p>16263 54618-50Y00</p> 

SUNNY III Liftback (N14)

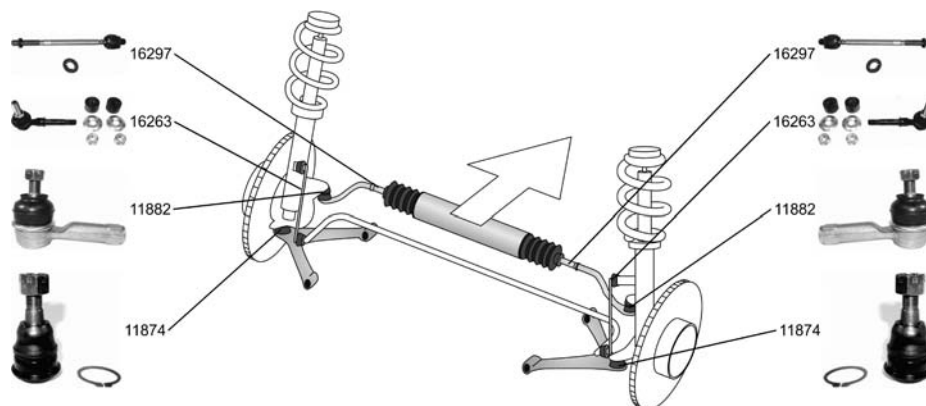
10.90 - 10.95



<p>Spurstangenkopf / Tie-rod End Gewindeart: mit Rechtsgewinde / Thread Type: with right-hand thread Innengewinde [mm] / Inner Thread [mm]: M12x1,25</p> <p>ALL TYPES ausser/except for : 1.4 i 16V 10.90 - 06.95</p>		<p>11882 48520-02E26</p> 
---	---	---









OE

NISSAN

SUNNY III Liftback (N14)

10.90 - 10.95

<p> Axialgelenk, Spurstange / Axial Rod, tie rod</p> <p>1.4 i 10.90 - 05.95 1.6 i 10.90 - 05.95 2.0 i 16V 10.90 - 05.95 2.0 D 10.90 - 05.95</p>		<p>16297 48521-50Y25</p> 
<p>Trag-/Führungsgelenk / Support-/ Steering Link</p> <p>ALL TYPES ausser/except for : 1.4 i 16V 10.90 - 06.95</p>		<p>11874 40160-69Y10</p> 
<p>Stange/Strebe, Stabilisator / Rod/Strut, stabiliser</p> <p>Pendelstange / Suspension Rod</p> <p>ALL TYPES ausser/except for : 1.4 i 16V 10.90 - 06.95</p>		<p>16263 54618-50Y00</p> 

SUNNY III Hatchback/avec hayon (N14)

10.90 - 07.95

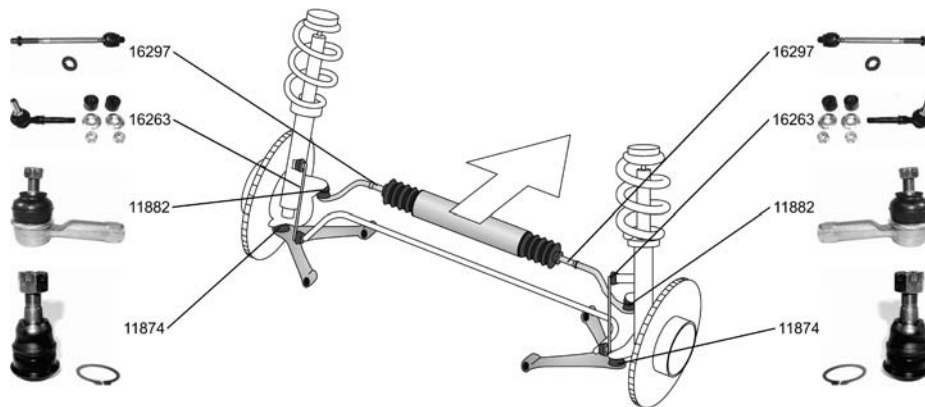

<p>Spurstangenkopf / Tie-rod End</p> <p>Gewindeart: mit Rechtsgewinde / Thread Type: with right-hand thread Innengewinde [mm] / Inner Thread [mm]: M12x1,25</p> <p>ALL TYPES ausser/except for : 1.6 i 4x4 02.91 - 09.92</p>		<p>11882 48520-02E26</p> 
<p>Axialgelenk, Spurstange / Axial Rod, tie rod</p> <p>1.4 i 10.90 - 05.95 1.6 i 10.90 - 05.95 2.0 GTI 16V 10.90 - 05.95 2.0 D 10.90 - 05.95</p>		<p>16297 48521-50Y25</p> 
<p>Trag-/Führungsgelenk / Support-/ Steering Link</p> <p>ALL TYPES ausser/except for : 1.6 i 4x4 02.91 - 09.92</p>		<p>11874 40160-69Y10</p> 
<p>Stange/Strebe, Stabilisator / Rod/Strut, stabiliser</p> <p>Pendelstange / Suspension Rod</p> <p>ALL TYPES ausser/except for : 1.6 i 4x4 02.91 - 09.92</p>		<p>16263 54618-50Y00</p> 









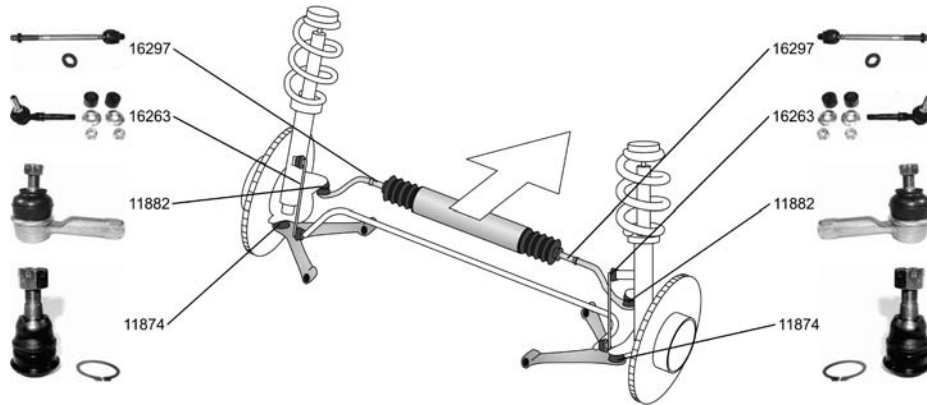

NISSAN

SUNNY III Traveller/Estate/Break (Y10)

11.90 -



Spurstangenkopf / Tie-rod End Gewindeart: mit Rechtsgewinde / Thread Type: with right-hand thread Innengewinde [mm] / Inner Thread [mm]: M12x1,25		11882 48520-02E26 
1.6 i 06.91 - 2.0 D 06.91 -		
Axialgelenk, Spurstange / Axial Rod, tie rod		16297 48521-50Y25 
1.6 i 06.91 - 2.0 D 06.91 -		
Trag-/Führungsgelenk / Support-/ Steering Link		11874 40160-69Y10 
1.6 i 06.91 - 1.6 16V 4x4 11.90 - 05.95 1.6 i 16V 4x4 10.92 - 2.0 D 06.91 -		
Stange/Strebe, Stabilisator / Rod/Strut, stabiliser Pendelstange / Suspension Rod		16263 54618-50Y00 
1.6 i 06.91 - 1.6 16V 4x4 11.90 - 05.95 1.6 i 16V 4x4 10.92 - 2.0 D 06.91 -		







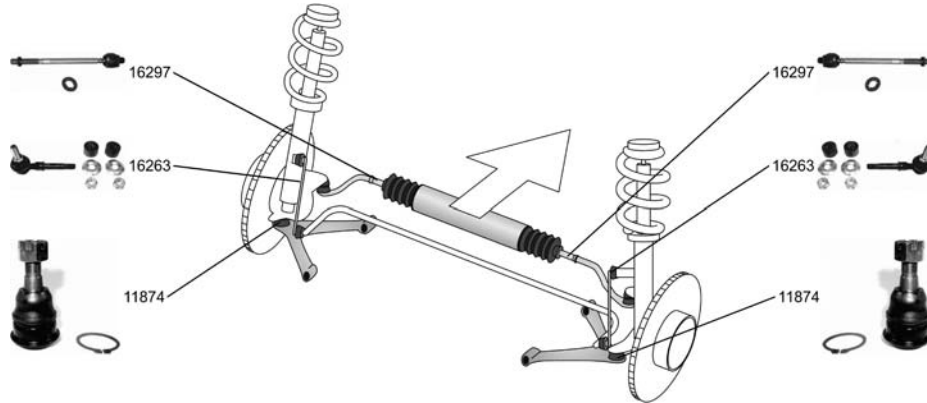

OE

NISSAN

SUNNY Kasten/Box/Furgón/Van (Y10)

11.90 -





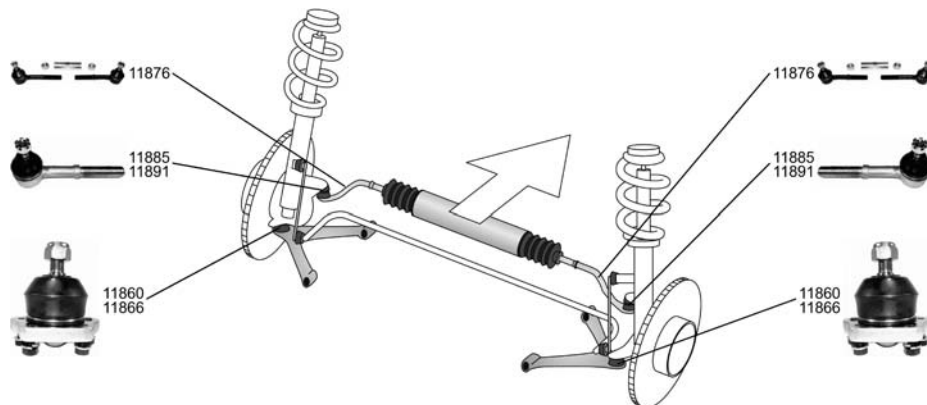

Axialgelenk, Spurstange / Axial Rod, tie rod ALL TYPES		16297 48521-50Y25
		
Trag-/Führungsgelenk / Support-/ Steering Link ALL TYPES		11874 40160-69Y10
		
Stange/Strebe, Stabilisator / Rod/Strut, stabiliser Pendelstange / Suspension Rod ALL TYPES		16263 54618-50Y00
		

TERRANO I (WD21)

07.86 - 02.96











Spurstange / Tie Rod, steering 2.4 i 4WD 10.87 - 02.93 3.0 i 4WD 01.90 - 12.95 2.7 TD 4WD 02.89 - 02.96		11876 48510-31G25 
Spurstangenkopf / Tie-rod End Gewindeart: mit Rechtsgewinde / Thread Type: with right-hand thread Aussengewinde [mm] / Outer Thread [mm]: M16x1,5 2.4 i 4WD 10.87 - 02.93 3.0 i 4WD 01.90 - 12.95 2.7 TD 4WD 02.89 - 02.96		11885 48520-61G25 



NISSAN

TERRANO I (WD21)







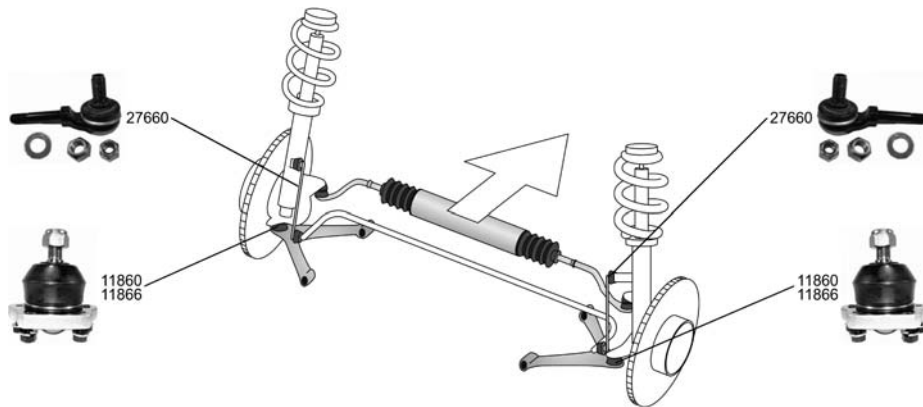

07.86 - 02.96

 Spurstangenkopf / Tie-rod End Gewindeart: mit Rechtsgewinde / Thread Type: with right-hand thread Aussengewinde [mm] / Outer Thread [mm]: M16x1,5		11891 48570-61G25 	
	2.4 i 4WD 10.87 - 02.93 3.0 i 4WD 01.90 - 12.95 2.7 TD 4WD 02.89 - 02.96		
	Trag-/Führungsgelenk / Support-/ Steering Link		11860 40110-01G26 
2.4 i 4WD 10.87 - 02.93 3.0 i 4WD 01.90 - 12.95 2.7 TD 4WD 02.89 - 02.96			
Trag-/Führungsgelenk / Support-/ Steering Link		11866 40160-93G25 	
2.4 i 4WD 10.87 - 02.93 3.0 i 4WD 01.90 - 12.95 2.7 TD 4WD 02.89 - 02.96			
Lenkzwischenhebel / Idler Arm		16250 48530-31G25 	
2.4 i 4WD 10.87 - 02.93 3.0 i 4WD 01.90 - 12.95 2.7 TD 4WD 02.89 - 02.96	->10.1993		

TERRANO II (R20)

02.93 -







Trag-/Führungsgelenk / Support-/ Steering Link ALL TYPES ausser/except for : 3.0 Di 4WD 05.02 -		11860 40110-01G26 
Trag-/Führungsgelenk / Support-/ Steering Link ALL TYPES ausser/except for : 3.0 Di 4WD 05.02 -		11866 40160-93G25 
Stange/Strebe, Stabilisator / Rod/Strut, stabiliser Pendelstange / Suspension Rod mit Zubehör / With accessories ALL TYPES		27660 54618-0F000 
 Stange/Strebe, Stabilisator / Rod/Strut, stabiliser ohne Zubehör / without accessories Koppelstange / Coupling Rod ALL TYPES		27988 56260-0F001 







OE

NISSAN











URVAN Bus/Familial (E23) 07.80 - 11.88

	Trag-/Führungsgelenk / Support-/ Steering Link		11860	40110-01G26
	2.0 (E23B) 2.3 D (E23B)	12.82 - 11.88 04.85 - 11.88		
	Trag-/Führungsgelenk / Support-/ Steering Link		11873	40161-48W25
	2.0 (E23B) 2.3 D (E23B)	12.82 - 11.88 04.85 - 11.88		

URVAN Kasten/Box/Furgón/Van (E23) 07.80 - 05.87

	Trag-/Führungsgelenk / Support-/ Steering Link		11860	40110-01G26
	ALL TYPES			
	Trag-/Führungsgelenk / Support-/ Steering Link		11873	40161-48W25
	ALL TYPES			

URVAN Bus/Familial (E24) 11.86 -





	Spurstange / Tie Rod, steering		16284	48510-01N25
	2.4 i 2.5 D	05.89 - 05.89 -		
	Spurstangenkopf / Tie-rod End Gewindemaß / Thread Size: M14x1,5 Gewindeart: mit Rechtsgewinde / Thread Type: with right-hand thread		16304	48520-27N25
	2.4 i 2.5 D	05.89 - 05.89 -		
	Spurstangenkopf / Tie-rod End Gewindeart: mit Rechtsgewinde / Thread Type: with right-hand thread Gewindemaß / Thread Size: M16x1,5		16307	48640-01N25
	2.4 i 2.5 D	05.89 - 05.89 -		
	Spurstangenkopf / Tie-rod End Gewindeart: mit Linksgewinde / Thread Type: With left-hand thread Gewindemaß / Thread Size: M16x1,5		16308	48641-01N25
	2.4 i 2.5 D	05.89 - 05.89 -		
	Axialgelenk, Spurstange / Axial Rod, tie rod		16296	48521-27N25
	2.4 i 2.5 D	05.89 - 05.89 -		



NISSAN















URVAN Bus/Familial (E24)

11.86 -

	Trag-/Führungsgelenk / Support-/ Steering Link			11860	40110-01G26
	2.4 i	05.89 -			
2.5 D	05.89 -				
	Trag-/Führungsgelenk / Support-/ Steering Link			11863	40160-01N25
	2.4 i	05.89 -			
2.5 D	05.89 -				

URVAN Kasten/Box/Furgón/Van (E24)

05.87 -





	Spurstange / Tie Rod, steering			16284	48510-01N25
	2.0	05.87 -			
	2.3 D	01.88 -			
2.5 D	12.88 -				
	Spurstangenkopf / Tie-rod End Gewindemaß / Thread Size: M14x1,5 Gewindeart: mit Rechtsgewinde / Thread Type: with right-hand thread			16304	48520-27N25
	2.0	05.87 -			
	2.3 D	01.88 -			
2.5 D	12.88 -				
	Spurstangenkopf / Tie-rod End Gewindeart: mit Rechtsgewinde / Thread Type: with right-hand thread Gewindemaß / Thread Size: M16x1,5			16307	48640-01N25
	2.0	05.87 -			
	2.3 D	01.88 -			
2.5 D	12.88 -				
	Spurstangenkopf / Tie-rod End Gewindeart: mit Linksgewinde / Thread Type: With left-hand thread Gewindemaß / Thread Size: M16x1,5			16308	48641-01N25
	2.0	05.87 -			
	2.3 D	01.88 -			
2.5 D	12.88 -				
	Axialgelenk, Spurstange / Axial Rod, tie rod			16296	48521-27N25
	2.0	05.87 -	10.1988->		
	2.3 D	01.88 -			
2.5 D	12.88 -				
	Trag-/Führungsgelenk / Support-/ Steering Link			11860	40110-01G26
	2.0	05.87 -			
	2.3 D	01.88 -			
2.5 D	12.88 -				
	Trag-/Führungsgelenk / Support-/ Steering Link			11863	40160-01N25
	2.0	05.87 -			
	2.3 D	01.88 -			
2.5 D	12.88 -				



OE









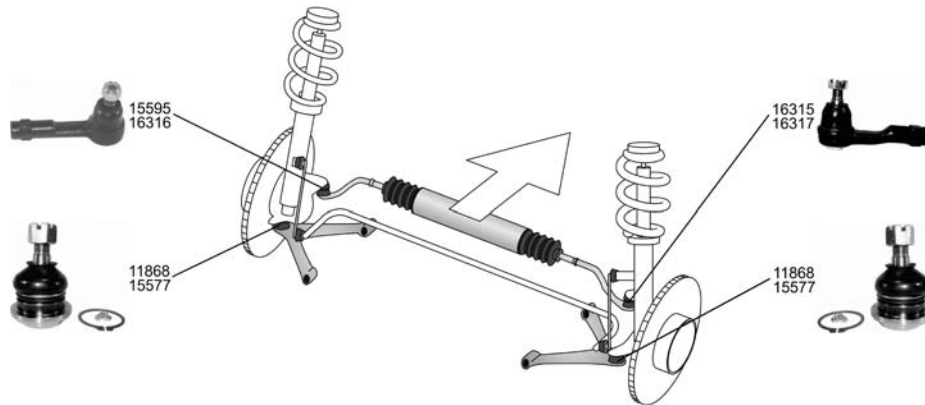

NISSAN

VANETTE Bus/Familial (KC120) 06.81 - 12.87

 Trag-/Führungsgelenk / Support-/ Steering Link Konusmaß [mm] / Cone Size [mm]: 13,5 1.5	01.83 - 12.87		11868 40160-G5400 
	01.83 - 12.87		
Trag-/Führungsgelenk / Support-/ Steering Link 1.5	01.83 - 12.87		15577 40110-G5110 

VANETTE Bus/Familial (C22) 10.86 - 12.95





Spurstangenkopf / Tie-rod End Gewindeart: mit Linksgewinde / Thread Type: With left-hand thread Gewindemaß / Thread Size: M14x1,5 2.4 i (SLC22) 2.0 D (ULC22)	10.86 - 12.95		15595 48641-G5125 
	10.86 - 12.95		
Spurstangenkopf / Tie-rod End Gewindeart: mit Rechtsgewinde / Thread Type: with right-hand thread Gewindemaß / Thread Size: M14x1,5 2.4 i (SLC22) 2.0 D (ULC22)	10.86 - 12.95		16315 48521-G5125 
	10.86 - 12.95		
Spurstangenkopf / Tie-rod End Gewindeart: mit Rechtsgewinde / Thread Type: with right-hand thread Innengewinde [mm] / Inner Thread [mm]: M14x1,5 2.4 i (SLC22) 2.0 D (ULC22)	10.86 - 12.95		16316 48640-G5125 
	10.86 - 12.95		
Spurstangenkopf / Tie-rod End Gewindeart: mit Linksgewinde / Thread Type: With left-hand thread Innengewinde [mm] / Inner Thread [mm]: M14x1,5 2.4 i (SLC22) 2.0 D (ULC22)	10.86 - 12.95		16317 48520-G5125 
	10.86 - 12.95		
Trag-/Führungsgelenk / Support-/ Steering Link Konusmaß [mm] / Cone Size [mm]: 13,5 2.4 i (SLC22) 2.0 D (ULC22)	10.86 - 12.95		11868 40160-G5400 
	10.86 - 12.95		



NISSAN

VANETTE Bus/Familial (C22) 10.86 - 12.95

	Trag-/Führungsgelenk / Support-/ Steering Link		15577 40110-G5110
	2.4 i (SLC22) 2.0 D (ULC22)	10.86 - 12.95 10.86 - 12.95	

VANETTE Kasten/Box/Furgón/Van (C22) 10.86 - 01.95

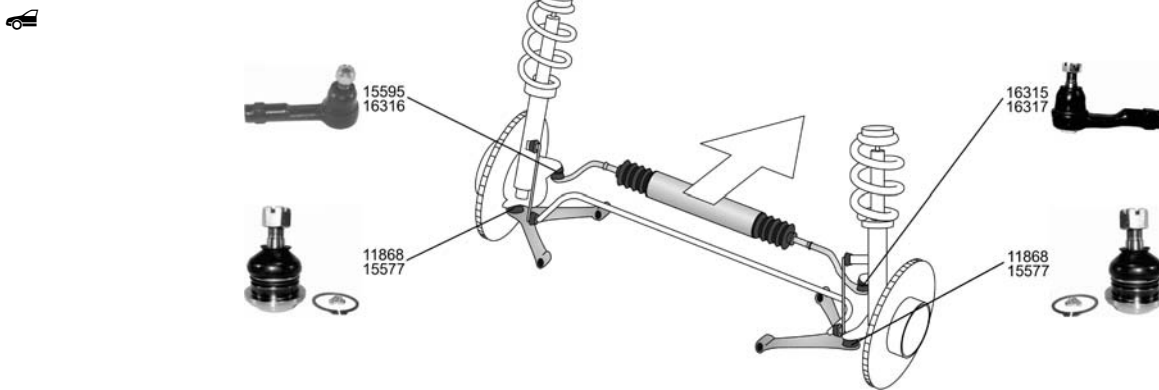

	Spurstangenkopf / Tie-rod End Gewindeart: mit Linksgewinde / Thread Type: With left-hand thread Gewindemaß / Thread Size: M14x1,5		15595 48641-G5125
	2.0 D	07.91 - 01.95	
	Spurstangenkopf / Tie-rod End Gewindeart: mit Rechtsgewinde / Thread Type: with right-hand thread Gewindemaß / Thread Size: M14x1,5		16315 48521-G5125
	2.0 D	07.91 - 01.95	
	Spurstangenkopf / Tie-rod End Gewindeart: mit Rechtsgewinde / Thread Type: with right-hand thread Innengewinde [mm] / Inner Thread [mm]: M14x1,5		16316 48640-G5125
	2.0 D	07.91 - 01.95	
	Spurstangenkopf / Tie-rod End Gewindeart: mit Linksgewinde / Thread Type: With left-hand thread Innengewinde [mm] / Inner Thread [mm]: M14x1,5		16317 48520-G5125
	2.0 D	07.91 - 01.95	
	Trag-/Führungsgelenk / Support-/ Steering Link Konusmaß [mm] / Cone Size [mm]: 13,5		11868 40160-G5400
	2.0 D	07.91 - 01.95	
	Trag-/Führungsgelenk / Support-/ Steering Link		15577 40110-G5110
	2.0 D	07.91 - 01.95	











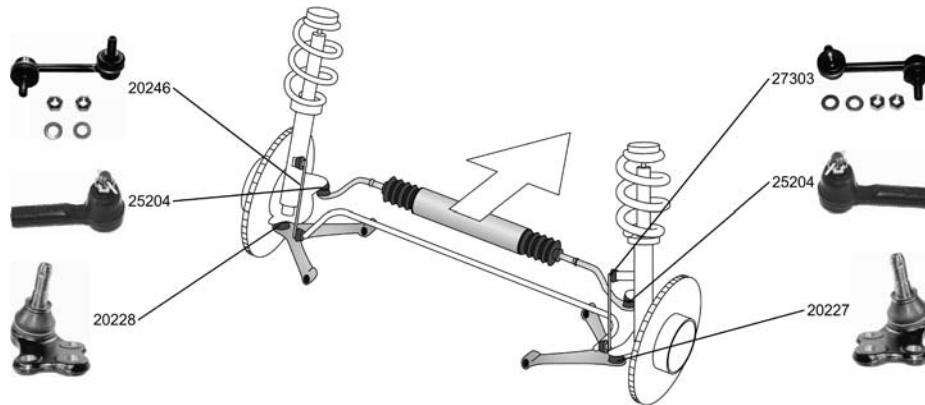

OE

NISSAN

VANETTE CARGO Bus (HC 23)

01.96 -



Spurstangenkopf / Tie-rod End ALL TYPES		25204 48520-73J25
ALL TYPES		
Trag-/Führungsgelenk / Support-/ Steering Link mit Zubehör / With accessories ALL TYPES		20227 40160-9C500
ALL TYPES		
Trag-/Führungsgelenk / Support-/ Steering Link mit Zubehör / With accessories ALL TYPES		20228 40161-9C500
ALL TYPES		
Stange/Strebe, Stabilisator / Rod/Strut, stabiliser Pendelstange / Suspension Rod ALL TYPES		20246 54668-9C000
ALL TYPES		
Stange/Strebe, Stabilisator / Rod/Strut, stabiliser Pendelstange / Suspension Rod mit Zubehör / With accessories ALL TYPES		27303 54618-9C002
ALL TYPES		











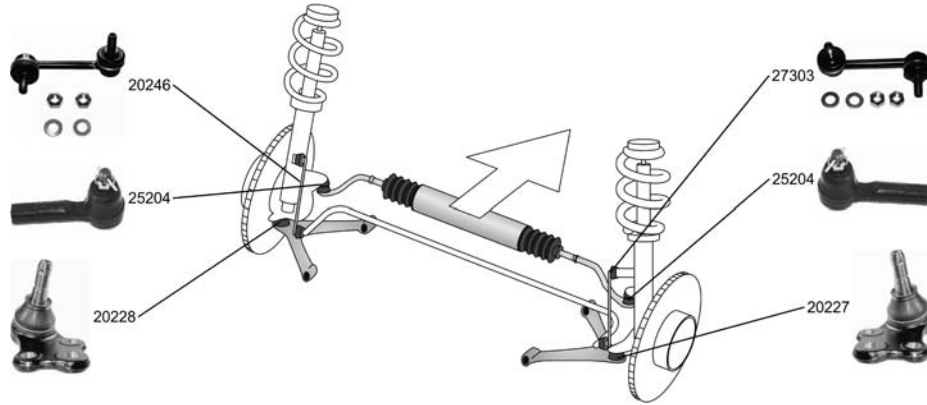

NISSAN

VANETTE CARGO

01.95 -

Kasten/Box/Furgón/Van (HC 23)



Spurstangenkopf / Tie-rod End			25204	48520-73J25
1.6 i	01.95 -			
2.0 D	01.95 -			
2.3 D	01.95 -			
Trag-/Führungsgelenk / Support-/ Steering Link mit Zubehör / With accessories			20227	40160-9C500
1.6 i	01.95 -			
2.0 D	01.95 -			
2.3 D	01.95 -			
Trag-/Führungsgelenk / Support-/ Steering Link mit Zubehör / With accessories			20228	40161-9C500
1.6 i	01.95 -			
2.0 D	01.95 -			
2.3 D	01.95 -			
Stange/Strebe, Stabilisator / Rod/Strut, stabiliser			20246	54668-9C000
Pendelstange / Suspension Rod				
1.6 i	01.95 -			
2.0 D	01.95 -			
2.3 D	01.95 -			
Stange/Strebe, Stabilisator / Rod/Strut, stabiliser			27303	54618-9C002
Pendelstange / Suspension Rod mit Zubehör / With accessories				
1.6 i	01.95 -			
2.0 D	01.95 -			
2.3 D	01.95 -			

Artikelnummer Article No.	Seite Page	Hersteller Manufacturer	Artikelnummer Article No.	Seite Page	Hersteller Manufacturer
11860	13 14 40	NISSAN	15579	10	NISSAN
Trag-/Führungsgelenk / Support-/ Steering Link	41 42		Trag-/Führungsgelenk / Support-/ Steering Link		
11862	4 5 6	NISSAN	15586	7 27 28	NISSAN
Trag-/Führungsgelenk / Support-/ Steering Link	7 10 11 15 16 22		Spurstange / Tie Rod, steering	29 30 32 34	
11863	42	NISSAN	15589	11	NISSAN
Trag-/Führungsgelenk / Support-/ Steering Link			Spurstangenkopf / Tie-rod End		
11865	30 31 33	NISSAN	15591	11	NISSAN
Trag-/Führungsgelenk / Support-/ Steering Link	35		Axialgelenk, Spurstange / Axial Rod, tie rod		
11866	15 40	NISSAN	15592	2 10	NISSAN
Trag-/Führungsgelenk / Support-/ Steering Link			Axialgelenk, Spurstange / Axial Rod, tie rod		
11868	43 44	NISSAN	15595	43 44	NISSAN
Trag-/Führungsgelenk / Support-/ Steering Link			Spurstangenkopf / Tie-rod End		
11873	13 41	NISSAN	15599	30 31 33 35	NISSAN
Trag-/Führungsgelenk / Support-/ Steering Link			Lenker, Radaufhängung / Track Control Arm		
11874	2 3 36	NISSAN	15600	1	NISSAN
Trag-/Führungsgelenk / Support-/ Steering Link	37 38 39		Lenker, Radaufhängung / Track Control Arm		
11875	14	NISSAN	15601	30 31 33 35	NISSAN
Spurstange / Tie Rod, steering			Lenker, Radaufhängung / Track Control Arm		
11876	14 39	NISSAN	15602	1	NISSAN
Spurstange / Tie Rod, steering			Lenker, Radaufhängung / Track Control Arm		
11880	1 4 5	NISSAN	16250	15 40	NISSAN
Axialgelenk, Spurstange / Axial Rod, tie rod	6 7 11 15 16 27 28 29 31 32 34		Lenkzwischenhebel / Idler Arm		
11882	1 4 5	NISSAN	16263	1 2 3	NISSAN
Spurstangenkopf / Tie-rod End	6 21 36 37 38		Stange/Strebe, Stabilisator / Rod/Strut, stabiliser	19 21 22 36 37 38 39	
11883	14	NISSAN	16284	41 42	NISSAN
Spurstangenkopf / Tie-rod End			Spurstange / Tie Rod, steering		
11885	14 39	NISSAN	16285	29 31 32 34	NISSAN
Spurstangenkopf / Tie-rod End			Spurstange / Tie Rod, steering		
11886	10	NISSAN	16296	41 42	NISSAN
Spurstangenkopf / Tie-rod End			Axialgelenk, Spurstange / Axial Rod, tie rod		
11887	4 5 6	NISSAN	16297	1 3 22	NISSAN
Spurstangenkopf / Tie-rod End	29 31 32 34		Axialgelenk, Spurstange / Axial Rod, tie rod	36 37 38 39	
11891	14 40	NISSAN	16298	10 15 16 19 20	NISSAN
Spurstangenkopf / Tie-rod End			Axialgelenk, Spurstange / Axial Rod, tie rod		
15577	43 44	NISSAN	16301	28 29 30 31 33 35	NISSAN
Trag-/Führungsgelenk / Support-/ Steering Link			Axialgelenk, Spurstange / Axial Rod, tie rod		

Arithmetische Liste / Part number list

Artikelnummer Article No.	Seite Page	Hersteller Manufacturer	Artikelnummer Article No.	Seite Page	Hersteller Manufacturer
16304 ♂	41 42	NISSAN	25200 ♂	13 15	NISSAN
Spurstangenkopf / Tie-rod End			Spurstangenkopf / Tie-rod End		
16307 ♂	41 42	NISSAN	25201 ♂	13 15	NISSAN
Spurstangenkopf / Tie-rod End			Spurstangenkopf / Tie-rod End		
16308 ♂	41 42	NISSAN	25202 ♂	20 21 22	NISSAN
Spurstangenkopf / Tie-rod End			Stange/Strebe, Stabilisator / Rod/Strut, stabiliser		
16309 ♂	16	NISSAN	25204 ♂	19 20 21	NISSAN
Spurstangenkopf / Tie-rod End			Spurstangenkopf / Tie-rod End	23 24 25	
16315 ♂	43 44	NISSAN		26 27 45	
Spurstangenkopf / Tie-rod End				46	
16316 ♂	43 44	NISSAN	25510 ♂	17 18	NISSAN
Spurstangenkopf / Tie-rod End			Spurstangenkopf / Tie-rod End		
16317 ♂	43 44	NISSAN	25511 ♂	17 18	NISSAN
Spurstangenkopf / Tie-rod End			Spurstangenkopf / Tie-rod End		
20227 ▽	27 45 46	NISSAN	25513 ♂	17 18	NISSAN
Trag-/Führungsgelenk / Support-/ Steering Link			Stange/Strebe, Stabilisator / Rod/Strut, stabiliser		
20228 ▽	27 45 46	NISSAN	25814 ♂	8 9	NISSAN
Trag-/Führungsgelenk / Support-/ Steering Link			Stange/Strebe, Stabilisator / Rod/Strut, stabiliser		
20246 ♂	27 45 46	NISSAN	25815 ♂	8 9	NISSAN
Stange/Strebe, Stabilisator / Rod/Strut, stabiliser			Stange/Strebe, Stabilisator / Rod/Strut, stabiliser		
21196 ▽	19 20 22	NISSAN	26706 ♂	8 9	NISSAN
Trag-/Führungsgelenk / Support-/ Steering Link	23 24 25		Axialgelenk, Spurstange / Axial Rod, tie rod		
22674 ▽	12	NISSAN	26712 ♂	8 9	NISSAN
Trag-/Führungsgelenk / Support-/ Steering Link			Spurstange / Tie Rod, steering		
22676 ▽	19 21	NISSAN	26713 ♂	8 9	NISSAN
Trag-/Führungsgelenk / Support-/ Steering Link			Spurstangenkopf / Tie-rod End		
22679 ▽	12	NISSAN	26938 ▽	17 18	NISSAN
Spurstangenkopf / Tie-rod End			Lagerung, Lenker / Mounting, wishbone		
22686 ♂	10	NISSAN	26939 ▽	17 18	NISSAN
Spurstangenkopf / Tie-rod End			Lagerung, Lenker / Mounting, wishbone		
22687 ♂	2 3	NISSAN	27219 ▽	17 18	NISSAN
Axialgelenk, Spurstange / Axial Rod, tie rod			Trag-/Führungsgelenk / Support-/ Steering Link		
24666 ▲	19 20 22	NISSAN	27303 ♂	27 45 46	NISSAN
Lenker, Radaufhängung / Track Control Arm	23 24 25		Stange/Strebe, Stabilisator / Rod/Strut, stabiliser		
24667 ▲	19 20 22	NISSAN	27660 ♂	40	NISSAN
Lenker, Radaufhängung / Track Control Arm	23 24 25		Stange/Strebe, Stabilisator / Rod/Strut, stabiliser		
25190 ♂	12	NISSAN	27719 ▲	8 9	NISSAN
Stange/Strebe, Stabilisator / Rod/Strut, stabiliser			Trag-/Führungsgelenk / Support-/ Steering Link		
			27720 ▽	8 9	NISSAN
			Trag-/Führungsgelenk / Support-/ Steering Link		

Artikelnummer Article No.	Seite Page	Hersteller Manufacturer	Artikelnummer Article No.	Seite Page	Hersteller Manufacturer
27988 ☺	40	NISSAN			
Stange/Strebe, Stabilisator / Rod/Strut, stabiliser					
28675 ☺	19 22 23 24 25	NISSAN			
Stange/Strebe, Stabilisator / Rod/Strut, stabiliser					
29410 ▽☺Ⓢ	12	NISSAN			
Lagerung, Lenker / Mounting, wishbone					
29411 ▽☺Ⓢ	13	NISSAN			
Lagerung, Lenker / Mounting, wishbone					
29468 ☺	13	NISSAN			
Stange/Strebe, Stabilisator / Rod/Strut, stabiliser					
29469	12	NISSAN			
29699 ▽☺	12	NISSAN			
Lenker, Radaufhängung / Track Control Arm					
29700 ▽☺	12	NISSAN			
Lenker, Radaufhängung / Track Control Arm					
30109 ☺	4 5 7 11	NISSAN			
Faltenbalgsatz, Lenkung / Bellow Kit, steering system					
30145 ☺	4 5 6 7 28 29 30 31 33 35	NISSAN			
Faltenbalgsatz, Lenkung / Bellow Kit, steering system					
30146 ☺	4 16	NISSAN			
Faltenbalgsatz, Lenkung / Bellow Kit, steering system					
30147 ☺	28 29 30 31 33 35	NISSAN			
Faltenbalgsatz, Lenkung / Bellow Kit, steering system					
30174 ☺	2 5 6 7 10 16 19 21 22	NISSAN			
Faltenbalgsatz, Lenkung / Bellow Kit, steering system					
30196 ☺	20 21 23 24	NISSAN			
Faltenbalgsatz, Lenkung / Bellow Kit, steering system					
30199 ☺	2 3	NISSAN			
Faltenbalgsatz, Lenkung / Bellow Kit, steering system					
30200 ☺	2 3	NISSAN			
Faltenbalgsatz, Lenkung / Bellow Kit, steering system					
30228	9	NISSAN			
Faltenbalgsatz, Lenkung / Bellow Kit, steering system					
30246 ☺	12	NISSAN			
Faltenbalgsatz, Lenkung / Bellow Kit, steering system					

Vergleichsliste / Cross reference list

Vergleichs-Nr. Compare No.	Artikelnummer Article No.	Vergleichs-Nr. Compare No.	Artikelnummer Article No.	Vergleichs-Nr. Compare No.	Artikelnummer Article No.
NISSAN		NISSAN			
40110-01G26	11860	48640-G5125	16316		
40110-G5110	15577	48641-01N25	16308		
40160-000AD	27720	48641-G5125	15595		
40160-00QAB	27719	54500-50A00	15599		
40160-01N25	11863	54500-52Y10	15600		
40160-4F100	22674	54501-50A00	15601		
40160-50A00	11865	54501-52Y10	15602		
40160-67L00	15579	54524-2F010	24666		
40160-69Y10	11874	54525-2F010	24667		
40160-70J00	22676	54560-AX600	29410		
40160-85E00	11862	54570-AX600	29411		
40160-93G25	11866	54616- 00QAB	25814		
40160-9C500	20227	54616-00QAC	25513		
40160-G5400	11868	54618-00QAA	25815		
40161-48W25	11873	54618-0F000	27660		
40161-9C500	20228	54618-50J20	28675		
48203-05F26	30145	54618-50Y00	16263		
48203-0E025	30199	54618-9C002	27303		
48203-10V25	30174	54618-AX600	29468		
48203-41B27	30200	54668-9C000	20246		
48203-6F610	30246	56260-0F001	27988		
48203-Q9025	30196	56261-4F725	25190		
48204-04A01	30109	56261-90J01	25202		
48204-42L25	30146				
48204-53A00	30147				
48510-01G25	11875				
48510-01N25	16284				
48510-31G25	11876				
48510-53A26	16285				
48510-70A27	15586				
48520-00QAH	26712				
48520-00QAJ	26713				
48520-00QAK	25510				
48520-00QAL	25511				
48520-01G25	11883				
48520-02E26	11882				
48520-17B25	15589				
48520-27N25	16304				
48520-41L27	11886				
48520-4F125	22679				
48520-50A26	11887				
48520-53E25	16309				
48520-61G25	11885				
48520-73J25	25204				
48520-88E25	22686				
48520-G5125	16317				
48521-00QAF	26706				
48521-01F00	15592				
48521-17B25	15591				
48521-1M226	22687				
48521-27N25	16296				
48521-35A06	16301				
48521-50Y25	16297				
48521-70A06	11880				
48521-72E06	16298				
48521-G5125	16315				
48530-31G25	16250				
48570-61G25	11891				
48570-82100	25200				
48580-82100	25201				
48640-01N25	16307				

Neuaufnahmen / New to range

Artikelnummer Article No.	Seite Page	Hersteller Manufacturer
11860	13 14 40 41 42	NISSAN
11863	42	NISSAN
11866	15 40	NISSAN
11873	13 41	NISSAN
11880	1 4 5 6 7 11 15 16 27 28 29 31 32 34	NISSAN
11883	14	NISSAN
11886	10	NISSAN
15577	43 44	NISSAN
15586	7 27 28 29 30 32 34	NISSAN
15591	11	NISSAN
15592	2 10	NISSAN
15600	1	NISSAN
15602	1	NISSAN
16250	15 40	NISSAN
16285	29 31 32 34	NISSAN
16296	41 42	NISSAN
16298	10 15 16 19 20	NISSAN
16301	28 29 30 31 33 35	NISSAN
16304	41 42	NISSAN
16307	41 42	NISSAN
16308	41 42	NISSAN
20227	27 45 46	NISSAN
20228	27 45 46	NISSAN
20246	27 45 46	NISSAN
21196	19 20 22 23 24 25	NISSAN
22674	12	NISSAN
22676	19 21	NISSAN
22679	12	NISSAN
22686	10	NISSAN
22687	2 3	NISSAN
24666	19 20 22 23 24 25	NISSAN
24667	19 20 22 23 24 25	NISSAN
25190	12	NISSAN
25200	13 15	NISSAN
25201	13 15	NISSAN
25202	20 21 22	NISSAN
25204	19 20 21 23 24 25 26 27 45 46	NISSAN
25510	17 18	NISSAN
25511	17 18	NISSAN
25513	17 18	NISSAN
25814	8 9	NISSAN
25815	8 9	NISSAN
26706	8 9	NISSAN
26712	8 9	NISSAN
26713	8 9	NISSAN
27219	17 18	NISSAN
27303	27 45 46	NISSAN

Artikelnummer Article No.	Seite Page	Hersteller Manufacturer
27660	40	NISSAN
27719	8 9	NISSAN
27720	8 9	NISSAN
27988	40	NISSAN
28675	19 22 23 24 25	NISSAN
29410	12	NISSAN
29411	13	NISSAN
29468	13	NISSAN
29469	12	NISSAN
29699	12	NISSAN
29700	12	NISSAN
30109	4 5 7 11	NISSAN
30145	4 5 6 7 28 29 30 31 33 35	NISSAN
30146	4 16	NISSAN
30147	28 29 30 31 33 35	NISSAN
30174	2 5 6 7 10 16 19 21 22	NISSAN
30196	20 21 23 24	NISSAN
30199	2 3	NISSAN
30200	2 3	NISSAN
30228	9	NISSAN
30246	12	NISSAN

Geänderte Bestellnummer / Amended part numbers

Artikelnummer alt Article No. old	Artikelnummer neu Article No. new	Artikelnummer alt Article No. old	Artikelnummer neu Article No. new	Artikelnummer alt Article No. old	Artikelnummer neu Article No. new
15580	30109				
15581	30145				
15582	30109				
15584	30146				
15585	30147				
20239	30174				
22673	11866				
22675	11874				
29412	29469				

Geänderte Bestellnummer / Amended part numbers

Artikelnummer neu Article No. new	Artikelnummer alt Article No. old	Artikelnummer neu Article No. new	Artikelnummer alt Article No. old	Artikelnummer neu Article No. new	Artikelnummer alt Article No. old
11866	22673				
11874	22675				
29469	29412				
30109	15580				
30109	15582				
30145	15581				
30146	15584				
30147	15585				
30174	20239				