











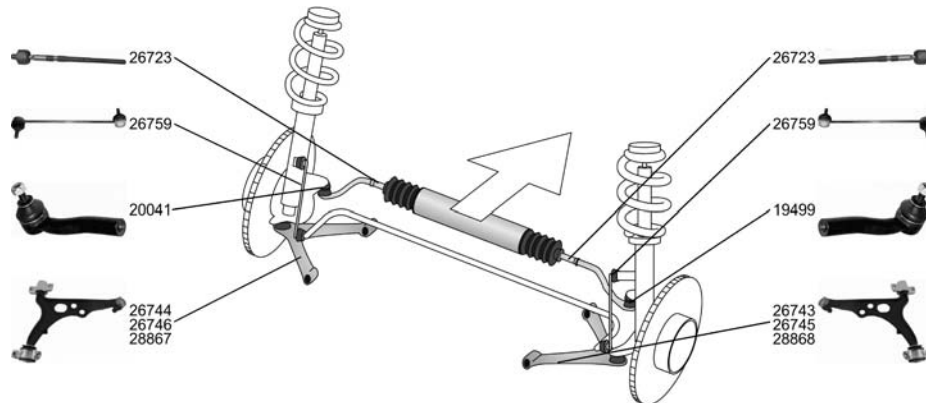

OE

**LANCIA**

**DEDRA (835)**

**01.89 - 07.99**











<p><b>Spurstangenkopf / Tie-rod End</b>                      Gewindeart: mit Rechtsgewinde / Thread Type: with right-hand thread                      Gewindemaß / Thread Size:M12x1,5                      ALL TYPES ausser/except for :                      2.0 16V 4WD 07.94 - 07.99</p>		<p><b>19499</b> 7 591 215</p> 
<p><b>Spurstangenkopf / Tie-rod End</b>                      Gewindemaß / Thread Size:M12x1,5                      Gewindeart: mit Rechtsgewinde / Thread Type: with right-hand thread                      Innengewinde [mm] / Inner Thread [mm]:M12x1,5                      ALL TYPES ausser/except for :                      2.0 16V 4WD 07.94 - 07.99</p>		<p><b>20041</b> 7 591 216</p> 
<p><b>Axialgelenk, Spurstange / Axial Rod, tie rod</b>                      Aussengewinde [mm] / Outer Thread [mm]:M14x1,5                      Aussengewinde [mm] / Outer Thread [mm]:M12x1,5                      1.6 i.e. (835AN) 04.93 - 07.99                      1.6 i.e. (835AB) 08.89 - 03.93                      1.6 i.e. (835AA) 08.89 - 06.94                      1.6 LE (835EB) KAT 07.94 - 07.99                      1.8 i.e. (835AT) 08.93 - 07.99                      1.8 i.e. (835FA) 07.94 - 07.99                      1.8 i.e. (835BD, 835AD) 09.89 - 07.99                      1.8 i.e. (835AC, 835BC) 09.89 - 06.94                      2.0 i.e. (835AL) 09.89 - 07.99                      2.0 i.e. (835AI) 09.89 - 07.92                      2.0 i.e. Turbo (835AR) 04.91 - 07.99                      2.0 Turbo (835AQ) 11.90 - 06.94                      1.9 TDS (835EE, 835EF) 04.89 - 07.99</p>		<p><b>26723</b> 9 941 625</p> 
<p><b>Lenker, Radaufhängung / Track Control Arm</b>                      1.6 i.e. (835AB) 08.89 - 03.93                      1.6 i.e. (835AA) 08.89 - 06.94                      1.8 i.e. (835BD, 835AD) 09.89 - 07.99                      1.8 i.e. (835AC, 835BC) 09.89 - 06.94                      2.0 i.e. (835AL) 09.89 - 07.99                      2.0 i.e. (835AI) 09.89 - 07.92                      1.9 TDS (835EE, 835EF) 04.89 - 07.99</p>	 <p>-&gt;07.1990</p>	<p><b>26743</b> 76 010 373</p> 
<p><b>Lenker, Radaufhängung / Track Control Arm</b>                      1.6 i.e. (835AB) 08.89 - 03.93                      1.6 i.e. (835AA) 08.89 - 06.94                      1.8 i.e. (835BD, 835AD) 09.89 - 07.99                      1.8 i.e. (835AC, 835BC) 09.89 - 06.94                      2.0 i.e. (835AL) 09.89 - 07.99                      2.0 i.e. (835AI) 09.89 - 07.92                      1.9 TDS (835EE, 835EF) 04.89 - 07.99</p>	 <p>-&gt;07.1990</p>	<p><b>26744</b> 76 010 372</p> 



# LANCIA

## DEDRA (835)

01.89 - 07.99

	<b>Lenker, Radaufhängung / Track Control Arm</b>		<b>26745</b>																																							
	<table border="0"> <tr><td>1.6 i.e. (835AN)</td><td>04.93 - 07.99</td></tr> <tr><td>1.6 LE (835EB) KAT</td><td>07.94 - 07.99</td></tr> <tr><td>1.6 16V (835EI)</td><td>01.96 - 07.99</td></tr> <tr><td>1.8 16V LE (835FG)</td><td>03.96 - 07.99</td></tr> <tr><td>1.8 GT 16V (835EH)</td><td>03.96 - 07.99</td></tr> <tr><td>1.8 i.e. (835AT)</td><td>08.93 - 07.99</td></tr> <tr><td>1.8 i.e. (835FA)</td><td>07.94 - 07.99</td></tr> <tr><td>1.8 i.e. (835BD, 835AD)</td><td>09.89 - 07.99</td></tr> <tr><td>1.8 i.e. (835AC, 835BC)</td><td>09.89 - 06.94</td></tr> <tr><td>2.0 i.e. (835AL)</td><td>09.89 - 07.99</td></tr> <tr><td>2.0 i.e. (835AI)</td><td>09.89 - 07.92</td></tr> <tr><td>2.0 16V (835ED)</td><td>07.94 - 07.99</td></tr> <tr><td>2.0 i.e. Turbo (835AR)</td><td>04.91 - 07.99</td></tr> <tr><td>2.0 i.e. Turbo Integrale (835AO)</td><td>05.90 - 07.94</td></tr> <tr><td>2.0 HF Integrale (835AP)</td><td>11.90 - 07.94</td></tr> <tr><td>2.0 Turbo (835AQ)</td><td>11.90 - 06.94</td></tr> <tr><td>1.9 TDS (835EE, 835EF)</td><td>04.89 - 07.99</td></tr> <tr><td>1.6 i.e. (835AB)</td><td>08.89 - 03.93</td></tr> <tr><td>1.6 i.e. (835AA)</td><td>08.89 - 06.94</td></tr> </table>	1.6 i.e. (835AN)	04.93 - 07.99	1.6 LE (835EB) KAT	07.94 - 07.99	1.6 16V (835EI)	01.96 - 07.99	1.8 16V LE (835FG)	03.96 - 07.99	1.8 GT 16V (835EH)	03.96 - 07.99	1.8 i.e. (835AT)	08.93 - 07.99	1.8 i.e. (835FA)	07.94 - 07.99	1.8 i.e. (835BD, 835AD)	09.89 - 07.99	1.8 i.e. (835AC, 835BC)	09.89 - 06.94	2.0 i.e. (835AL)	09.89 - 07.99	2.0 i.e. (835AI)	09.89 - 07.92	2.0 16V (835ED)	07.94 - 07.99	2.0 i.e. Turbo (835AR)	04.91 - 07.99	2.0 i.e. Turbo Integrale (835AO)	05.90 - 07.94	2.0 HF Integrale (835AP)	11.90 - 07.94	2.0 Turbo (835AQ)	11.90 - 06.94	1.9 TDS (835EE, 835EF)	04.89 - 07.99	1.6 i.e. (835AB)	08.89 - 03.93	1.6 i.e. (835AA)	08.89 - 06.94	07.1990->		
1.6 i.e. (835AN)	04.93 - 07.99																																									
1.6 LE (835EB) KAT	07.94 - 07.99																																									
1.6 16V (835EI)	01.96 - 07.99																																									
1.8 16V LE (835FG)	03.96 - 07.99																																									
1.8 GT 16V (835EH)	03.96 - 07.99																																									
1.8 i.e. (835AT)	08.93 - 07.99																																									
1.8 i.e. (835FA)	07.94 - 07.99																																									
1.8 i.e. (835BD, 835AD)	09.89 - 07.99																																									
1.8 i.e. (835AC, 835BC)	09.89 - 06.94																																									
2.0 i.e. (835AL)	09.89 - 07.99																																									
2.0 i.e. (835AI)	09.89 - 07.92																																									
2.0 16V (835ED)	07.94 - 07.99																																									
2.0 i.e. Turbo (835AR)	04.91 - 07.99																																									
2.0 i.e. Turbo Integrale (835AO)	05.90 - 07.94																																									
2.0 HF Integrale (835AP)	11.90 - 07.94																																									
2.0 Turbo (835AQ)	11.90 - 06.94																																									
1.9 TDS (835EE, 835EF)	04.89 - 07.99																																									
1.6 i.e. (835AB)	08.89 - 03.93																																									
1.6 i.e. (835AA)	08.89 - 06.94																																									
	<b>Lenker, Radaufhängung / Track Control Arm</b>		<b>26746</b>																																							
	<table border="0"> <tr><td>1.6 i.e. (835AN)</td><td>04.93 - 07.99</td></tr> <tr><td>1.6 LE (835EB) KAT</td><td>07.94 - 07.99</td></tr> <tr><td>1.6 16V (835EI)</td><td>01.96 - 07.99</td></tr> <tr><td>1.8 16V LE (835FG)</td><td>03.96 - 07.99</td></tr> <tr><td>1.8 GT 16V (835EH)</td><td>03.96 - 07.99</td></tr> <tr><td>1.8 i.e. (835AT)</td><td>08.93 - 07.99</td></tr> <tr><td>1.8 i.e. (835FA)</td><td>07.94 - 07.99</td></tr> <tr><td>1.8 i.e. (835BD, 835AD)</td><td>09.89 - 07.99</td></tr> <tr><td>1.8 i.e. (835AC, 835BC)</td><td>09.89 - 06.94</td></tr> <tr><td>2.0 i.e. (835AL)</td><td>09.89 - 07.99</td></tr> <tr><td>2.0 i.e. (835AI)</td><td>09.89 - 07.92</td></tr> <tr><td>2.0 16V (835ED)</td><td>07.94 - 07.99</td></tr> <tr><td>2.0 i.e. Turbo (835AR)</td><td>04.91 - 07.99</td></tr> <tr><td>2.0 i.e. Turbo Integrale (835AO)</td><td>05.90 - 07.94</td></tr> <tr><td>2.0 HF Integrale (835AP)</td><td>11.90 - 07.94</td></tr> <tr><td>2.0 Turbo (835AQ)</td><td>11.90 - 06.94</td></tr> <tr><td>1.9 TDS (835EE, 835EF)</td><td>04.89 - 07.99</td></tr> <tr><td>1.6 i.e. (835AB)</td><td>08.89 - 03.93</td></tr> <tr><td>1.6 i.e. (835AA)</td><td>08.89 - 06.94</td></tr> </table>	1.6 i.e. (835AN)	04.93 - 07.99	1.6 LE (835EB) KAT	07.94 - 07.99	1.6 16V (835EI)	01.96 - 07.99	1.8 16V LE (835FG)	03.96 - 07.99	1.8 GT 16V (835EH)	03.96 - 07.99	1.8 i.e. (835AT)	08.93 - 07.99	1.8 i.e. (835FA)	07.94 - 07.99	1.8 i.e. (835BD, 835AD)	09.89 - 07.99	1.8 i.e. (835AC, 835BC)	09.89 - 06.94	2.0 i.e. (835AL)	09.89 - 07.99	2.0 i.e. (835AI)	09.89 - 07.92	2.0 16V (835ED)	07.94 - 07.99	2.0 i.e. Turbo (835AR)	04.91 - 07.99	2.0 i.e. Turbo Integrale (835AO)	05.90 - 07.94	2.0 HF Integrale (835AP)	11.90 - 07.94	2.0 Turbo (835AQ)	11.90 - 06.94	1.9 TDS (835EE, 835EF)	04.89 - 07.99	1.6 i.e. (835AB)	08.89 - 03.93	1.6 i.e. (835AA)	08.89 - 06.94	07.1990->		
1.6 i.e. (835AN)	04.93 - 07.99																																									
1.6 LE (835EB) KAT	07.94 - 07.99																																									
1.6 16V (835EI)	01.96 - 07.99																																									
1.8 16V LE (835FG)	03.96 - 07.99																																									
1.8 GT 16V (835EH)	03.96 - 07.99																																									
1.8 i.e. (835AT)	08.93 - 07.99																																									
1.8 i.e. (835FA)	07.94 - 07.99																																									
1.8 i.e. (835BD, 835AD)	09.89 - 07.99																																									
1.8 i.e. (835AC, 835BC)	09.89 - 06.94																																									
2.0 i.e. (835AL)	09.89 - 07.99																																									
2.0 i.e. (835AI)	09.89 - 07.92																																									
2.0 16V (835ED)	07.94 - 07.99																																									
2.0 i.e. Turbo (835AR)	04.91 - 07.99																																									
2.0 i.e. Turbo Integrale (835AO)	05.90 - 07.94																																									
2.0 HF Integrale (835AP)	11.90 - 07.94																																									
2.0 Turbo (835AQ)	11.90 - 06.94																																									
1.9 TDS (835EE, 835EF)	04.89 - 07.99																																									
1.6 i.e. (835AB)	08.89 - 03.93																																									
1.6 i.e. (835AA)	08.89 - 06.94																																									
	<b>Lenker, Radaufhängung / Track Control Arm</b>		<b>28867</b>	<b>82 461 081</b>																																						
	Material: Stahl geschmiedet / material: steel forging																																									
	ALL TYPES ausser/except for :																																									
	2.0 16V 4WD	07.94 - 07.99																																								
	<b>Lenker, Radaufhängung / Track Control Arm</b>		<b>28868</b>	<b>82 461 082</b>																																						
	Material: Stahl geschmiedet / material: steel forging																																									
	ALL TYPES ausser/except for :																																									
	2.0 16V 4WD	07.94 - 07.99																																								
	<b>Stange/Strebe, Stabilisator / Rod/Strut, stabiliser</b>		<b>26759</b>																																							
	Pendelstange / Suspension Rod																																									
	ALL TYPES																																									











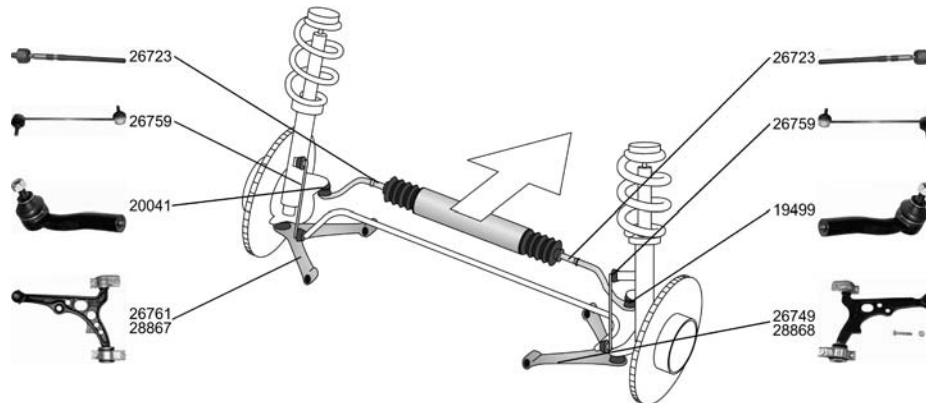





OE

**LANCIA**

**DEDRA SW/Estate/Break (835)**

**07.94 - 07.99**



<p><b>Spurstangenkopf / Tie-rod End</b>                      Gewindeart: mit Rechtsgewinde / Thread Type: with right-hand thread                      Gewindemaß / Thread Size:M12x1,5                      ALL TYPES</p>		<p><b>19499</b>      7 591 215</p> 
<p><b>Spurstangenkopf / Tie-rod End</b>                      Gewindemaß / Thread Size:M12x1,5                      Gewindeart: mit Rechtsgewinde / Thread Type: with right-hand thread                      Innengewinde [mm] / Inner Thread [mm]:M12x1,5                      ALL TYPES</p>		<p><b>20041</b>      7 591 216</p> 
<p><b>Axialgelenk, Spurstange / Axial Rod, tie rod</b>                      Aussengewinde [mm] / Outer Thread [mm]:M14x1,5                      Aussengewinde [mm] / Outer Thread [mm]:M12x1,5                      ALL TYPES</p>		<p><b>26723</b>      9 941 625</p> 
<p><b>Lenker, Radaufhängung / Track Control Arm</b>                      1.8 GT 16V (835EH)      03.96 - 07.99                      2.0 16V (835ED)      07.94 - 07.99                      1.9 TDS (835EE, 835EF)      07.94 - 07.99</p>	 12.1997->	<p><b>26749</b>      46 474 557</p> 
<p><b>Lenker, Radaufhängung / Track Control Arm</b>                      1.8 GT 16V (835EH)      03.96 - 07.99                      2.0 16V (835ED)      07.94 - 07.99                      1.9 TDS (835EE, 835EF)      07.94 - 07.99</p>	 12.1997->	<p><b>26761</b>      46 474 556</p> 
<p><b>Lenker, Radaufhängung / Track Control Arm</b>                      Material: Stahl geschmiedet / material: steel forging                      ALL TYPES</p>		<p><b>28867</b>      82 461 081</p>
<p><b>Lenker, Radaufhängung / Track Control Arm</b>                      Material: Stahl geschmiedet / material: steel forging                      ALL TYPES</p>		<p><b>28868</b>      82 461 082</p>
<p><b>Stange/Strebe, Stabilisator / Rod/Strut, stabiliser</b>                      Pendelstange / Suspension Rod                      ALL TYPES</p>		<p><b>26759</b></p> 









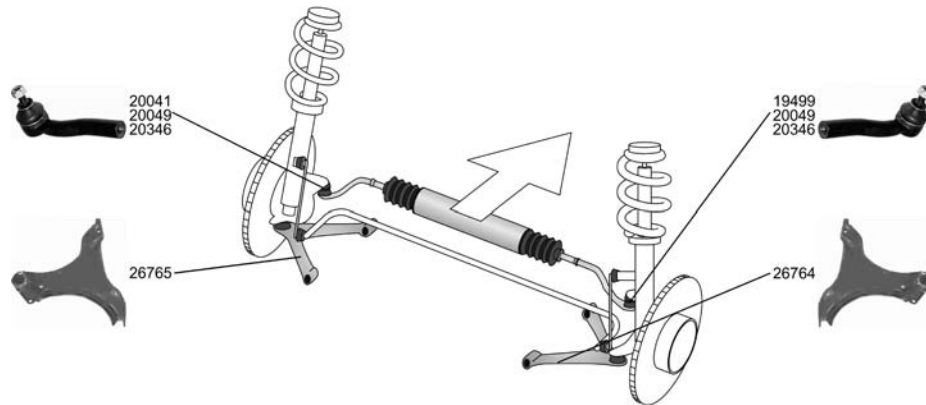





# LANCIA

DELTA I (831AB0)

09.79 - 01.94



<p><b>Spurstangenkopf / Tie-rod End</b>                      Gewindeart: mit Rechtsgewinde / Thread Type: with right-hand thread                      Gewindemaß / Thread Size:M12x1,5</p>		<p><b>19499</b>      7 591 215</p> 
<p>1.9 Turbo DS (831AB.021)      10.86 - 12.89</p>		
<p><b>Spurstangenkopf / Tie-rod End</b>                      Gewindemaß / Thread Size:M12x1,5                      Gewindeart: mit Rechtsgewinde / Thread Type: with right-hand thread                      Innengewinde [mm] / Inner Thread [mm]:M12x1,5</p>		<p><b>20041</b>      7 591 216</p> 
<p>1.9 Turbo DS (831AB.021)      10.86 - 12.89</p>		
<p><b>Spurstangenkopf / Tie-rod End</b>                      Gewindeart: mit Rechtsgewinde / Thread Type: with right-hand thread                      Gewindemaß / Thread Size:M12x1,5</p>		<p><b>20049</b>      82 392 503</p> 
<p>1.6 HF Turbo (831AB.020S)      04.87 - 03.89                      2.0 HF Integrale (831AB.024S, 831AB.028)      12.86 - 12.92                      2.0 HF Integrale (831AB.024)      10.87 - 02.89                      2.0 16V HF Integrale (831AB.026)      03.89 - 09.91                      2.0 16V HF Evo Integrale (831AB.027)      06.93 - 01.94</p>		
<p><b>Spurstangenkopf / Tie-rod End</b>                      Gewindeart: mit Rechtsgewinde / Thread Type: with right-hand thread                      Aussengewinde [mm] / Outer Thread [mm]:M14x1,5                      Konusmaß [mm] / Cone Size [mm]:14                      mit Zubehör / With accessories</p>		<p><b>20346</b>      82 387 676</p> 
<p>2.0 16V HF Evo Integrale (831AB.027)      06.93 - 01.94</p>		
<p><b>Lenker, Radaufhängung / Track Control Arm</b></p>		<p><b>26764</b></p> 
<p>1.3 (831AB.011)      09.79 - 08.92                      1.3      09.83 - 08.92                      1.5 (831AB.025)      09.79 - 12.92</p>	08.1986->	
<p><b>Lenker, Radaufhängung / Track Control Arm</b></p>		<p><b>26765</b>      82 391 820</p> 
<p>1.3 (831AB.011)      09.79 - 08.92                      1.3      09.83 - 08.92                      1.5 (831AB.025)      09.79 - 12.92</p>	08.1986->	
<p><b>Faltenbalgsatz, Lenkung / Bellow Kit, steering system</b>                      Innendurchmesser 1 [mm] / Inner Diameter 1 [mm]:10                      Innendurchmesser 2 [mm] / Inner Diameter 2 [mm]:42</p>		<p><b>30133</b>      4 371 155</p>
<p>1.3 (831AB.011)      09.79 - 08.92</p>	->11.1982 ->Chass. 293 228	
<p>1.3 (831AB.011)      09.79 - 08.92</p>	10.1987->	
<p>1.3 (831AB.011)      09.79 - 08.92</p>	Chass. 293 229->	
<p>1.5 (831AB.025)      09.79 - 12.92</p>	->11.1982 ->Chass. 293 228	
<p>1.6 GT i.e. (831AB.010)      05.87 - 08.92</p>	->Chass. 029 228	
<p>1.6 GT i.e. (831AB.010)      05.87 - 08.92</p>	Chass. 293 229->	





OE

**LANCIA**

**DELTA I (831AB0)**

**09.79 - 01.94**





 <b>Faltenbalgsatz, Lenkung / Bellow Kit, steering system</b> Innendurchmesser 1 [mm] / Inner Diameter 1 [mm]:10 Innendurchmesser 2 [mm] / Inner Diameter 2 [mm]:26		<b>30134</b>	<b>4 371 156</b>		
				1.3 (831AB.011)	09.79 - 08.92
				1.5 (831AB.025)	09.79 - 12.92
				1.6 GT i.e. (831AB.010)	05.87 - 08.92

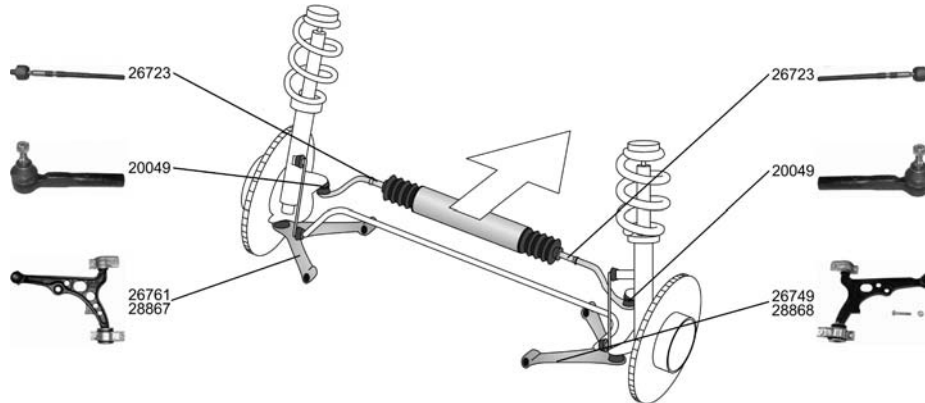

**DELTA II (836)**

**06.93 - 08.99**





<b>Spurstangenkopf / Tie-rod End</b> Gewindeart: mit Rechtsgewinde / Thread Type: with right-hand thread Gewindemaß / Thread Size:M12x1,5 ALL TYPES ausser/except for :		<b>20049</b>	<b>82 392 503</b>		
				1.6 16V (836)	09.93 -
				1.8 16V (836)	09.93 -
<b>Axialgelenk, Spurstange / Axial Rod, tie rod</b> Aussengewinde [mm] / Outer Thread [mm]:M14x1,5 Aussengewinde [mm] / Outer Thread [mm]:M12x1,5		<b>26723</b>	<b>9 941 625</b>		
				1.4 i.e. (836AF, 836AH)	10.94 - 08.99
				1.6 i.e. (836AD)	06.93 - 08.99
				1.6 i.e. (836AP)	03.96 - 08.99
				1.6 i.e. 16V (836AO)	01.96 - 08.99
				1.8 i.e. 16V (836AQ)	03.96 - 08.99
				1.8 i.e. (836AG, 836AL)	07.94 - 08.99
				1.8 i.e. (836AE)	06.93 - 08.99
				2.0 16V (836AA, 836CA)	06.93 - 08.99
				<b>Lenker, Radaufhängung / Track Control Arm</b>	
1.8 i.e. 16V GT (836AR)	03.96 - 08.99				
2.0 16V Turbo (836AB)	06.93 - 08.99				
2.0 16V Turbo (836AS)	07.96 - 08.99				
1.9 TD (836AM, 836AN)	10.94 - 08.99				
<b>Lenker, Radaufhängung / Track Control Arm</b>		<b>26761</b>	<b>46 474 556</b>		
				1.8 i.e. 16V GT (836AR)	03.96 - 08.99
				2.0 16V Turbo (836AB)	06.93 - 08.99
				2.0 16V Turbo (836AS)	07.96 - 08.99
				1.9 TD (836AM, 836AN)	10.94 - 08.99
<b>Lenker, Radaufhängung / Track Control Arm</b> Material: Stahl geschmiedet / material: steel forging		<b>28867</b>	<b>82 461 081</b>		
				1.4 i.e. (836AF, 836AH)	10.94 - 08.99
				1.6 i.e. (836AD)	06.93 - 08.99
				1.6 i.e. (836AP)	03.96 - 08.99
				1.6 i.e. 16V (836AO)	01.96 - 08.99
				1.8 i.e. 16V (836AQ)	03.96 - 08.99
				1.8 i.e. 16V GT (836AR)	03.96 - 08.99
				1.8 i.e. (836AG, 836AL)	07.94 - 08.99
				1.8 i.e. (836AE)	06.93 - 08.99



# LANCIA

## DELTA II (836)







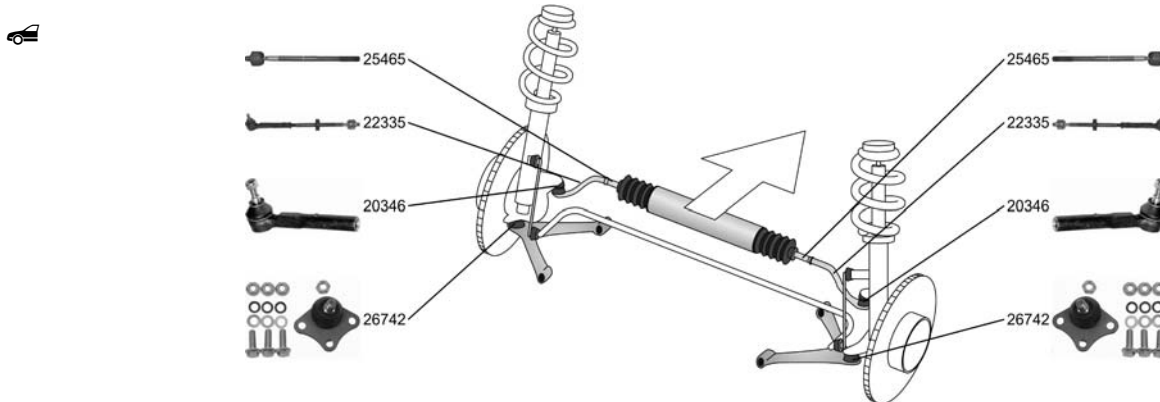

06.93 - 08.99

 <b>Lenker, Radaufhängung / Track Control Arm</b> Material: Stahl geschmiedet / material: steel forging		<b>28868</b>	<b>82 461 082</b>		
				1.4 i.e. (836AF, 836AH)	10.94 - 08.99
				1.6 i.e. (836AD)	06.93 - 08.99
				1.6 i.e. (836AP)	03.96 - 08.99
				1.6 i.e. 16V (836AO)	01.96 - 08.99
				1.8 i.e. 16V (836AQ)	03.96 - 08.99
				1.8 i.e. 16V GT (836AR)	03.96 - 08.99
				1.8 i.e. (836AG, 836AL)	07.94 - 08.99
1.8 i.e. (836AE)	06.93 - 08.99				

## KAPPA (838A)

08.94 - 10.01



<b>Spurstange / Tie Rod, steering</b> ALL TYPES		<b>22335</b>	<b>9 945 565</b>
			
<b>Spurstangenkopf / Tie-rod End</b> Gewindeart: mit Rechtsgewinde / Thread Type: with right-hand thread Aussengewinde [mm] / Outer Thread [mm]: M14x1,5 Konusmaß [mm] / Cone Size [mm]: 14 mit Zubehör / With accessories ALL TYPES ausser/except for : 2.0 20V Turbo (838AM1AA) 06.98 - 10.01 2.4 JTD (838AL1AA) 06.98 - 10.01		<b>20346</b>	<b>82 387 676</b>
			
<b>Axialgelenk, Spurstange / Axial Rod, tie rod</b> ALL TYPES		<b>25465</b>	<b>9 946 815</b>
			
<b>Trag-/Führungsgelenk / Support-/ Steering Link</b> ALL TYPES		<b>26742</b>	<b>82 480 099</b>
			









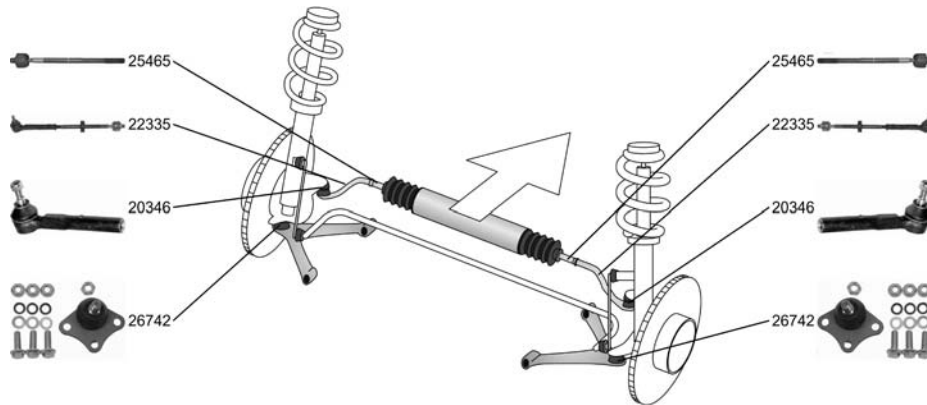

OE

# LANCIA

## KAPPA Coupe (838)

07.96 - 03.01





<p><b>Spurstange / Tie Rod, steering</b></p> <p>ALL TYPES ausser/except for : 2.4 TD (838) 11.96 -</p>		<p><b>22335</b> 9 945 565</p> 
<p><b>Spurstangenkopf / Tie-rod End</b></p> <p>Gewindeart: mit Rechtsgewinde / Thread Type: with right-hand thread Aussengewinde [mm] / Outer Thread [mm]:M14x1,5 Konusmaß [mm] / Cone Size [mm]:14 mit Zubehör / With accessories</p> <p>2.0 16V Turbo (838CB) 11.96 - 03.01 2.0 20V 07.96 - 03.01 2.4 20V (838CC) 11.96 - 03.01 3.0 24V (838CD, 838CD11A) 11.96 - 03.01</p>		<p><b>20346</b> 82 387 676</p> 
<p><b>Axialgelenk, Spurstange / Axial Rod, tie rod</b></p> <p>ALL TYPES ausser/except for : 2.4 TD (838) 11.96 -</p>		<p><b>25465</b> 9 946 815</p> 
<p><b>Trag-/Führungsgelenk / Support-/ Steering Link</b></p> <p>ALL TYPES ausser/except for : 2.4 TD (838) 11.96 -</p>		<p><b>26742</b> 82 480 099</p> 

## KAPPA SW/Estate/Break (838B)

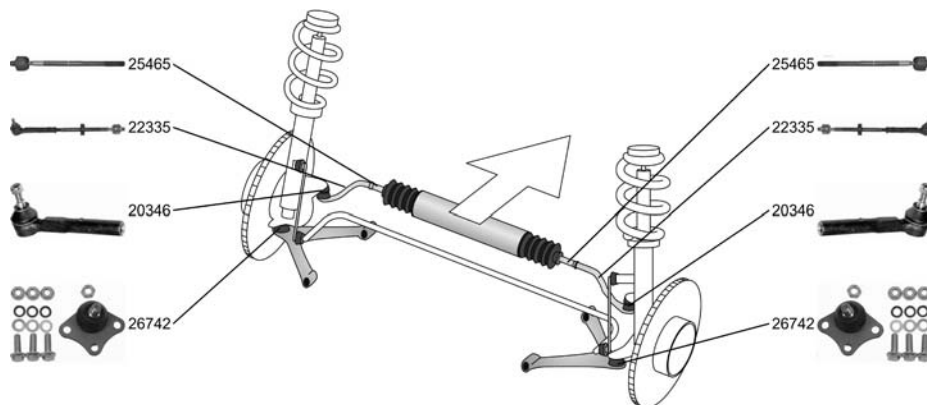
07.96 - 10.01







<p><b>Spurstange / Tie Rod, steering</b></p> <p>ALL TYPES</p>		<p><b>22335</b> 9 945 565</p> 
---------------------------------------------------------------	-------------------------------------------------------------------------------------	---------------------------------------------------------------------------------------------------------------------



# LANCIA

## KAPPA SW/Estate/Break (838B)





07.96 - 10.01

 <b>Spurstangenkopf / Tie-rod End</b> Gewindeart: mit Rechtsgewinde / Thread Type: with right-hand thread Aussengewinde [mm] / Outer Thread [mm]:M14x1,5 Konusmaß [mm] / Cone Size [mm]:14 mit Zubehör / With accessories		<b>20346</b> 82 387 676 
ALL TYPES ausser/except for : 2.0 20V Turbo (838BM1AA)      06.98 - 10.01 2.4 JTD (838BL1AA)      06.98 - 10.01		
<b>Axialgelenk, Spurstange / Axial Rod, tie rod</b>		<b>25465</b> 9 946 815 
ALL TYPES		
<b>Trag-/Führungsgelenk / Support-/ Steering Link</b>		<b>26742</b> 82 480 099 
ALL TYPES		

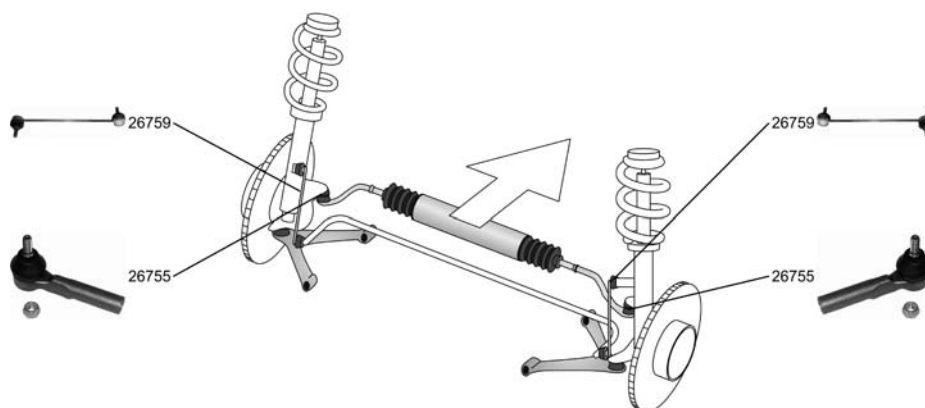
## LYBRA (839AX)

07.99 -



<b>Spurstangenkopf / Tie-rod End</b>		<b>26755</b> 9 947 926 
ALL TYPES		
<b>Stange/Strebe, Stabilisator / Rod/Strut, stabiliser</b>		<b>26759</b> 
Pendelstange / Suspension Rod ALL TYPES		
<b>Faltenbalgsatz, Lenkung / Bellow Kit, steering system</b>		<b>30227</b> 
ALL TYPES ausser/except for : 2.4 JTD (839AXE1A)      07.99 - 09.00 2.4 JTD (839AXL1A)      09.00 - 05.02 2.4 JTD      05.02 -		
 <b>Stange/Strebe, Stabilisator / Rod/Strut, stabiliser</b>		<b>26819</b> 46 545 749 
Pendelstange / Suspension Rod ohne Zubehör / without accessories ALL TYPES		









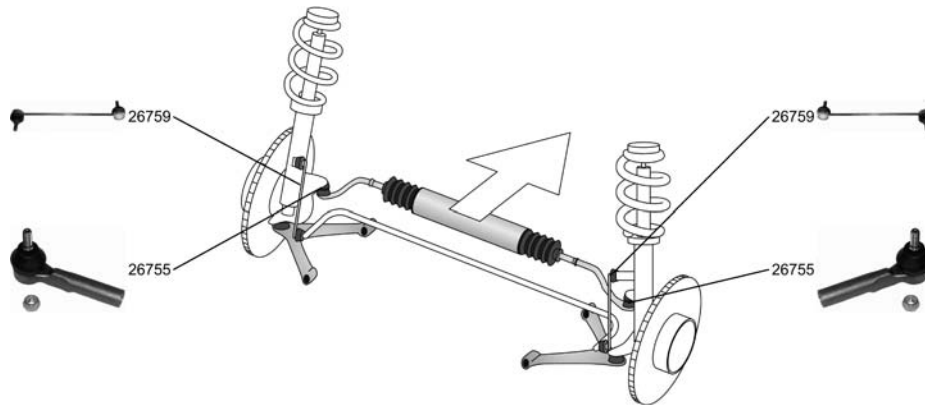

OE

**LANCIA**

**LYBRA SW/Estate/Break (839BX)**

**07.99 -**



<b>Spurstangenkopf / Tie-rod End</b> ALL TYPES	↔	<b>26755</b> 9 947 926
ALL TYPES		
<b>Stange/Strebe, Stabilisator / Rod/Strut, stabiliser</b> Pendelstange / Suspension Rod ALL TYPES	↔	<b>26759</b> 
<b>Faltenbalgatz, Lenkung / Bellow Kit, steering system</b> ALL TYPES ausser/except for : 2.4 JTD (839BXE1A)      10.99 - 09.00 2.4 JTD (839BXL1A)      09.00 - 2.4 JTD      05.02 -	↔	<b>30227</b> 
 <b>Stange/Strebe, Stabilisator / Rod/Strut, stabiliser</b> Pendelstange / Suspension Rod ohne Zubehör / without accessories ALL TYPES	↔	<b>26819</b> 46 545 749 

**PHEDRA (179)**

**09.02 -**

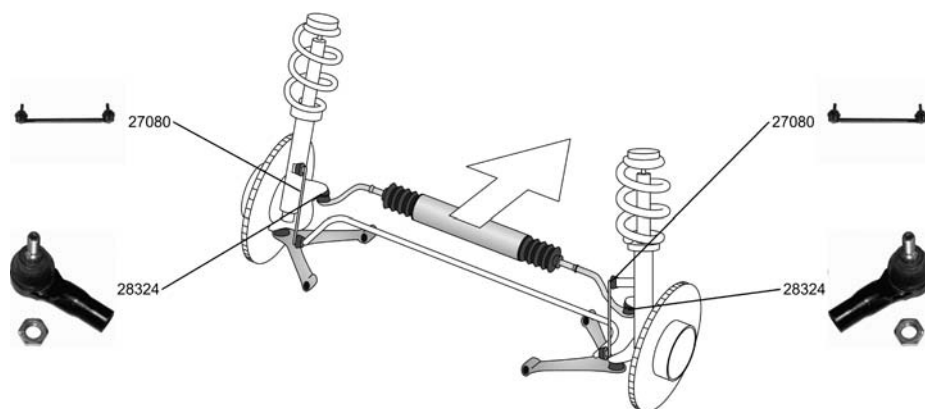



<b>Spurstangenkopf / Tie-rod End</b> Konusmaß [mm] / Cone Size [mm]:15,45 ohne Anbaumaterial / without add-on material	↔	<b>28324</b> 77 362 279
ALL TYPES ausser/except for : 2.0 JTD, 88 kW      06.06 -		



# LANCIA



## PHEDRA (179)

09.02 -

 <b>Stange/Strebe, Stabilisator / Rod/Strut, stabiliser</b> Pendelstange / Suspension Rod ohne Zubehör / without accessories ALL TYPES ausser/except for : 2.0 JTD, 88 kW		<b>27080</b>	<b>13312 09080</b>
			
06.06 -			

## PRISMA (831AB0)

01.83 - 02.92







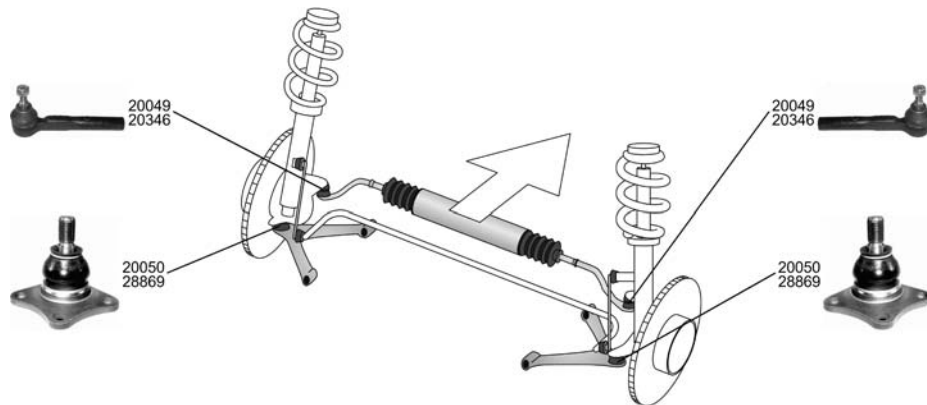

 <b>Faltenbaldsatz, Lenkung / Bellow Kit, steering system</b> Innendurchmesser 1 [mm] / Inner Diameter 1 [mm]:10 Innendurchmesser 2 [mm] / Inner Diameter 2 [mm]:42 1.5, 63 kW 1.6, 77 kW 1.9 Turbo Diesel		<b>30133</b>	<b>4 371 155</b>		
				01.83 - 04.86	
				12.82 - 04.86	
<b>Faltenbaldsatz, Lenkung / Bellow Kit, steering system</b> Innendurchmesser 1 [mm] / Inner Diameter 1 [mm]:10 Innendurchmesser 2 [mm] / Inner Diameter 2 [mm]:26 1.5, 63 kW 1.6, 77 kW 1.9 Turbo Diesel		<b>30134</b>	<b>4 371 156</b>		
				01.83 - 04.86	
				12.82 - 04.86	
05.85 - 12.89					



## THEMA (834)

11.84 - 07.94



<b>Spurstangenkopf / Tie-rod End</b> Gewindeart: mit Rechtsgewinde / Thread Type: with right-hand thread Gewindemaß / Thread Size:M12x1,5 ALL TYPES ausser/except for : 2000 i.e (834AB) 09.88 - 05.92 2000 i.e. 16V (834AA) 05.88 - 08.92 2850 V6 i.e. (834AD, 834CD, 834BD) 06.88 - 05.92		<b>20049</b>	<b>82 392 503</b>
			
<b>Spurstangenkopf / Tie-rod End</b> Gewindeart: mit Rechtsgewinde / Thread Type: with right-hand thread Aussengewinde [mm] / Outer Thread [mm]:M14x1,5 Konusmaß [mm] / Cone Size [mm]:14 mit Zubehör / With accessories ALL TYPES		<b>20346</b>	<b>82 387 676</b>
			
<b>Trag-/Führungsgelenk / Support-/ Steering Link</b> ohne Zubehör / without accessories ALL TYPES ausser/except for : 2000 i.e (834AB) 09.88 - 05.92 2000 i.e. 16V (834AA) 05.88 - 08.92		<b>20050</b>	
			
<b>Trag-/Führungsgelenk / Support-/ Steering Link</b> Konusmaß [mm] / Cone Size [mm]:13 ALL TYPES ausser/except for : 2000 i.e (834AB) 09.88 - 05.92 2000 i.e. 16V (834AA) 05.88 - 08.92		<b>28869</b>	
			







OE

**LANCIA**

**THEMA (834)**





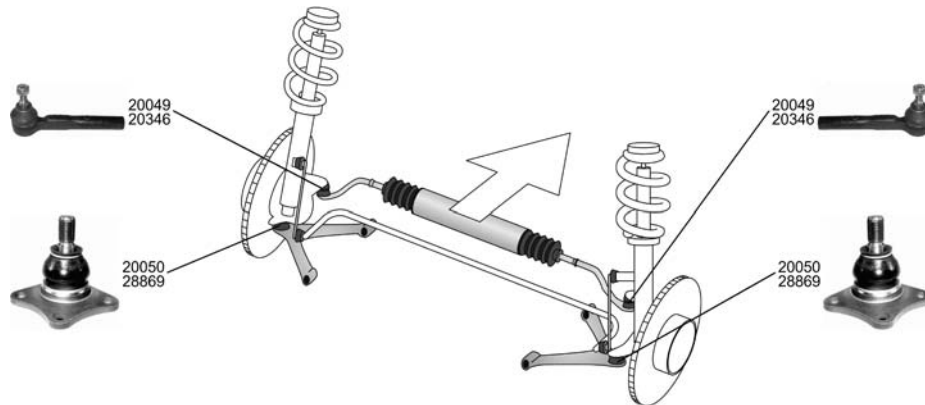

**11.84 - 07.94**

<p> <b>Faltenbalgsatz, Lenkung / Bellow Kit, steering system</b></p> <table border="0"> <tr><td>2000 i.e.</td><td>03.86 - 09.88</td></tr> <tr><td>2000 i.e. (834BV)</td><td>09.87 - 05.92</td></tr> <tr><td>2000 i.e. (834B)</td><td>11.84 - 09.88</td></tr> <tr><td>2000 i.e. 16V (834AI)</td><td>02.89 - 05.92</td></tr> <tr><td>2000 i.e. Turbo (834CV)</td><td>07.86 - 05.90</td></tr> <tr><td>2000 16V (834FA)</td><td>08.92 - 12.93</td></tr> <tr><td>2000 i.e. Turbo (834C)</td><td>11.84 - 12.87</td></tr> <tr><td>2000 i.e. 16V Turbo (834AL)</td><td>04.89 - 05.92</td></tr> <tr><td>2850 V6 i.e. (834AD, 834CD, 834BD)</td><td>06.88 - 05.92</td></tr> <tr><td>2850 V6 i.e. (834F)</td><td>11.84 - 09.88</td></tr> <tr><td>3000 V6 (834GD, 834FD)</td><td>08.92 - 07.94</td></tr> <tr><td>2500 Turbo D (834D)</td><td>11.84 - 09.88</td></tr> <tr><td>2500 Turbo DS (834AE)</td><td>06.88 - 05.92</td></tr> <tr><td>2500 Turbo DS (834AM)</td><td>05.88 - 07.92</td></tr> </table>	2000 i.e.	03.86 - 09.88	2000 i.e. (834BV)	09.87 - 05.92	2000 i.e. (834B)	11.84 - 09.88	2000 i.e. 16V (834AI)	02.89 - 05.92	2000 i.e. Turbo (834CV)	07.86 - 05.90	2000 16V (834FA)	08.92 - 12.93	2000 i.e. Turbo (834C)	11.84 - 12.87	2000 i.e. 16V Turbo (834AL)	04.89 - 05.92	2850 V6 i.e. (834AD, 834CD, 834BD)	06.88 - 05.92	2850 V6 i.e. (834F)	11.84 - 09.88	3000 V6 (834GD, 834FD)	08.92 - 07.94	2500 Turbo D (834D)	11.84 - 09.88	2500 Turbo DS (834AE)	06.88 - 05.92	2500 Turbo DS (834AM)	05.88 - 07.92	<p></p>	<p><b>30135</b></p> 
2000 i.e.	03.86 - 09.88																													
2000 i.e. (834BV)	09.87 - 05.92																													
2000 i.e. (834B)	11.84 - 09.88																													
2000 i.e. 16V (834AI)	02.89 - 05.92																													
2000 i.e. Turbo (834CV)	07.86 - 05.90																													
2000 16V (834FA)	08.92 - 12.93																													
2000 i.e. Turbo (834C)	11.84 - 12.87																													
2000 i.e. 16V Turbo (834AL)	04.89 - 05.92																													
2850 V6 i.e. (834AD, 834CD, 834BD)	06.88 - 05.92																													
2850 V6 i.e. (834F)	11.84 - 09.88																													
3000 V6 (834GD, 834FD)	08.92 - 07.94																													
2500 Turbo D (834D)	11.84 - 09.88																													
2500 Turbo DS (834AE)	06.88 - 05.92																													
2500 Turbo DS (834AM)	05.88 - 07.92																													
<p><b>Faltenbalgsatz, Lenkung / Bellow Kit, steering system</b>                  Innendurchmesser 1 [mm] / Inner Diameter 1 [mm]:10                  Innendurchmesser 2 [mm] / Inner Diameter 2 [mm]:44</p>	<p></p>	<p><b>30184</b>      <b>9 938 779-R</b></p> 																												
<p>ALL TYPES ausser/except for :</p> <table border="0"> <tr><td>2000 i.e (834AB)</td><td>09.88 - 05.92</td></tr> <tr><td>2000 i.e. 16V (834AA)</td><td>05.88 - 08.92</td></tr> </table>	2000 i.e (834AB)	09.88 - 05.92	2000 i.e. 16V (834AA)	05.88 - 08.92																										
2000 i.e (834AB)	09.88 - 05.92																													
2000 i.e. 16V (834AA)	05.88 - 08.92																													

**THEMA SW/Estate/Break (834)**

**03.87 - 07.94**





<p><b>Spurstangenkopf / Tie-rod End</b>                  Gewindeart: mit Rechtsgewinde / Thread Type: with right-hand thread                  Gewindemaß / Thread Size:M12x1,5</p> <table border="0"> <tr><td>2000 i.e. 16V (834AI)</td><td>02.89 - 05.92</td></tr> <tr><td>2000 Turbo</td><td>01.89 - 03.92</td></tr> <tr><td>2000 16V (834FA)</td><td>05.92 - 07.94</td></tr> <tr><td>2000 i.e. 16V Turbo (834AL)</td><td>04.89 - 03.93</td></tr> <tr><td>2000 Turbo 16V (834GC, 834FC)</td><td>11.92 - 07.94</td></tr> <tr><td>3000 V6 (834GD, 834FD)</td><td>09.92 - 07.94</td></tr> <tr><td>2500 Turbo DS (834D)</td><td>03.87 - 09.90</td></tr> <tr><td>2500 Turbo DS (834FE, 834LE)</td><td>09.92 - 04.97</td></tr> </table>	2000 i.e. 16V (834AI)	02.89 - 05.92	2000 Turbo	01.89 - 03.92	2000 16V (834FA)	05.92 - 07.94	2000 i.e. 16V Turbo (834AL)	04.89 - 03.93	2000 Turbo 16V (834GC, 834FC)	11.92 - 07.94	3000 V6 (834GD, 834FD)	09.92 - 07.94	2500 Turbo DS (834D)	03.87 - 09.90	2500 Turbo DS (834FE, 834LE)	09.92 - 04.97	<p></p>	<p><b>20049</b>      <b>82 392 503</b></p> 
2000 i.e. 16V (834AI)	02.89 - 05.92																	
2000 Turbo	01.89 - 03.92																	
2000 16V (834FA)	05.92 - 07.94																	
2000 i.e. 16V Turbo (834AL)	04.89 - 03.93																	
2000 Turbo 16V (834GC, 834FC)	11.92 - 07.94																	
3000 V6 (834GD, 834FD)	09.92 - 07.94																	
2500 Turbo DS (834D)	03.87 - 09.90																	
2500 Turbo DS (834FE, 834LE)	09.92 - 04.97																	
<p><b>Spurstangenkopf / Tie-rod End</b>                  Gewindeart: mit Rechtsgewinde / Thread Type: with right-hand thread                  Aussengewinde [mm] / Outer Thread [mm]:M14x1,5                  Konusmaß [mm] / Cone Size [mm]:14                  mit Zubehör / With accessories</p> <p>ALL TYPES</p>	<p></p>	<p><b>20346</b>      <b>82 387 676</b></p> 																
<p><b>Trag-/Führungsgelenk / Support-/ Steering Link</b>                  ohne Zubehör / without accessories</p> <p>ALL TYPES</p>	<p></p>	<p><b>20050</b></p> 																
<p><b>Trag-/Führungsgelenk / Support-/ Steering Link</b>                  Konusmaß [mm] / Cone Size [mm]:13</p> <p>ALL TYPES</p>	<p></p>	<p><b>28869</b></p>																



# LANCIA

**THEMA SW/Estate/Break (834)**





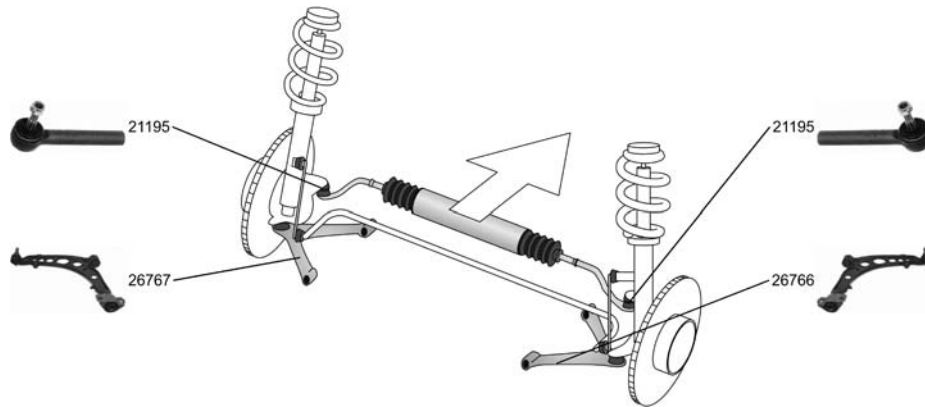

**03.87 - 07.94**

 <b>Faltenbalgsatz, Lenkung / Bellow Kit, steering system</b> Innendurchmesser 1 [mm] / Inner Diameter 1 [mm]:10 Innendurchmesser 2 [mm] / Inner Diameter 2 [mm]:44		<b>30184</b> <b>9 938 779-R</b> 

**Y (840A)**

**11.95 -**



<b>Spurstangenkopf / Tie-rod End</b> Gewindeart: mit Rechtsgewinde / Thread Type: with right-hand thread ALL TYPES		<b>21195</b> <b>9 946 949</b> 
<b>Lenker, Radaufhängung / Track Control Arm</b> ALL TYPES		<b>26766</b> <b>46 430 003</b> 
<b>Lenker, Radaufhängung / Track Control Arm</b> ALL TYPES		<b>26767</b> <b>46 430 002</b> 









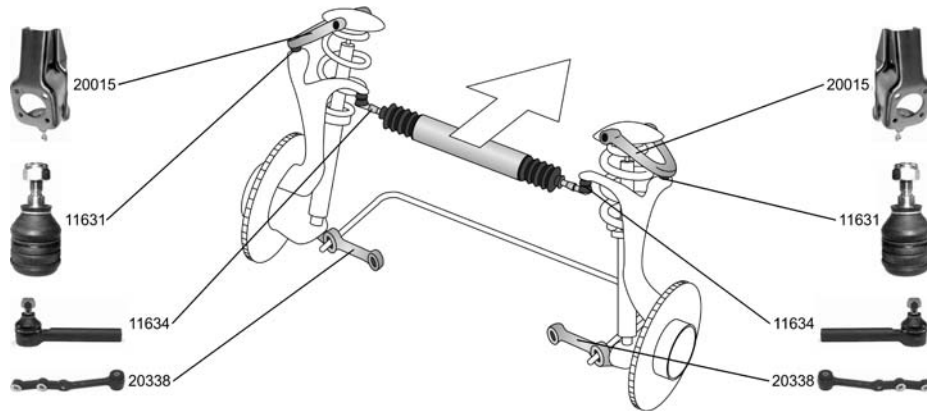

OE

**LANCIA**

**Y10 (156)**

**03.85 - 12.95**



<p><b>Spurstangenkopf / Tie-rod End</b>                      Gewindeart: mit Rechtsgewinde / Thread Type: with right-hand thread                      Gewindemaß / Thread Size:M10x1</p> <p>ALL TYPES ausser/except for :</p> <table border="1"> <tr> <td>1.0 Touring</td> <td>03.85 - 12.89</td> </tr> <tr> <td>1.0 Fire</td> <td>03.90 - 12.97</td> </tr> <tr> <td>1.0 Turbo</td> <td>03.89 - 12.93</td> </tr> </table>	1.0 Touring	03.85 - 12.89	1.0 Fire	03.90 - 12.97	1.0 Turbo	03.89 - 12.93		<p><b>11634</b>      5 983 406</p> 																
1.0 Touring	03.85 - 12.89																							
1.0 Fire	03.90 - 12.97																							
1.0 Turbo	03.89 - 12.93																							
<p><b>Lenker, Radaufhängung / Track Control Arm</b></p> <table border="1"> <tr> <td>1.0 Fire (156B, 156AD)</td> <td>06.85 - 06.91</td> </tr> <tr> <td>1.0 Fire 4WD</td> <td>12.86 - 02.90</td> </tr> <tr> <td>1.0 Fire (156AE) KAT</td> <td>10.87 - 02.92</td> </tr> <tr> <td>1.0 Fire 4WD (156AE)</td> <td>12.87 - 02.92</td> </tr> <tr> <td>1.0 Fire</td> <td>03.85 - 02.90</td> </tr> <tr> <td>1.0 Fire (156C)</td> <td>03.85 - 07.89</td> </tr> <tr> <td>1.0 Turbo (156D)</td> <td>03.85 - 02.89</td> </tr> <tr> <td>1.1 i.e. Fire (156AG)</td> <td>07.89 - 09.95</td> </tr> <tr> <td>1.1 Avenue (156AG)</td> <td>01.95 - 12.95</td> </tr> <tr> <td>1.3 i.e. Fire (156AF)</td> <td>02.89 - 12.95</td> </tr> <tr> <td>1.3 i.e. Fire (156AB)</td> <td>11.87 - 05.93</td> </tr> </table>	1.0 Fire (156B, 156AD)	06.85 - 06.91	1.0 Fire 4WD	12.86 - 02.90	1.0 Fire (156AE) KAT	10.87 - 02.92	1.0 Fire 4WD (156AE)	12.87 - 02.92	1.0 Fire	03.85 - 02.90	1.0 Fire (156C)	03.85 - 07.89	1.0 Turbo (156D)	03.85 - 02.89	1.1 i.e. Fire (156AG)	07.89 - 09.95	1.1 Avenue (156AG)	01.95 - 12.95	1.3 i.e. Fire (156AF)	02.89 - 12.95	1.3 i.e. Fire (156AB)	11.87 - 05.93		<p><b>20015</b></p> 
1.0 Fire (156B, 156AD)	06.85 - 06.91																							
1.0 Fire 4WD	12.86 - 02.90																							
1.0 Fire (156AE) KAT	10.87 - 02.92																							
1.0 Fire 4WD (156AE)	12.87 - 02.92																							
1.0 Fire	03.85 - 02.90																							
1.0 Fire (156C)	03.85 - 07.89																							
1.0 Turbo (156D)	03.85 - 02.89																							
1.1 i.e. Fire (156AG)	07.89 - 09.95																							
1.1 Avenue (156AG)	01.95 - 12.95																							
1.3 i.e. Fire (156AF)	02.89 - 12.95																							
1.3 i.e. Fire (156AB)	11.87 - 05.93																							
<p><b>Lenker, Radaufhängung / Track Control Arm</b></p> <p>ALL TYPES ausser/except for :</p> <table border="1"> <tr> <td>1.0 Touring</td> <td>03.85 - 12.89</td> </tr> <tr> <td>1.0 Fire</td> <td>03.90 - 12.97</td> </tr> <tr> <td>1.0 Turbo</td> <td>03.89 - 12.93</td> </tr> </table>	1.0 Touring	03.85 - 12.89	1.0 Fire	03.90 - 12.97	1.0 Turbo	03.89 - 12.93		<p><b>20338</b>      7 601 261</p> 																
1.0 Touring	03.85 - 12.89																							
1.0 Fire	03.90 - 12.97																							
1.0 Turbo	03.89 - 12.93																							
<p><b>Trag-/Führungsgelenk / Support-/ Steering Link</b></p> <p>ALL TYPES ausser/except for :</p> <table border="1"> <tr> <td>1.0 Touring</td> <td>03.85 - 12.89</td> </tr> <tr> <td>1.0 Fire</td> <td>03.90 - 12.97</td> </tr> <tr> <td>1.0 Turbo</td> <td>03.89 - 12.93</td> </tr> </table>	1.0 Touring	03.85 - 12.89	1.0 Fire	03.90 - 12.97	1.0 Turbo	03.89 - 12.93		<p><b>11631</b>      4 402 649</p> 																
1.0 Touring	03.85 - 12.89																							
1.0 Fire	03.90 - 12.97																							
1.0 Turbo	03.89 - 12.93																							









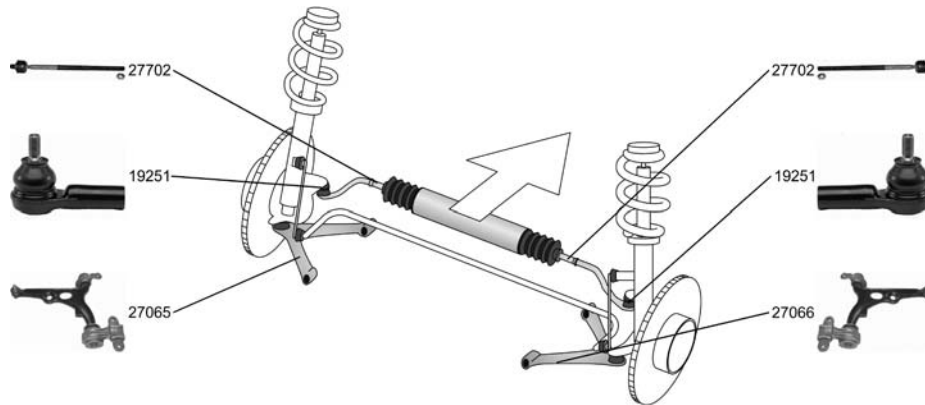



# LANCIA

ZETA (220)



05.95 - 09.02



<p><b>Spurstangenkopf / Tie-rod End</b>                      Gewindeart: mit Rechtsgewinde / Thread Type: with right-hand thread                      Innengewinde [mm] / Inner Thread [mm]:M14x1,5                      mit Zubehör / With accessories                      ALL TYPES</p>		<p><b>19251</b>      13 06 003 080</p> 
<p><b>Axialgelenk, Spurstange / Axial Rod, tie rod</b>                      Aussengewinde [mm] / Outer Thread [mm]:M14x1,5                      ALL TYPES</p>		<p><b>27702</b>      95 66 950 880</p> 
<p><b>Lenker, Radaufhängung / Track Control Arm</b>                      mit Trag-/Führungsgelenk / With support/ steering link                      mit Gummilager / with rubber mounting                      mit Befestigungsmaterial / with fastening material                      ALL TYPES</p>		<p><b>27065</b>      13 33 754 080</p> 
<p><b>Lenker, Radaufhängung / Track Control Arm</b>                      mit Trag-/Führungsgelenk / With support/ steering link                      mit Gummilager / with rubber mounting                      mit Befestigungsmaterial / with fastening material                      ALL TYPES</p>		<p><b>27066</b>      13 33 755 080</p> 
<p><b>Achskörperlager / Mounting, axle body</b>                      ALL TYPES</p>		<p><b>26578</b>      1 479 759 080</p> 

Artikelnummer Article No.	Seite Page	Hersteller Manufacturer	Artikelnummer Article No.	Seite Page	Hersteller Manufacturer
11631	13	LANCIA	26746	2	LANCIA
Trag-/Führungsgelenk / Support-/ Steering Link			Lenker, Radaufhängung / Track Control Arm		
11634	13	LANCIA	26749	3 5	LANCIA
Spurstangenkopf / Tie-rod End			Lenker, Radaufhängung / Track Control Arm		
19251	14	LANCIA	26755	8 9	LANCIA
Spurstangenkopf / Tie-rod End			Spurstangenkopf / Tie-rod End		
19499	1 3 4	LANCIA	26759	2 3 8 9	LANCIA
Spurstangenkopf / Tie-rod End			Stange/Strebe, Stabilisator / Rod/Strut, stabiliser		
20015	13	LANCIA	26761	3 5	LANCIA
Lenker, Radaufhängung / Track Control Arm			Lenker, Radaufhängung / Track Control Arm		
20041	1 3 4	LANCIA	26764	4	LANCIA
Spurstangenkopf / Tie-rod End			Lenker, Radaufhängung / Track Control Arm		
20049	4 5 10 11	LANCIA	26765	4	LANCIA
Spurstangenkopf / Tie-rod End			Lenker, Radaufhängung / Track Control Arm		
20050	10 11	LANCIA	26766	12	LANCIA
Trag-/Führungsgelenk / Support-/ Steering Link			Lenker, Radaufhängung / Track Control Arm		
20338	13	LANCIA	26767	12	LANCIA
Lenker, Radaufhängung / Track Control Arm			Lenker, Radaufhängung / Track Control Arm		
20346	4 6 7 8 10 11	LANCIA	26767	12	LANCIA
Spurstangenkopf / Tie-rod End			Lenker, Radaufhängung / Track Control Arm		
21195	12	LANCIA	26819	8 9	LANCIA
Spurstangenkopf / Tie-rod End			Stange/Strebe, Stabilisator / Rod/Strut, stabiliser		
22335	6 7	LANCIA	27065	14	LANCIA
Spurstange / Tie Rod, steering			Lenker, Radaufhängung / Track Control Arm		
25465	6 7 8	LANCIA	27066	14	LANCIA
Axialgelenk, Spurstange / Axial Rod, tie rod			Lenker, Radaufhängung / Track Control Arm		
26578	14	LANCIA	27080	10	LANCIA
Achskörperlager / Mounting, axle body			Stange/Strebe, Stabilisator / Rod/Strut, stabiliser		
26723	1 3 5	LANCIA	27702	14	LANCIA
Axialgelenk, Spurstange / Axial Rod, tie rod			Axialgelenk, Spurstange / Axial Rod, tie rod		
26742	6 7 8	LANCIA	28324	9	LANCIA
Trag-/Führungsgelenk / Support-/ Steering Link			Spurstangenkopf / Tie-rod End		
26743	1	LANCIA	28867	2 3 5	LANCIA
Lenker, Radaufhängung / Track Control Arm			Lenker, Radaufhängung / Track Control Arm		
26744	1	LANCIA	28868	2 3 6	LANCIA
Lenker, Radaufhängung / Track Control Arm			Lenker, Radaufhängung / Track Control Arm		
26745	2	LANCIA			
Lenker, Radaufhängung / Track Control Arm					

**Arithmetische Liste / Part number list**

<b>Artikelnummer Article No.</b>	<b>Seite Page</b>	<b>Hersteller Manufacturer</b>	<b>Artikelnummer Article No.</b>	<b>Seite Page</b>	<b>Hersteller Manufacturer</b>
28869 	10 11	LANCIA			
Trag-/Führungsgelenk / Support-/ Steering Link					
30133 	4 10	LANCIA			
Faltenbalgsatz, Lenkung / Bellow Kit, steering system					
30134 	5 10	LANCIA			
Faltenbalgsatz, Lenkung / Bellow Kit, steering system					
30135 	11	LANCIA			
Faltenbalgsatz, Lenkung / Bellow Kit, steering system					
30184  	11 12	LANCIA			
Faltenbalgsatz, Lenkung / Bellow Kit, steering system					
30227 	8 9	LANCIA			
Faltenbalgsatz, Lenkung / Bellow Kit, steering system					



Vergleichsliste / Cross reference list

Vergleichs-Nr. Compare No.	Artikelnummer Article No.	Vergleichs-Nr. Compare No.	Artikelnummer Article No.	Vergleichs-Nr. Compare No.	Artikelnummer Article No.
<b>LANCIA</b>					
	1 479 759 080		26578		
	13 06 003 080		19251		
	13 33 754 080		27065		
	13 33 755 080		27066		
	13312 09080		27080		
	4 371 155		30133		
	4 371 156		30134		
	4 402 649		11631		
	46 430 002		26767		
	46 430 003		26766		
	46 474 556		26761		
	46 474 557		26749		
	46 545 749		26819		
	5 983 406		11634		
	7 591 215		19499		
	7 591 216		20041		
	7 601 261		20338		
	76 010 372		26744		
	76 010 373		26743		
	77 362 279		28324		
	82 387 676		20346		
	82 391 820		26765		
	82 392 503		20049		
	82 461 081		28867		
	82 461 082		28868		
	82 480 099		26742		
	9 938 779-R		30184		
	9 941 625		26723		
	9 945 565		22335		
	9 946 815		25465		
	9 946 949		21195		
	9 947 926		26755		
	95 66 950 880		27702		

Neuaufnahmen / New to range

Artikelnummer Article No.	Seite Page	Hersteller Manufacturer	Artikelnummer Article No.	Seite Page	Hersteller Manufacturer
20041	1 3 4	LANCIA	27702	14	LANCIA
20338	13	LANCIA	28324	9	LANCIA
21195	12	LANCIA	28867	2 3 5	LANCIA
26578	14	LANCIA	28868	2 3 6	LANCIA
26723	1 3 5	LANCIA	28869	10 11	LANCIA
26742	6 7 8	LANCIA	30133	4 10	LANCIA
26743	1	LANCIA	30134	5 10	LANCIA
26744	1	LANCIA	30135	11	LANCIA
26745	2	LANCIA	30184	11 12	LANCIA
26746	2	LANCIA	30227	8 9	LANCIA
26749	3 5	LANCIA			
26755	8 9	LANCIA			
26759	2 3 8	LANCIA			
	9				
26761	3 5	LANCIA			
26764	4	LANCIA			
26765	4	LANCIA			
26766	12	LANCIA			
26767	12	LANCIA			
26819	8 9	LANCIA			
27065	14	LANCIA			
27066	14	LANCIA			
27080	10	LANCIA			

**Geänderte Bestellnummer / Amended part numbers**

Artikelnummer alt Article No. old	Artikelnummer neu Article No. new	Artikelnummer alt Article No. old	Artikelnummer neu Article No. new	Artikelnummer alt Article No. old	Artikelnummer neu Article No. new
025 160 102 622	22335				
15355	30133				
15356	30134				
15376	30135				
25220	30184				
26745	28868				
26746	28867				
27913	20346				

**Geänderte Bestellnummer / Amended part numbers**

Artikelnummer neu Article No. new	Artikelnummer alt Article No. old	Artikelnummer neu Article No. new	Artikelnummer alt Article No. old	Artikelnummer neu Article No. new	Artikelnummer alt Article No. old
20346	27913				
22335	025 160 102 622				
28867	26746				
28868	26745				
30133	15355				
30134	15356				
30135	15376				
30184	25220				