













OE

KIA

CERATO 07.04 -





	Spurstangenkopf / Tie-rod End		30354
	2.0 2.0 CRDi	04.04 - 04.04 -	
	Trag-/Führungsgelenk / Support-/ Steering Link		15446 54530-31600
	1.6 2.0 2.0 CRDi	07.04 - 04.04 - 04.04 -	
	Trag-/Führungsgelenk / Support-/ Steering Link		29666 54530-31600
	1.6 2.0 2.0 CRDi	07.04 - 04.04 - 04.04 -	

CERATO Stufenheck 04.04 -

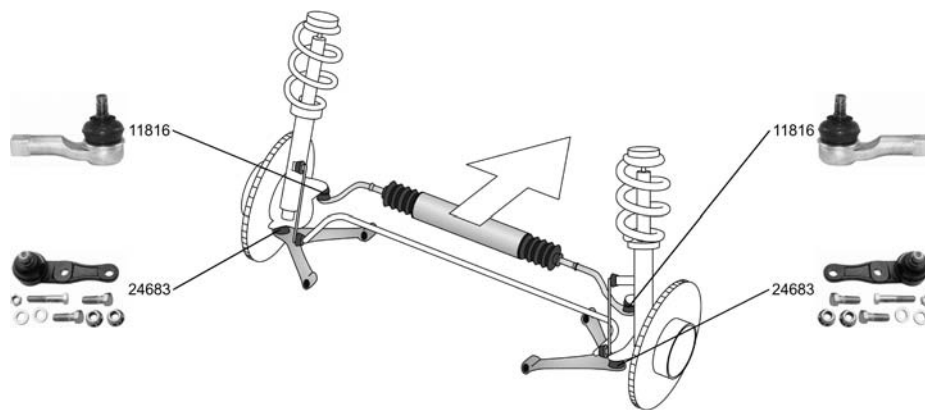
	Spurstangenkopf / Tie-rod End		30354
	1.6 2.0 2.0 CRDi	04.04 - 04.04 - 04.04 -	
	Trag-/Führungsgelenk / Support-/ Steering Link		15446 54530-31600
	1.6 2.0 2.0 CRDi	04.04 - 04.04 - 04.04 -	
	Trag-/Führungsgelenk / Support-/ Steering Link		29666 54530-31600
	1.6 2.0 2.0 CRDi	04.04 - 04.04 - 04.04 -	

CLARUS (K9A) 07.96 -





	Spurstangenkopf / Tie-rod End Gewindeart: mit Rechtsgewinde / Thread Type: with right-hand thread Gewindemaß / Thread Size: M14x1,5		11816
	ALL TYPES		
	Trag-/Führungsgelenk / Support-/ Steering Link		24683 OK201-34-550C
	ALL TYPES		



KIA

CLARUS (K9A)





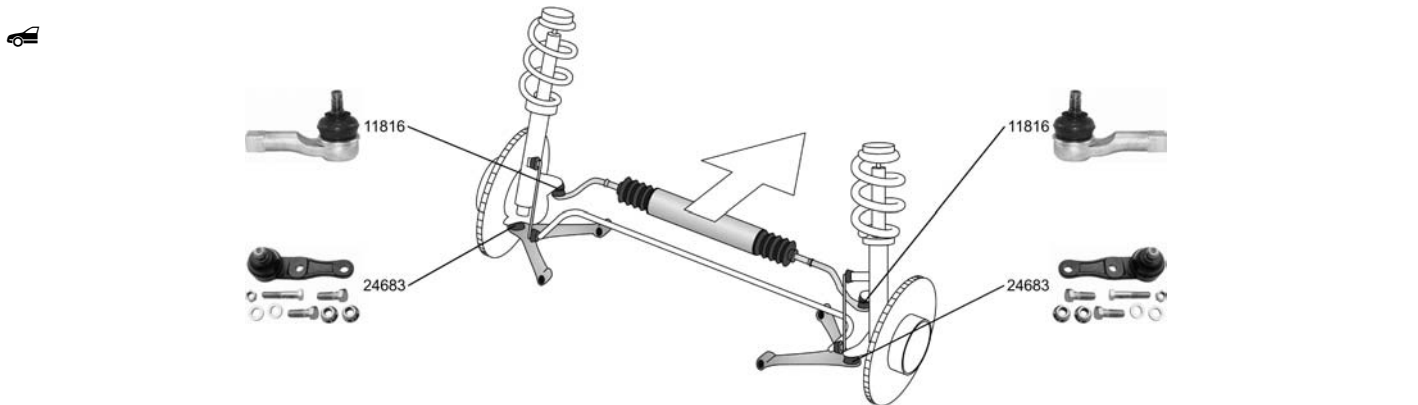

07.96 -

 Faltenbalgsatz, Lenkung / Bellow Kit, steering system ALL TYPES		30241 
---	---	---

CLARUS Kombi/Estate/Break (GC)

05.98 -



Spurstangenkopf / Tie-rod End Gewindeart: mit Rechtsgewinde / Thread Type: with right-hand thread Gewindemaß / Thread Size:M14x1,5 ALL TYPES		11816 
Trag-/Führungsgelenk / Support-/ Steering Link ALL TYPES		24683 OK201-34-550C 
Faltenbalgsatz, Lenkung / Bellow Kit, steering system ALL TYPES		30241 







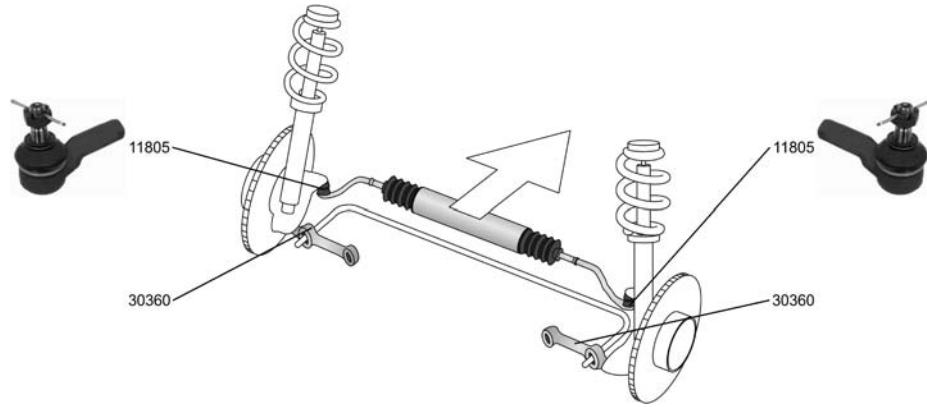

OE

KIA

PRIDE (DA)

01.90 -





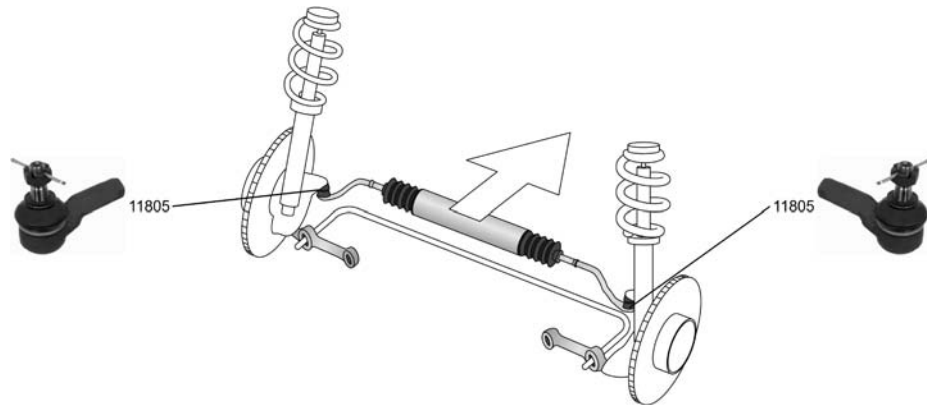

<p>Spurstangenkopf / Tie-rod End Gewindeart: mit Rechtsgewinde / Thread Type: with right-hand thread Gewindemaß / Thread Size: M12x1,25</p>		<p>11805 KKY01-32-280</p>
<p>ALL TYPES</p>		
<p>Lenker, Radaufhängung / Track Control Arm ALL TYPES</p>		<p>30360 KKY0134390A</p>
<p>Faltenbaldsatz, Lenkung / Bellow Kit, steering system</p>		<p>30193 KK150-32-125</p>
<p>1.3 16V, 47 kW 10.96 - 1.3 16V, 53 kW 01.90 -</p>		

PRIDE Kombi/Estate/Break

08.99 -



<p>Spurstangenkopf / Tie-rod End Gewindeart: mit Rechtsgewinde / Thread Type: with right-hand thread Gewindemaß / Thread Size: M12x1,25</p>		<p>11805 KKY01-32-280</p>
<p>ALL TYPES</p>		
<p>Faltenbaldsatz, Lenkung / Bellow Kit, steering system ALL TYPES</p>		<p>30193 KK150-32-125</p>
		





OE

KIA

SEPHIA (FA)

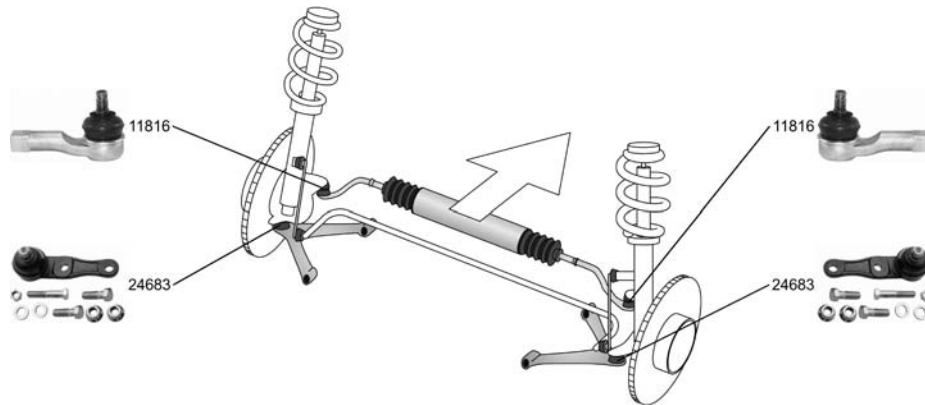
01.95 - 10.97





<p>Spurstangenkopf / Tie-rod End Gewindeart: mit Rechtsgewinde / Thread Type: with right-hand thread Gewindemaß / Thread Size:M14x1,5</p>	↔	<p>11816</p> 
<p>ALL TYPES</p>		<p>24683 OK201-34-550C</p> 
<p>Trag-/Führungsgelenk / Support-/ Steering Link ALL TYPES</p>	↕↔	

SEPHIA Stufenheck/Saloon/avec coffre (FA)

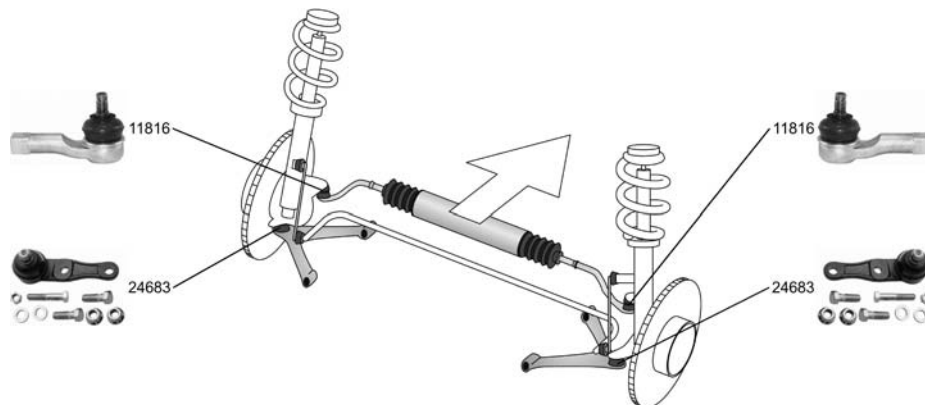
09.93 - 10.97



<p>Spurstangenkopf / Tie-rod End Gewindeart: mit Rechtsgewinde / Thread Type: with right-hand thread Gewindemaß / Thread Size:M14x1,5</p>	↔	<p>11816</p> 
<p>ALL TYPES</p>		<p>24683 OK201-34-550C</p> 
<p>Trag-/Führungsgelenk / Support-/ Steering Link ALL TYPES</p>	↕↔	







OE

KIA

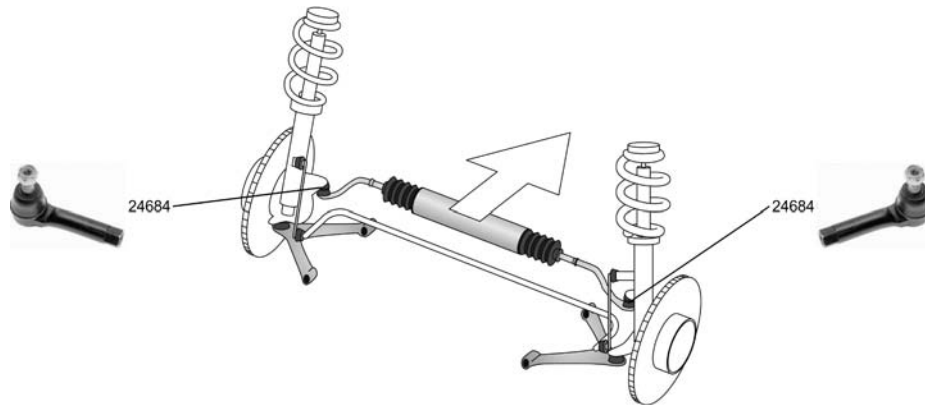
SHUMA (FB)

10.97 -





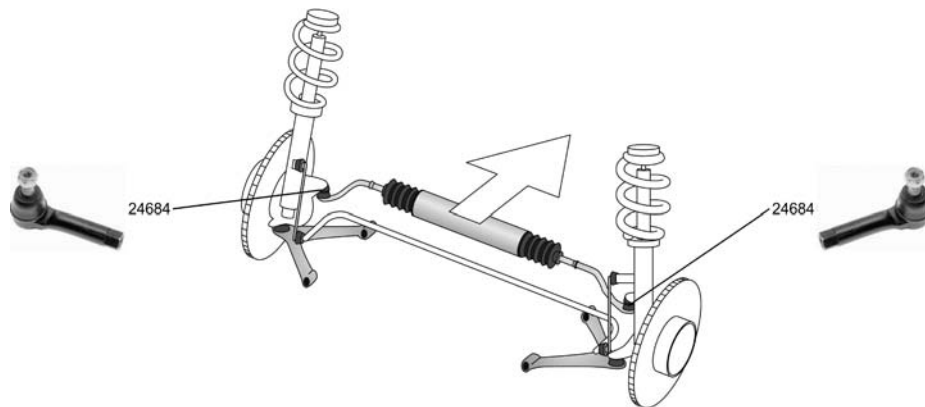

<p>Spurstangenkopf / Tie-rod End 1.5 i 16V 1.8 i 16V</p>	<p>10.97 - 10.97 -</p> <p></p>	<p>24684 OK9A2-32-280</p> 
<p>Faltenbalgsatz, Lenkung / Bellow Kit, steering system 1.5 i 16V 1.8 i 16V</p>	<p>10.97 - 10.97 -</p> <p></p>	<p>30241</p> 

SHUMA Stufenheck (FB)

03.96 -



<p>Spurstangenkopf / Tie-rod End ALL TYPES</p>	<p></p>	<p>24684 OK9A2-32-280</p> 
<p>Faltenbalgsatz, Lenkung / Bellow Kit, steering system ALL TYPES</p>	<p></p>	<p>30241</p> 





OE

KIA

SHUMA II (FB)

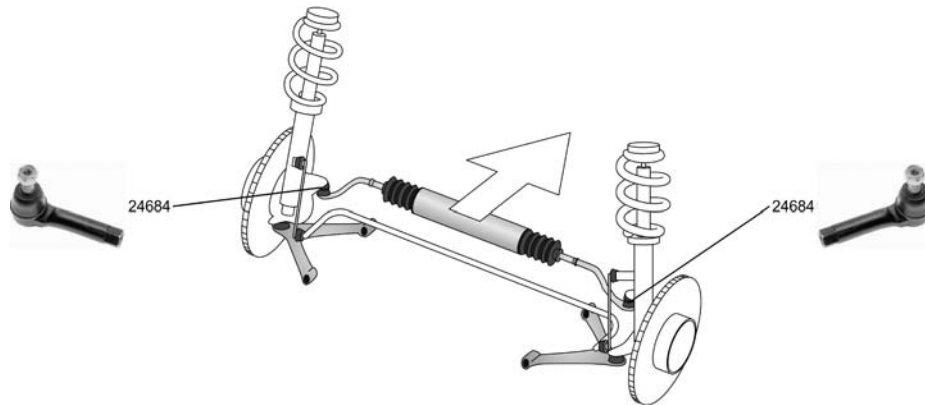
05.01 - 08.04





<p>Spurstangenkopf / Tie-rod End</p>		<p>24684 OK9A2-32-280</p>
<p>1.6 1.8</p>	<p>05.01 - 08.04 04.03 - 08.04</p>	

SHUMA II Stufenheck (FB)

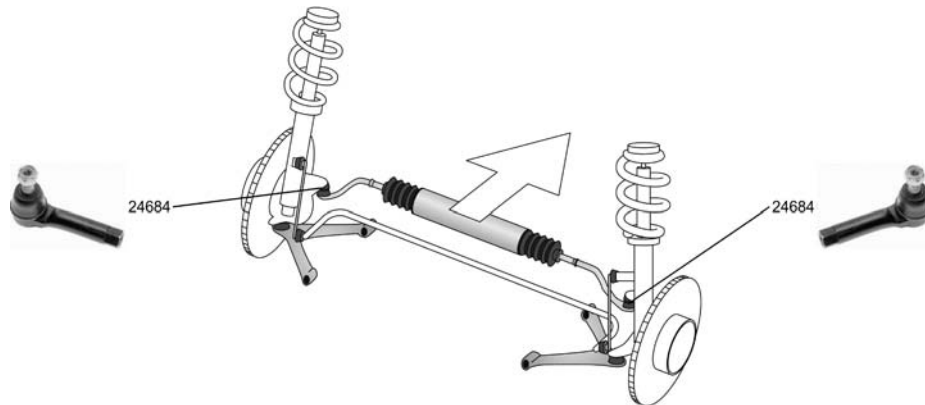
05.01 - 05.04



<p>Spurstangenkopf / Tie-rod End</p>		<p>24684 OK9A2-32-280</p>
<p>ALL TYPES</p>		

Artikelnummer Article No.	Seite Page	Hersteller Manufacturer	Artikelnummer Article No.	Seite Page	Hersteller Manufacturer
11805 Ⓢ	3	KIA			
Spurstangenkopf / Tie-rod End					
11816 Ⓢ	1 2 4	KIA			
Spurstangenkopf / Tie-rod End					
15446 ▲▼Ⓢ	1	KIA			
Trag-/Führungsgelenk / Support-/ Steering Link					
24683 ▼Ⓢ	1 2 4	KIA			
Trag-/Führungsgelenk / Support-/ Steering Link					
24684 Ⓢ	5 6	KIA			
Spurstangenkopf / Tie-rod End					
29666 ▼Ⓢ	1	KIA			
Trag-/Führungsgelenk / Support-/ Steering Link					
30193 Ⓢ	3	KIA			
Faltenbalgsatz, Lenkung / Bellow Kit, steering system					
30241 Ⓢ	2 5	KIA			
Faltenbalgsatz, Lenkung / Bellow Kit, steering system					
30354 Ⓢ	1	KIA			
Spurstangenkopf / Tie-rod End					
30360 ▼Ⓢ	3	KIA			
Lenker, Radaufhängung / Track Control Arm					

Vergleichsliste / Cross reference list

Vergleichs-Nr. Compare No.	Artikelnummer Article No.	Vergleichs-Nr. Compare No.	Artikelnummer Article No.	Vergleichs-Nr. Compare No.	Artikelnummer Article No.
KIA					
54530-31600	15446				
54530-31600	29666				
KK150-32-125	30193				
KKY01-32-280	11805				
KKY0134390A	30360				
OK201-34-550C	24683				
OK9A2-32-280	24684				

Neuaufnahmen / New to range

Artikelnummer Article No.	Seite Page	Hersteller Manufacturer	Artikelnummer Article No.	Seite Page	Hersteller Manufacturer
24683 ▾⊕	1 2 4	KIA			
24684 ⊕♂	5 6	KIA			
29666 ▾⊕	1	KIA			
30193 ⊕	3	KIA			
30241 ⊕	2 5	KIA			
30354 ⊕	1	KIA			
30360 ▾⊕	3	KIA			

Geänderte Bestellnummer / Amended part numbers

Artikelnummer alt Article No. old	Artikelnummer neu Article No. new	Artikelnummer alt Article No. old	Artikelnummer neu Article No. new	Artikelnummer alt Article No. old	Artikelnummer neu Article No. new
15446	29666				

Geänderte Bestellnummer / Amended part numbers

Artikelnummer neu Article No. new	Artikelnummer alt Article No. old	Artikelnummer neu Article No. new	Artikelnummer alt Article No. old	Artikelnummer neu Article No. new	Artikelnummer alt Article No. old
29666	15446				