





















OE

JAGUAR

S-TYPE (CCX)



01.99 -

	Spurstangenkopf / Tie-rod End ALL TYPES	 ->Chass. M45254	26979	XR8 1770
				
	Spurstangenkopf / Tie-rod End ALL TYPES	 ->Chass. M45254	26983	XR8 1771
				
	Spurstangenkopf / Tie-rod End radseitig / Wheel Side Innengewinde [mm] / Inner Thread [mm]:M14x1,5 Gewindemaß / Thread Size:M12x1,75 ALL TYPES	 Chass. M45255->	29425	C2C 20177
				
	Spurstangenkopf / Tie-rod End radseitig / Wheel Side Innengewinde [mm] / Inner Thread [mm]:M14x1,5 Gewindemaß / Thread Size:M12x1,75 ALL TYPES	 Chass. M45255->	29426	C2C 20176
				
	Lagerung, Lenker / Mounting, wishbone ALL TYPES		29783	C2C 26581
	Lagerung, Lenker / Mounting, wishbone ALL TYPES	 Chass. M45255->	29784	C2C 4437
	Stange/Strebe, Stabilisator / Rod/Strut, stabiliser ohne Zubehör / without accessories ALL TYPES	 Chass. M45255->	29431	C2C 18573
				
	Stange/Strebe, Stabilisator / Rod/Strut, stabiliser ALL TYPES		29427	C2C 18572
				
	Stange/Strebe, Stabilisator / Rod/Strut, stabiliser ALL TYPES		29428	C2C 18571
				

XJ

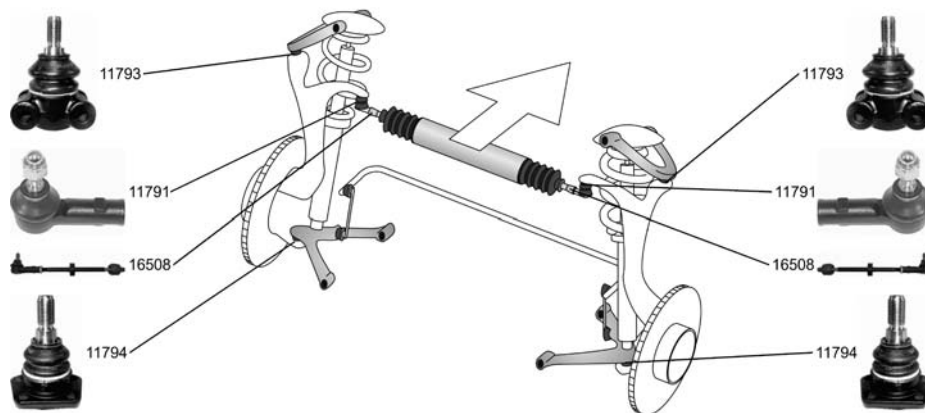
07.68 - 02.93









Spurstange / Tie Rod, steering für / for:ZF	 Chass. 107865->	16508	JLM 409
6 3.4	05.75 - 10.86		
6 4.2, 151 kW	09.79 - 12.87		
12 H.E.	09.81 - 12.92		
6 4.2, 130 kW	09.85 - 12.86		
6 4.2, 133 kW	09.85 - 12.86		
12 5.3, 187 kW	08.86 - 09.89		
Sovereign V12	07.85 - 12.92		



JAGUAR

XJ







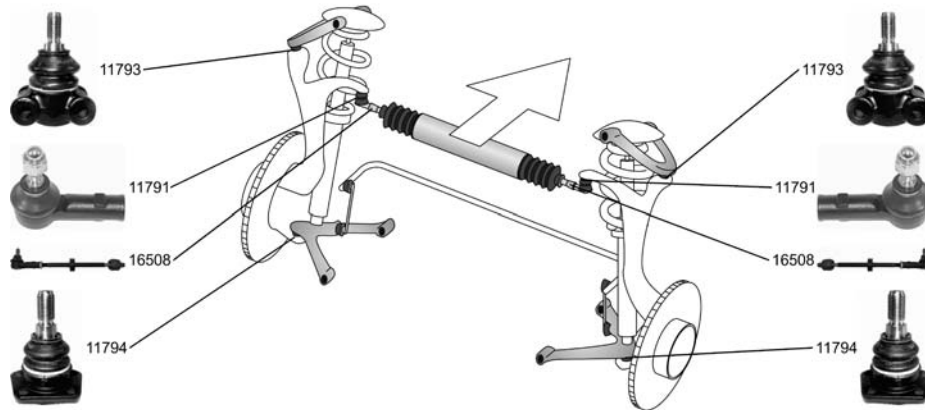

07.68 - 02.93

 Spurstangenkopf / Tie-rod End Gewindeart: mit Rechtsgewinde / Thread Type: with right-hand thread Gewindemaß / Thread Size: M14x1,5		11791 JLM 9660 
6 3.4 6 4.2, 151 kW 12 H.E. 6 4.2, 130 kW 6 4.2, 133 kW 12 5.3, 187 kW Sovereign V12	05.75 - 10.86 09.79 - 12.87 09.81 - 12.92 09.85 - 12.86 09.85 - 12.86 08.86 - 09.89 07.85 - 12.92	Chass. 107865->
Trag-/Führungsgelenk / Support-/ Steering Link ALL TYPES		11793 CAC 9938 
Trag-/Führungsgelenk / Support-/ Steering Link ALL TYPES		11794 CAC 9937 

XJ (XJ 40, 81)

10.86 - 11.94





Spurstange / Tie Rod, steering für / for:ZF ALL TYPES		16508 JLM 409 
Spurstangenkopf / Tie-rod End Gewindeart: mit Rechtsgewinde / Thread Type: with right-hand thread Gewindemaß / Thread Size: M14x1,5 ALL TYPES		11791 JLM 9660 
Trag-/Führungsgelenk / Support-/ Steering Link ALL TYPES		11793 CAC 9938 
Trag-/Führungsgelenk / Support-/ Steering Link ALL TYPES		11794 CAC 9937 



OE







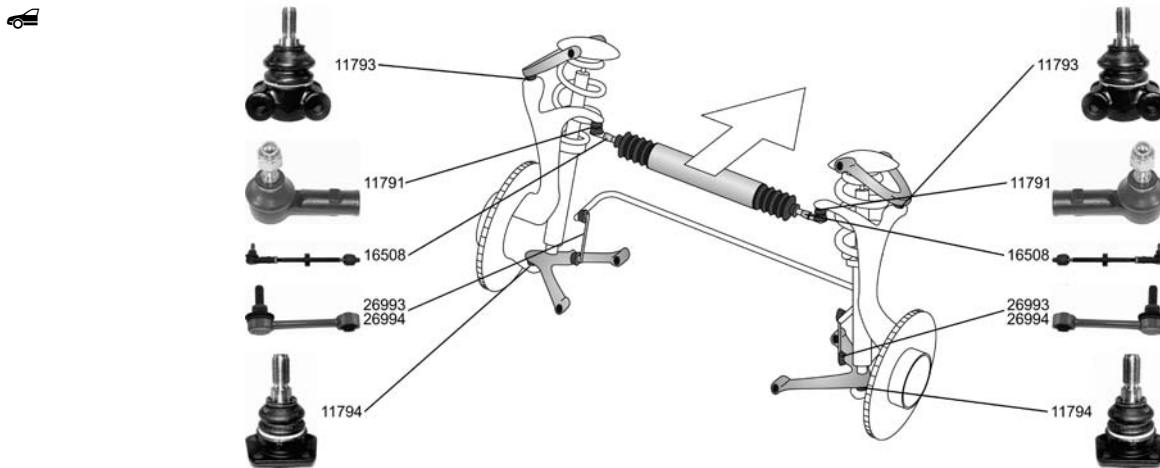

JAGUAR

XJ (XJ 40, 81) 10.86 - 11.94

	Lagerung, Lenker / Mounting, wishbone	▲↔	11796	CBC 5523
	ALL TYPES ausser/except for : V12 6.0			
	03.93 - 11.94			

XJ (X300) 11.94 - 07.97



	Spurstange / Tie Rod, steering für / for:ZF	↔	16508	JLM 409
	ALL TYPES			
				
	Spurstangenkopf / Tie-rod End Gewindeart: mit Rechtsgewinde / Thread Type: with right-hand thread Gewindemaß / Thread Size:M14x1,5	↔♂	11791	JLM 9660
	ALL TYPES			
				
	Trag-/Führungsgelenk / Support-/ Steering Link	▲↔	11793	CAC 9938
	ALL TYPES			
				
	Trag-/Führungsgelenk / Support-/ Steering Link	▼↔	11794	CAC 9937
	ALL TYPES			
				
	Lagerung, Lenker / Mounting, wishbone	▲↔	11796	CBC 5523
	6 3.2 11.94 - 07.97 6 Sovereign 4.0 11.94 - 07.97 R Super Charged 4.0 11.94 - 07.97			
				
	Stange/Strebe, Stabilisator / Rod/Strut, stabiliser	↔	26993	MJA 2105AG
	ALL TYPES			
	->Chass. 853935			
	Stange/Strebe, Stabilisator / Rod/Strut, stabiliser	↔	26994	MNC 2105AA
	ALL TYPES			
	Chass. 853936->			







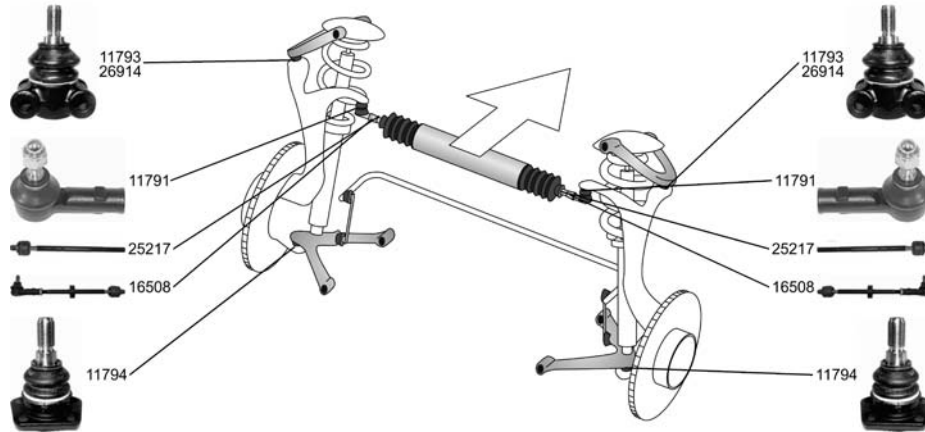

JAGUAR

XJ (NAW, NBW)

07.97 - 05.03



<p>Spurstange / Tie Rod, steering für / for:ZF R 4.0</p>	<p>↔</p>	<p>16508 JLM 409</p> 
<p>Spurstangenkopf / Tie-rod End Gewindeart: mit Rechtsgewinde / Thread Type: with right-hand thread Gewindemaß / Thread Size:M14x1,5 ALL TYPES</p>	<p>↗</p>	<p>11791 JLM 9660</p> 
<p>Axialgelenk, Spurstange / Axial Rod, tie rod Gewindeart: mit Rechtsgewinde / Thread Type: with right-hand thread Gewindemaß / Thread Size:M14x1,5 8 3.2 8 4.0</p>	<p>↗ ↔</p>	<p>25217</p> 
<p>Trag-/Führungsgelenk / Support-/ Steering Link ALL TYPES</p>	<p>▲ ↔</p>	<p>11793 CAC 9938</p> 
<p>Trag-/Führungsgelenk / Support-/ Steering Link ALL TYPES</p>	<p>▼ ↔</p>	<p>11794 CAC 9937</p> 
<p>Trag-/Führungsgelenk / Support-/ Steering Link Konusmaß [mm] / Cone Size [mm]:16 ohne Befestigungsmaterial / without fastening material ALL TYPES</p>	<p>▲ ↔</p> <p>Chass. 812317 - Chass. F59525</p>	<p>26914 JLM 21380</p> 











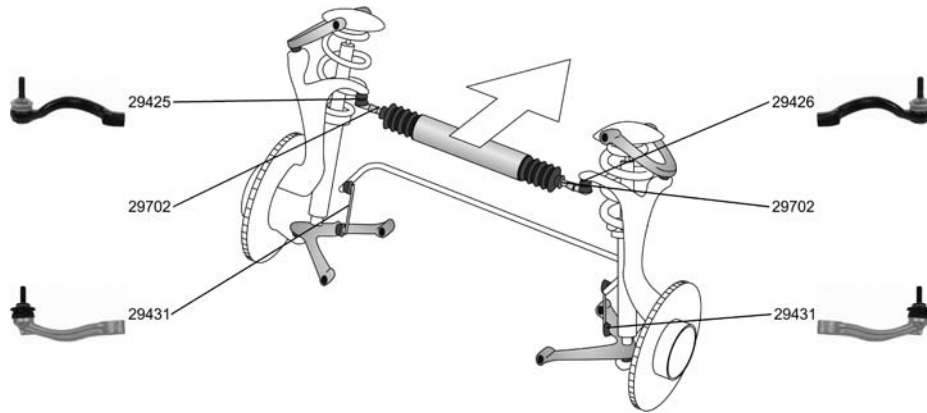





OE

JAGUAR

XJ

05.03 -





Spurstangenkopf / Tie-rod End radseitig / Wheel Side Innengewinde [mm] / Inner Thread [mm]:M14x1,5 Gewindemaß / Thread Size:M12x1,75		29425 C2C 20177 
6 3.0 05.03 - 8 3.5 05.03 - 8 4.2 05.03 - R 4.2 05.03 -		
Spurstangenkopf / Tie-rod End radseitig / Wheel Side Innengewinde [mm] / Inner Thread [mm]:M14x1,5 Gewindemaß / Thread Size:M12x1,75		29426 C2C 20176 
6 3.0 05.03 - 8 3.5 05.03 - 8 4.2 05.03 - R 4.2 05.03 -		
Axialgelenk, Spurstange / Axial Rod, tie rod radseitig / Wheel Side Gewindemaß / Thread Size:M16x1,5 Gewindemaß / Thread Size:M14x1,5		29702 C2C 29620 C2C 29621
6 3.0 05.03 - 8 3.5 05.03 - 8 4.2 05.03 - R 4.2 05.03 -		
Lagerung, Lenker / Mounting, wishbone ALL TYPES	 Chass. G00442->	29783 C2C 26581
Lagerung, Lenker / Mounting, wishbone ALL TYPES	 Chass. G00442->	29784 C2C 4437
Lagerung, Lenker / Mounting, wishbone ALL TYPES	 Chass. G00442->	29785 C2C 18350
Stange/Strebe, Stabilisator / Rod/Strut, stabiliser ohne Zubehör / without accessories		29431 C2C 18573 
6 3.0 05.03 - 8 3.5 05.03 - 8 4.2 05.03 - R 4.2 05.03 -		
Achskörperlager / Mounting, axle body ALL TYPES	 Chass. G00442->	29781 C2C 2941
Achskörperlager / Mounting, axle body ALL TYPES	 Chass. G00442->	29782 C2C 2942
Stange/Strebe, Stabilisator / Rod/Strut, stabiliser		29427 C2C 18572 
6 3.0 05.03 - 8 3.5 05.03 - 8 4.2 05.03 - R 4.2 05.03 -	Chass. G00442->	



JAGUAR

XJ





05.03 -

	Stange/Strebe, Stabilisator / Rod/Strut, stabiliser			29428	C2C 18571
	6 3.0	05.03 -	Chass. G00442->		
	8 3.5	05.03 -			
	8 4.2	05.03 -			
	R 4.2	05.03 -			

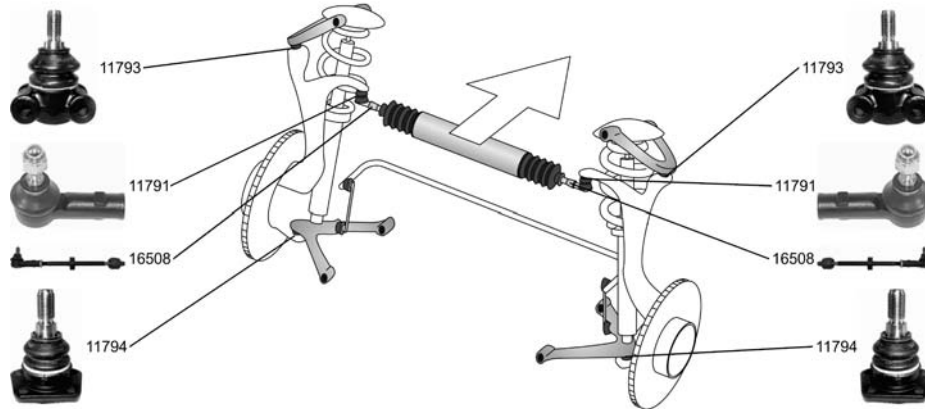
XJS Coupe

09.75 - 03.96



Spurstange / Tie Rod, steering für / for:ZF			16508	JLM 409
3.6	10.83 - 05.92	Chass. 107865->		
4.0	05.91 - 03.96			
5.3 H.E., 194 kW	01.86 - 12.89			
5.3, 197 kW	01.86 - 12.89			
5.3, 202 kW	01.88 - 06.91			
5.3, 207 kW	05.91 - 08.93			
5.3, 211 kW	01.88 - 05.92			
6.0	05.93 - 03.96			
5.3 H.E., 217 kW	07.81 - 12.87			
Spurstangenkopf / Tie-rod End Gewindeart: mit Rechtsgewinde / Thread Type: with right-hand thread Gewindemaß / Thread Size:M14x1,5				
3.6	10.83 - 05.92	Chass. 107865->		
4.0	05.91 - 03.96			
5.3 H.E., 194 kW	01.86 - 12.89			
5.3, 197 kW	01.86 - 12.89			
5.3, 202 kW	01.88 - 06.91			
5.3, 207 kW	05.91 - 08.93			
5.3, 211 kW	01.88 - 05.92			
6.0	05.93 - 03.96			
5.3 H.E., 217 kW	07.81 - 12.87			
Trag-/Führungsgelenk / Support-/ Steering Link ALL TYPES				
Trag-/Führungsgelenk / Support-/ Steering Link ALL TYPES			11794	CAC 9937







OE

JAGUAR

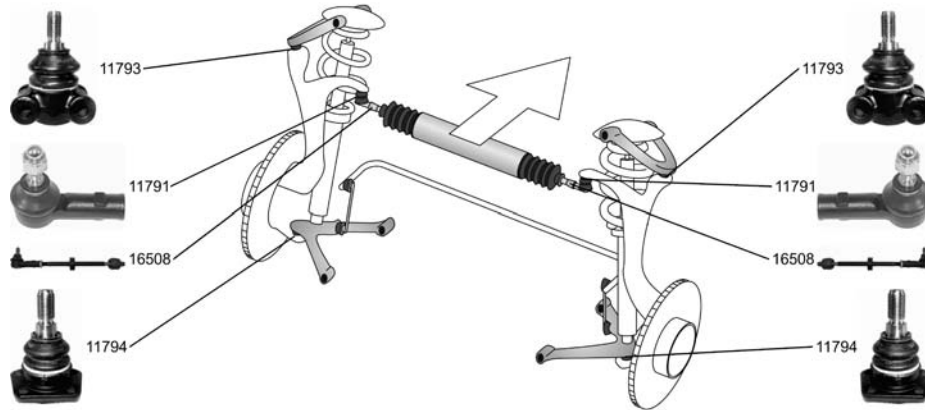
XJSC Cabrio/Convertible

07.85 - 03.96







Spurstange / Tie Rod, steering für / for:ZF ALL TYPES ausser/except for : 3.6, 136 kW 08.87 - 05.91 3.6, 156 kW 08.87 - 05.91	↔	16508 JLM 409 
Spurstangenkopf / Tie-rod End Gewindeart: mit Rechtsgewinde / Thread Type: with right-hand thread Gewindemaß / Thread Size:M14x1,5 ALL TYPES ausser/except for : 3.6, 136 kW 08.87 - 05.91 3.6, 156 kW 08.87 - 05.91	↔ ♂	11791 JLM 9660 
Trag-/Führungsgelenk / Support-/ Steering Link ALL TYPES	↕ ↔	11793 CAC 9938 
Trag-/Führungsgelenk / Support-/ Steering Link ALL TYPES	↕ ↔	11794 CAC 9937 

XK Coupe

03.06 -



Spurstangenkopf / Tie-rod End radseitig / Wheel Side Innengewinde [mm] / Inner Thread [mm]:M14x1,5 Gewindemaß / Thread Size:M12x1,75 ALL TYPES	↔ ♂	29425 C2C 20177 
Spurstangenkopf / Tie-rod End radseitig / Wheel Side Innengewinde [mm] / Inner Thread [mm]:M14x1,5 Gewindemaß / Thread Size:M12x1,75 ALL TYPES	↔ ♂	29426 C2C 20176 
Lagerung, Lenker / Mounting, wishbone ALL TYPES	↕ ↔ ⊕ ♂	29785 C2C 18350 
Stange/Strebe, Stabilisator / Rod/Strut, stabiliser ohne Zubehör / without accessories ALL TYPES	↔	29431 C2C 18573 
Stange/Strebe, Stabilisator / Rod/Strut, stabiliser ALL TYPES	↔	29427 C2C 18572 



OE

JAGUAR

















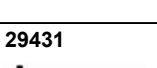

XK Coupe

03.06 -

	Stange/Strebe, Stabilisator / Rod/Strut, stabiliser		29428	C2C 18571
	ALL TYPES			

XK Cabriolet





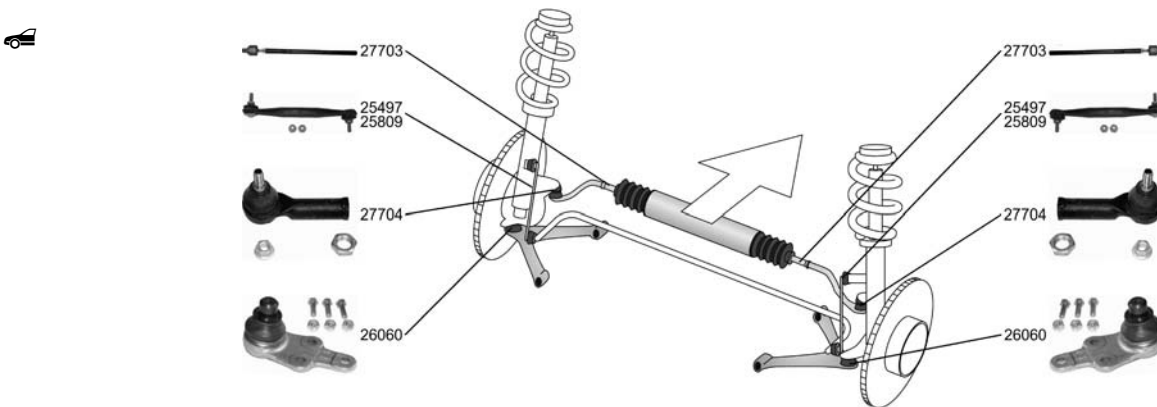

03.06 -

	Spurstangenkopf / Tie-rod End radseitig / Wheel Side Innengewinde [mm] / Inner Thread [mm]:M14x1,5 Gewindemaß / Thread Size:M12x1,75		29425	C2C 20177
	ALL TYPES			
	Spurstangenkopf / Tie-rod End radseitig / Wheel Side Innengewinde [mm] / Inner Thread [mm]:M14x1,5 Gewindemaß / Thread Size:M12x1,75		29426	C2C 20176
	ALL TYPES			
	Lagerung, Lenker / Mounting, wishbone		29785	C2C 18350
	ALL TYPES			
	Stange/Strebe, Stabilisator / Rod/Strut, stabiliser ohne Zubehör / without accessories		29431	C2C 18573
	ALL TYPES			
	Stange/Strebe, Stabilisator / Rod/Strut, stabiliser		29427	C2C 18572
	ALL TYPES			
	Stange/Strebe, Stabilisator / Rod/Strut, stabiliser		29428	C2C 18571
	ALL TYPES			

X-TYPE (CF1)

06.01 -



	Spurstangenkopf / Tie-rod End mit Zubehör / With accessories		27704	C2S 12013
	ALL TYPES			
	Axialgelenk, Spurstange / Axial Rod, tie rod		27703	
	ALL TYPES		für Lenkgetriebe-ID / For steering rack ID:ZF 7831 974 179 für Lenkgetriebe-ID / For steering rack ID:ZF 7831 974 180 für Lenkgetriebe-ID / For steering rack ID:ZF 7831 993 105 für Lenkgetriebe-ID / For steering rack ID:ZF 7831 993 106	







OE

JAGUAR

X-TYPE (CF1)





06.01 -

	Trag-/Führungsgelenk / Support-/ Steering Link mit Zubehör / With accessories	↔	26060 1X43 3395 AB
ALL TYPES			
	Stange/Strebe, Stabilisator / Rod/Strut, stabiliser Pendelstange / Suspension Rod mit Zubehör / With accessories	↔	25497 C2S 26883
2.0 V6 2.5 V6 3.0 V6 2.0 D 2.2 D	03.02 - 10.05 06.01 - 06.01 - 07.03 - 10.05 10.05 -	Chass. D14966->	
	Stange/Strebe, Stabilisator / Rod/Strut, stabiliser Pendelstange / Suspension Rod	↔	25809 C2S 3248
2.0 V6 2.5 V6 3.0 V6	03.02 - 10.05 06.01 - 06.01 -	->Chass. D14965	
	Stange/Strebe, Stabilisator / Rod/Strut, stabiliser Länge innen [mm] / Inner Length [mm]:58	↔	29573 C2S 40709
ALL TYPES			

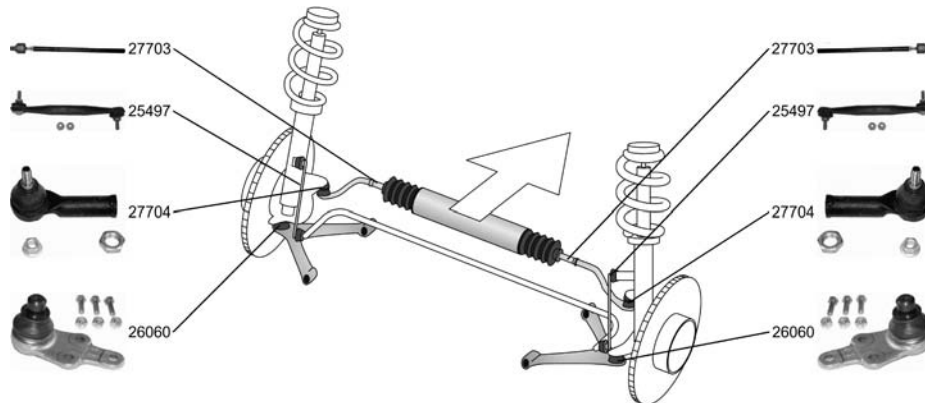
X-TYPE Estate

02.04 -



Spurstangenkopf / Tie-rod End mit Zubehör / With accessories	↔ ↗	27704 C2S 12013
ALL TYPES		
Axialgelenk, Spurstange / Axial Rod, tie rod	↔ ↗	27703
ALL TYPES	für Lenkgetriebe-ID / For steering rack ID:ZF 7831 974 179 für Lenkgetriebe-ID / For steering rack ID:ZF 7831 974 180 für Lenkgetriebe-ID / For steering rack ID:ZF 7831 993 105 für Lenkgetriebe-ID / For steering rack ID:ZF 7831 993 106	
Trag-/Führungsgelenk / Support-/ Steering Link mit Zubehör / With accessories	↔	26060 1X43 3395 AB
ALL TYPES		
Stange/Strebe, Stabilisator / Rod/Strut, stabiliser Pendelstange / Suspension Rod mit Zubehör / With accessories	↔	25497 C2S 26883
ALL TYPES		



JAGUAR

X-TYPE Estate







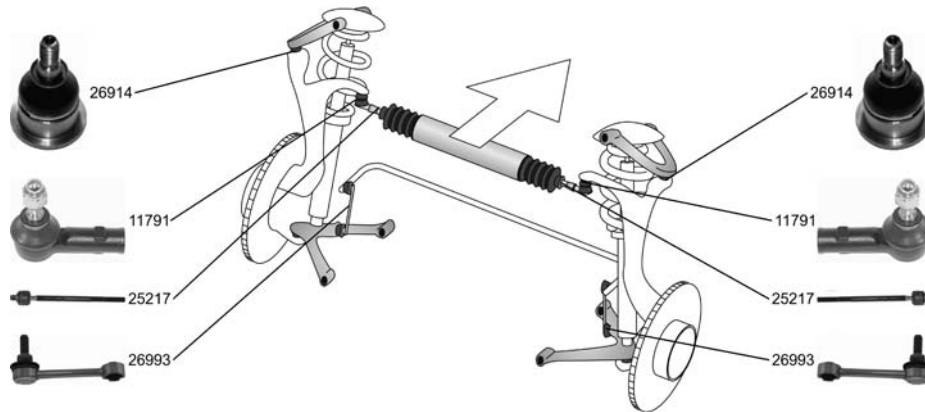

02.04 -

	Stange/Strebe, Stabilisator / Rod/Strut, stabiliser Länge innen [mm] / Inner Length [mm]:58		29573	C2S 40709
	ALL TYPES			

XK 8 Coupe (QEY)

03.96 -



Spurstangenkopf / Tie-rod End Gewindeart: mit Rechtsgewinde / Thread Type: with right-hand thread Gewindemaß / Thread Size:M14x1,5		11791 JLM 9660
4.0	03.96 - .	
Axialgelenk, Spurstange / Axial Rod, tie rod Gewindeart: mit Rechtsgewinde / Thread Type: with right-hand thread Gewindemaß / Thread Size:M14x1,5		25217
4.0	03.96 - .	
Trag-/Führungsgelenk / Support-/ Steering Link Konusmaß [mm] / Cone Size [mm]:16 ohne Befestigungsmaterial / without fastening material		26914 JLM 21380
ALL TYPES		
Stange/Strebe, Stabilisator / Rod/Strut, stabiliser		26993 MJA 2105AG
ALL TYPES		









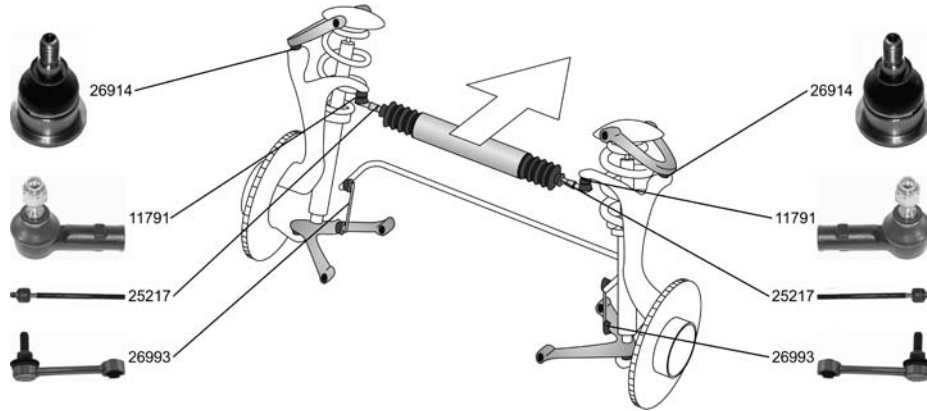

OE

JAGUAR

XK 8 Convertible (QDV)

03.96 -



<p>Spurstangenkopf / Tie-rod End Gewindeart: mit Rechtsgewinde / Thread Type: with right-hand thread Gewindemaß / Thread Size:M14x1,5 4.0 03.96 - .</p>		<p>11791 JLM 9660</p> 
<p>Axialgelenk, Spurstange / Axial Rod, tie rod Gewindeart: mit Rechtsgewinde / Thread Type: with right-hand thread Gewindemaß / Thread Size:M14x1,5 4.0 03.96 - .</p>		<p>25217</p> 
<p>Trag-/Führungsgelenk / Support-/ Steering Link Konusmaß [mm] / Cone Size [mm]:16 ohne Befestigungsmaterial / without fastening material ALL TYPES</p>		<p>26914 JLM 21380</p> 
<p>Stange/Strebe, Stabilisator / Rod/Strut, stabiliser ALL TYPES</p>		<p>26993 MJA 2105AG</p> 

Arithmetische Liste / Part number list

Artikelnummer Article No.	Seite Page	Hersteller Manufacturer	Artikelnummer Article No.	Seite Page	Hersteller Manufacturer
11791 ♂	2 3 4 6 7 10 11	JAGUAR	29428 ♂	1 6 8	JAGUAR
Spurstangenkopf / Tie-rod End			Stange/Strebe, Stabilisator / Rod/Strut, stabiliser		
11793 ▲⊕	2 3 4 6 7	JAGUAR	29431 ⊕	1 5 7 8	JAGUAR
Trag-/Führungsgelenk / Support-/ Steering Link			Stange/Strebe, Stabilisator / Rod/Strut, stabiliser		
11794 ▼⊕	2 3 4 6 7	JAGUAR	29573 ⊕	9 10	JAGUAR
Trag-/Führungsgelenk / Support-/ Steering Link			Stange/Strebe, Stabilisator / Rod/Strut, stabiliser		
11796 ▲⊕	3	JAGUAR	29702 ⊕△	5	JAGUAR
Lagerung, Lenker / Mounting, wishbone			Axialgelenk, Spurstange / Axial Rod, tie rod		
16508 ⊕	1 2 3 4 6 7	JAGUAR	29781 ⊕⊕	5	JAGUAR
Spurstange / Tie Rod, steering			Achskörperlager / Mounting, axle body		
25217 ⊕⊕	4 10 11	JAGUAR	29782 ⊕⊕	5	JAGUAR
Axialgelenk, Spurstange / Axial Rod, tie rod			Achskörperlager / Mounting, axle body		
25497 ⊕	9	JAGUAR	29783 ▼⊕⊕⊕	1 5	JAGUAR
Stange/Strebe, Stabilisator / Rod/Strut, stabiliser			Lagerung, Lenker / Mounting, wishbone		
25809 ⊕	9	JAGUAR	29784 ▼⊕⊕⊕	1 5	JAGUAR
Stange/Strebe, Stabilisator / Rod/Strut, stabiliser			Lagerung, Lenker / Mounting, wishbone		
26060 ⊕	9	JAGUAR	29785 ▼⊕⊕♂	5 7 8	JAGUAR
Trag-/Führungsgelenk / Support-/ Steering Link			Lagerung, Lenker / Mounting, wishbone		
26914 ▲⊕	4 10 11	JAGUAR			
Trag-/Führungsgelenk / Support-/ Steering Link					
26979 ♂	1	JAGUAR			
Spurstangenkopf / Tie-rod End					
26983 ♂	1	JAGUAR			
Spurstangenkopf / Tie-rod End					
26993 ⊕	3 10 11	JAGUAR			
Stange/Strebe, Stabilisator / Rod/Strut, stabiliser					
26994 ⊕	3	JAGUAR			
Stange/Strebe, Stabilisator / Rod/Strut, stabiliser					
27703 ⊕⊕	8 9	JAGUAR			
Axialgelenk, Spurstange / Axial Rod, tie rod					
27704 ♂	8 9	JAGUAR			
Spurstangenkopf / Tie-rod End					
29425 ♂	1 5 7 8	JAGUAR			
Spurstangenkopf / Tie-rod End					
29426 ♂	1 5 7 8	JAGUAR			
Spurstangenkopf / Tie-rod End					
29427 ♂	1 5 7 8	JAGUAR			
Stange/Strebe, Stabilisator / Rod/Strut, stabiliser					

Vergleichsliste / Cross reference list

Vergleichs-Nr. Compare No.	Artikelnummer Article No.	Vergleichs-Nr. Compare No.	Artikelnummer Article No.	Vergleichs-Nr. Compare No.	Artikelnummer Article No.
JAGUAR					
	1X43 3395 AB		26060		
	C2C 18350		29785		
	C2C 18571		29428		
	C2C 18572		29427		
	C2C 18573		29431		
	C2C 20176		29426		
	C2C 20177		29425		
	C2C 26581		29783		
	C2C 2941		29781		
	C2C 2942		29782		
	C2C 29620		29702		
	C2C 29621		29702		
	C2C 4437		29784		
	C2S 12013		27704		
	C2S 26883		25497		
	C2S 3248		25809		
	C2S 40709		29573		
	CAC 9937		11794		
	CAC 9938		11793		
	CBC 5523		11796		
	JLM 21380		26914		
	JLM 409		16508		
	JLM 9660		11791		
	MJA 2105AG		26993		
	MNC 2105AA		26994		
	XR8 1770		26979		
	XR8 1771		26983		

Neuaufnahmen / New to range

Artikelnummer Article No.	Seite Page	Hersteller Manufacturer	Artikelnummer Article No.	Seite Page	Hersteller Manufacturer
11796	3	JAGUAR			
25217	4 10 11	JAGUAR			
25497	9	JAGUAR			
25809	9	JAGUAR			
26060	9	JAGUAR			
26914	4 10 11	JAGUAR			
26979	1	JAGUAR			
26983	1	JAGUAR			
26993	3 10 11	JAGUAR			
26994	3	JAGUAR			
27703	8 9	JAGUAR			
27704	8 9	JAGUAR			
29425	1 5 7	JAGUAR			
	8				
29426	1 5 7	JAGUAR			
	8				
29427	1 5 7	JAGUAR			
	8				
29428	1 6 8	JAGUAR			
29431	1 5 7	JAGUAR			
	8				
29573	9 10	JAGUAR			
29702	5	JAGUAR			
29781	5	JAGUAR			
29782	5	JAGUAR			
29783	1 5	JAGUAR			
29784	1 5	JAGUAR			
29785	5 7 8	JAGUAR			

Geänderte Bestellnummer / Amended part numbers

Artikelnummer alt Article No. old	Artikelnummer neu Article No. new	Artikelnummer alt Article No. old	Artikelnummer neu Article No. new	Artikelnummer alt Article No. old	Artikelnummer neu Article No. new
25809	25497				
26998	29428				
26999	29427				

Geänderte Bestellnummer / Amended part numbers

Artikelnummer neu Article No. new	Artikelnummer alt Article No. old	Artikelnummer neu Article No. new	Artikelnummer alt Article No. old	Artikelnummer neu Article No. new	Artikelnummer alt Article No. old
25497	25809				
29427	26999				
29428	26998				

© ZF Trading GmbH - 14.10.06