



OE

DAEWOO

Espero/Aranos (KLEJ)

10.91 - 09.99

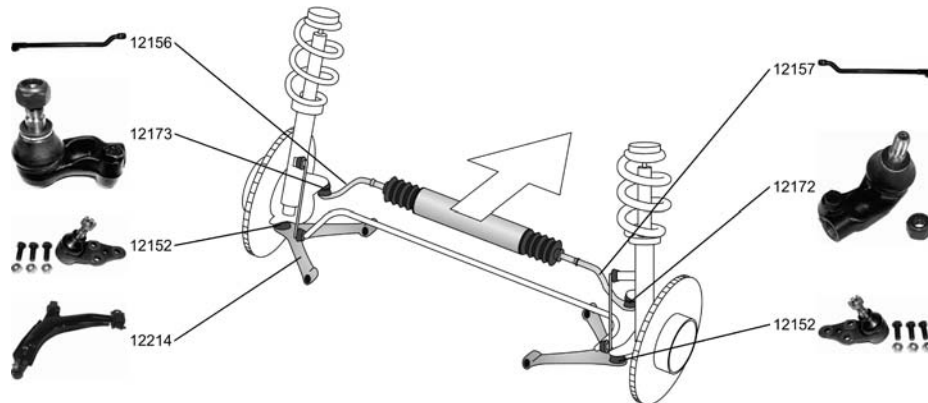



<p>Spurstange / Tie Rod, steering Gewindeart: mit Linksgewinde / Thread Type: With left-hand thread Innengewinde [mm] / Inner Thread [mm]:M16x1,5 ALL TYPES</p>		<p>12156 078 48 281</p> 
<p>Spurstange / Tie Rod, steering Gewindeart: mit Rechtsgewinde / Thread Type: with right-hand thread Innengewinde [mm] / Inner Thread [mm]:M16x1,5 ALL TYPES</p>		<p>12157 078 48 282</p> 
<p>Spurstangenkopf / Tie-rod End Gewindeart: mit Linksgewinde / Thread Type: With left-hand thread Innengewinde [mm] / Inner Thread [mm]:M16x1,5 ALL TYPES</p>		<p>12172 260 01 806</p> 
<p>Spurstangenkopf / Tie-rod End Gewindeart: mit Rechtsgewinde / Thread Type: with right-hand thread Innengewinde [mm] / Inner Thread [mm]:M16x1,5 ALL TYPES</p>		<p>12173 260 01 807</p> 
<p>Lenker, Radaufhängung / Track Control Arm mit Trag-/Führungsgelenk / With support/ steering link mit Gummilager / with rubber mounting ALL TYPES</p>		<p>12214 12219 12220</p> 
<p>Trag-/Führungsgelenk / Support-/ Steering Link mit Zubehör / With accessories Bohrung-Ø 1 / Bohrung-Ø 2 [mm] / Bore Ø 1 / Bore Ø 2 [mm]:10,0 mit Befestigungsmaterial / with fastening material ALL TYPES</p>		<p>12152 947 88 122</p> 
<p>Lagerung, Lenker / Mounting, wishbone ALL TYPES</p>		<p>12219 146/A59</p> 
<p>Faltenbalgsatz, Lenkung / Bellow Kit, steering system ALL TYPES</p>		<p>30244 5 20 540</p>
<p>Schraube, Spureinstellung / Bolt, wheel alignment Gewindeart: mit Linksgewinde / Thread Type: With left-hand thread Gewindeart: mit Rechtsgewinde / Thread Type: with right-hand thread Gewindemaß / Thread Size:M16x1,5 ALL TYPES</p>		<p>14642</p> 



DAEWOO

Espero/Aranos (KLEJ)

10.91 - 09.99

	Achskörperlager / Mounting, axle body		
	1.5 16V, 66 kW	02.95 - 06.99	
	1.8	02.95 - 09.99	
	2.0, 77 kW	02.95 - 06.99	

LANOS (KLAT)

05.97 -

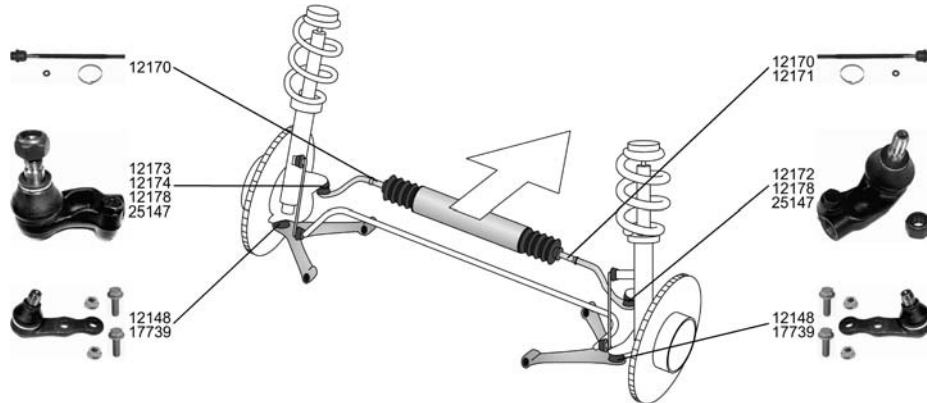

Spurstangenkopf / Tie-rod End Gewindeart: mit Linksgewinde / Thread Type: With left-hand thread Innengewinde [mm] / Inner Thread [mm]:M16x1,5 ALL TYPES		12172 260 01 806 
Spurstangenkopf / Tie-rod End Gewindeart: mit Rechtsgewinde / Thread Type: with right-hand thread Innengewinde [mm] / Inner Thread [mm]:M16x1,5 ALL TYPES		12173 260 01 807 
Spurstangenkopf / Tie-rod End Gewindeart: mit Rechtsgewinde / Thread Type: with right-hand thread Innengewinde [mm] / Inner Thread [mm]:M16x1,5 ALL TYPES		12174 
Spurstangenkopf / Tie-rod End Gewindeart: mit Rechtsgewinde / Thread Type: with right-hand thread Innengewinde [mm] / Inner Thread [mm]:M12x1,5 1.5	 ->Chass. V6066279 ->Chass. V4166925 ->Chass. V3023597	12178 
Spurstangenkopf / Tie-rod End mit Zubehör / With accessories Gewindeart: mit Rechtsgewinde / Thread Type: with right-hand thread Innengewinde [mm] / Inner Thread [mm]:M12x1,5 1.5	 Chass. V6066280-> Chass. V3023598-> Chass. V4166926->	25147 
Axialgelenk, Spurstange / Axial Rod, tie rod mit Zubehör / With accessories Gewindeart: mit Rechtsgewinde / Thread Type: with right-hand thread Aussengewinde [mm] / Outer Thread [mm]:M12x1,5 Innengewinde [mm] / Inner Thread [mm]:M14x1,5 1.5	 05.97 -	12170 
Axialgelenk, Spurstange / Axial Rod, tie rod Gewindeart: mit Rechtsgewinde / Thread Type: with right-hand thread 1.5	 05.97 -	12171 









OE

DAEWOO

LANOS (KLAT)





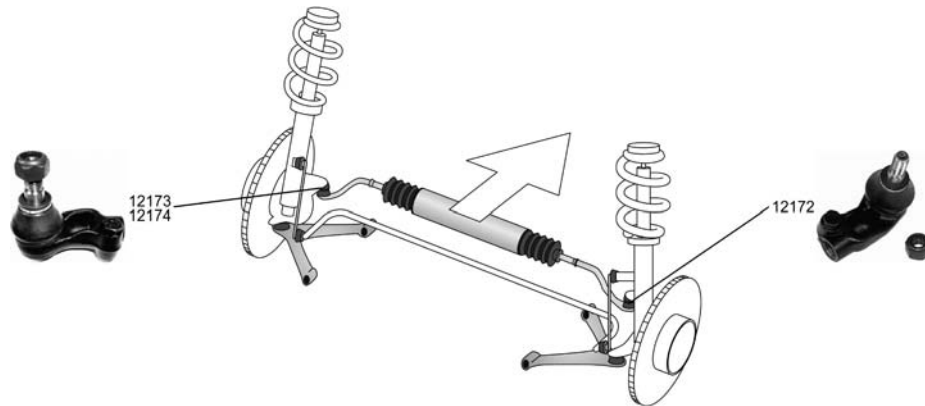

05.97 -

 Trag-/Führungsgelenk / Support-/ Steering Link mit Befestigungsmaterial / with fastening material 1.5	05.97 -	 ->Chass. V3023597	12148 
	05.97 -	 Chass. V6066280-> Chass. V4166926-> Chass. V3023598->	17739 
Faltenbalgsatz, Lenkung / Bellow Kit, steering system ALL TYPES			30244 5 20 540

LANOS Stufenheck/Saloon/avec coffre (KLAT)

05.97 -



Spurstangenkopf / Tie-rod End Gewindeart: mit Linksgewinde / Thread Type: With left-hand thread Innengewinde [mm] / Inner Thread [mm]:M16x1,5 ALL TYPES		12172 260 01 806 
Spurstangenkopf / Tie-rod End Gewindeart: mit Rechtsgewinde / Thread Type: with right-hand thread Innengewinde [mm] / Inner Thread [mm]:M16x1,5 ALL TYPES		12173 260 01 807 
Spurstangenkopf / Tie-rod End Gewindeart: mit Rechtsgewinde / Thread Type: with right-hand thread Innengewinde [mm] / Inner Thread [mm]:M16x1,5 ALL TYPES		12174 
Faltenbalgsatz, Lenkung / Bellow Kit, steering system ALL TYPES		30244 5 20 540









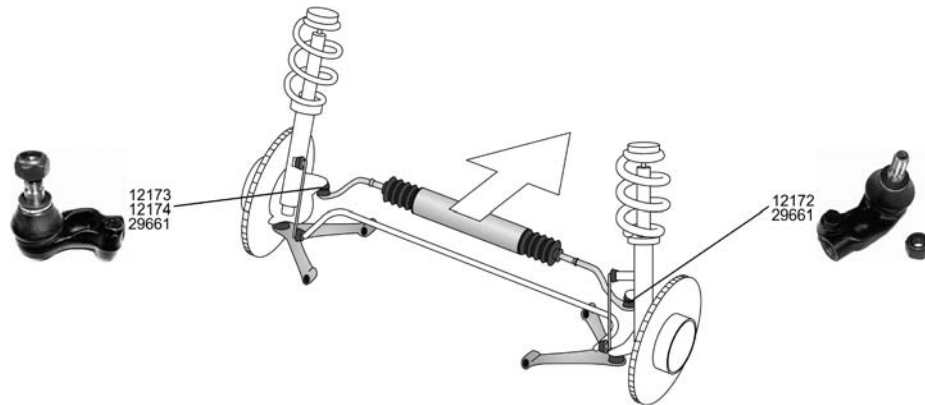

DAEWOO

LEGANZA (KLAUV)

06.97 - 12.02



<p>Spurstangenkopf / Tie-rod End Gewindeart: mit Linksgewinde / Thread Type: With left-hand thread Innengewinde [mm] / Inner Thread [mm]:M16x1,5 2.0 16V, 98 kW 06.97 - 12.02</p>		<p>12172 260 01 806</p> 
<p>Spurstangenkopf / Tie-rod End Gewindeart: mit Rechtsgewinde / Thread Type: with right-hand thread Innengewinde [mm] / Inner Thread [mm]:M16x1,5 2.0 16V, 98 kW 06.97 - 12.02</p>		<p>12173 260 01 807</p> 
<p>Spurstangenkopf / Tie-rod End Gewindeart: mit Rechtsgewinde / Thread Type: with right-hand thread Innengewinde [mm] / Inner Thread [mm]:M16x1,5 2.0 16V, 98 kW 06.97 - 12.02</p>		<p>12174</p> 
<p>Spurstangenkopf / Tie-rod End 2.0 16V, 98 kW 06.97 - 12.02</p>		<p>29661 96205809</p>
<p>Faltenbalgsatz, Lenkung / Bellow Kit, steering system 2.0 16V, 98 kW 06.97 - 12.02</p>		<p>30194 5 20 738</p> 

MATIZ (KLYA)

09.98 -

<p> Faltenbalgsatz, Lenkung / Bellow Kit, steering system ALL TYPES</p>		<p>30194 5 20 738</p> 
--	--	--



OE

DAEWOO

NEXIA (KLETN)

02.95 - 08.97

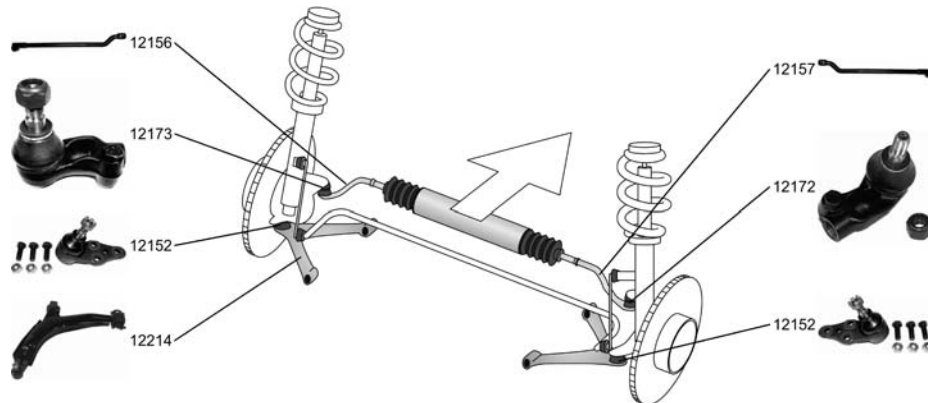



<p>Spurstange / Tie Rod, steering Gewindeart: mit Linksgewinde / Thread Type: With left-hand thread Innengewinde [mm] / Inner Thread [mm]:M16x1,5</p>		<p>12156 078 48 281</p> 
<p>1.5 02.95 - 08.97 1.5 16V 02.95 - 08.97</p>		
<p>Spurstange / Tie Rod, steering Gewindeart: mit Rechtsgewinde / Thread Type: with right-hand thread Innengewinde [mm] / Inner Thread [mm]:M16x1,5</p>		<p>12157 078 48 282</p> 
<p>1.5 02.95 - 08.97 1.5 16V 02.95 - 08.97</p>		
<p>Spurstangenkopf / Tie-rod End Gewindeart: mit Linksgewinde / Thread Type: With left-hand thread Innengewinde [mm] / Inner Thread [mm]:M16x1,5</p>		<p>12172 260 01 806</p> 
<p>1.5 02.95 - 08.97 1.5 16V 02.95 - 08.97</p>		
<p>Spurstangenkopf / Tie-rod End Gewindeart: mit Rechtsgewinde / Thread Type: with right-hand thread Innengewinde [mm] / Inner Thread [mm]:M16x1,5</p>		<p>12173 260 01 807</p> 
<p>1.5 02.95 - 08.97 1.5 16V 02.95 - 08.97</p>		
<p>Lenker, Radaufhängung / Track Control Arm mit Trag-/Führungsgelenk / With support/ steering link mit Gummilager / with rubber mounting</p>		<p>12214 12219 12220</p> 
<p>1.5 02.95 - 08.97 1.5 16V 02.95 - 08.97</p>		
<p>Trag-/Führungsgelenk / Support-/ Steering Link mit Zubehör / With accessories Bohrung-Ø 1 / Bohrung-Ø 2 [mm] / Bore Ø 1 / Bore Ø 2 [mm]:10,0 mit Befestigungsmaterial / with fastening material</p>		<p>12152 947 88 122</p> 
<p>1.5 02.95 - 08.97 1.5 16V 02.95 - 08.97</p>		
<p>Lagerung, Lenker / Mounting, wishbone</p>		<p>146/A59 12219</p> 
<p>1.5 02.95 - 08.97 1.5 16V 02.95 - 08.97</p>		
<p>Schraube, Spureinstellung / Bolt, wheel alignment Gewindeart: mit Linksgewinde / Thread Type: With left-hand thread Gewindeart: mit Rechtsgewinde / Thread Type: with right-hand thread Gewindemaß / Thread Size:M16x1,5</p>		<p>14642</p> 
<p>1.5 02.95 - 08.97 1.5 16V 02.95 - 08.97</p>		



DAEWOO

NEXIA (KLETN)









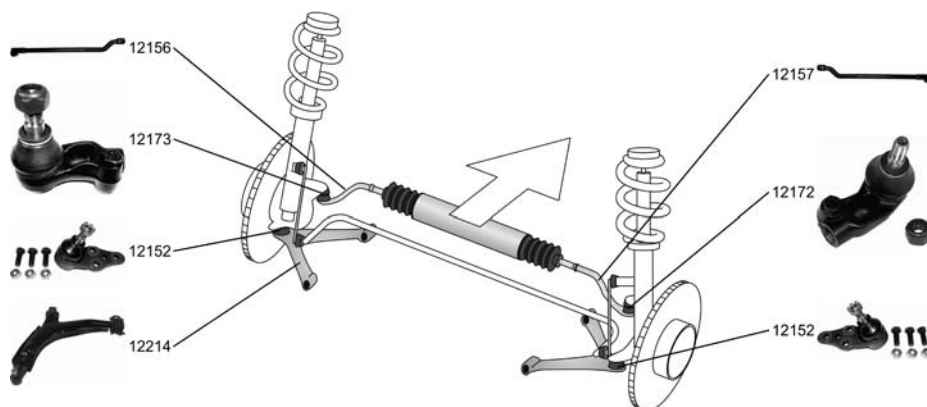



02.95 - 08.97

	Achskörperlager / Mounting, axle body		14726 
	1.5	02.95 - 08.97	

NEXIA Stufenheck/Saloon/avec coffre (KLETN)

02.95 - 08.97



	Spurstange / Tie Rod, steering Gewindeart: mit Linksgewinde / Thread Type: With left-hand thread Innengewinde [mm] / Inner Thread [mm]:M16x1,5		12156 078 48 281 
	1.5 1.5 16V	02.95 - 08.97 02.95 - 08.97	
	Spurstange / Tie Rod, steering Gewindeart: mit Rechtsgewinde / Thread Type: with right-hand thread Innengewinde [mm] / Inner Thread [mm]:M16x1,5		12157 078 48 282 
	1.5 1.5 16V	02.95 - 08.97 02.95 - 08.97	
	Spurstangenkopf / Tie-rod End Gewindeart: mit Linksgewinde / Thread Type: With left-hand thread Innengewinde [mm] / Inner Thread [mm]:M16x1,5		12172 260 01 806 
	1.5 1.5 16V	02.95 - 08.97 02.95 - 08.97	
	Spurstangenkopf / Tie-rod End Gewindeart: mit Rechtsgewinde / Thread Type: with right-hand thread Innengewinde [mm] / Inner Thread [mm]:M16x1,5		12173 260 01 807 
	1.5 1.5 16V	02.95 - 08.97 02.95 - 08.97	
	Lenker, Radaufhängung / Track Control Arm mit Trag-/Führungsgelenk / With support/ steering link mit Gummilager / with rubber mounting		12214 12219 12220 
	1.5 1.5 16V	02.95 - 08.97 02.95 - 08.97	
	Trag-/Führungsgelenk / Support-/ Steering Link mit Zubehör / With accessories Bohrung-Ø 1 / Bohrung-Ø 2 [mm] / Bore Ø 1 / Bore Ø 2 [mm]:10,0 mit Befestigungsmaterial / with fastening material		12152 947 88 122 
	1.5 1.5 16V	02.95 - 08.97 02.95 - 08.97	













OE

DAEWOO

NEXIA Stufenheck/Saloon/avec coffre (KLETN)





02.95 - 08.97

 Lagerung, Lenker / Mounting, wishbone 1.5 1.5 16V	02.95 - 08.97	  	I46/A59	12219	
	02.95 - 08.97				
Schraube, Spureinstellung / Bolt, wheel alignment Gewindeart: mit Linksgewinde / Thread Type: With left-hand thread Gewindeart: mit Rechtsgewinde / Thread Type: with right-hand thread Gewindemaß / Thread Size:M16x1,5 1.5 1.5 16V	02.95 - 08.97			14642	
	02.95 - 08.97				
 Achskörperlager / Mounting, axle body 1.5	02.95 - 08.97	 		14726	

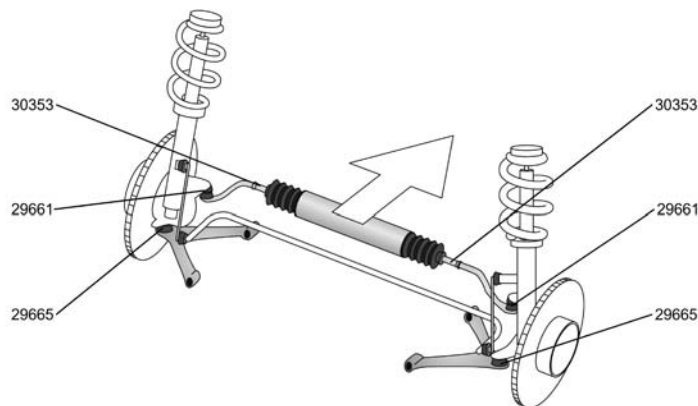
NUBIRA (KLAJ)

05.97 -



Spurstangenkopf / Tie-rod End 2.0 16V 1.6 16V	05.97 -			29661	96205809
	05.97 -				
Axialgelenk, Spurstange / Axial Rod, tie rod ALL TYPES				30353	520672
Trag-/Führungsgelenk / Support-/ Steering Link ALL TYPES		 		29665	96300648
Faltenbalgsatz, Lenkung / Bellow Kit, steering system ALL TYPES				30194	5 20 738
					



DAEWOO

NUBIRA Stufenheck/Saloon/avec coffre (KLAJ)

05.97 -

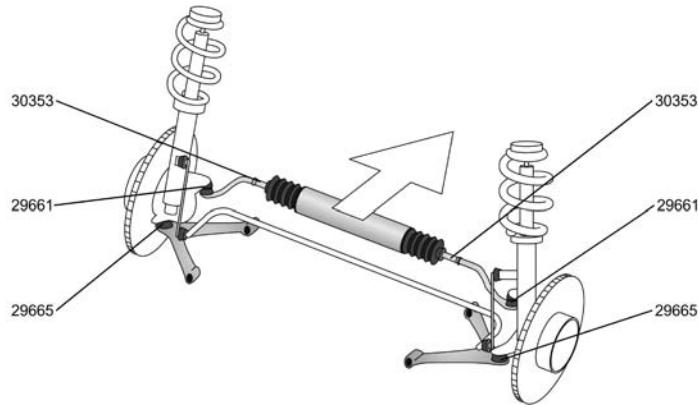

Spurstangenkopf / Tie-rod End	↔	29661	96205809
1.6 16V, 78 kW	05.97 -		
2.0 16V, 98 kW	05.97 -		
Axialgelenk, Spurstange / Axial Rod, tie rod	↔	30353	520672
1.6 16V, 78 kW	05.97 -		
2.0 16V, 98 kW	05.97 -		
Trag-/Führungsgelenk / Support-/ Steering Link	↕↔	29665	96300648
1.6 16V, 78 kW	05.97 -		
2.0 16V, 98 kW	05.97 -		
Faltenbalgsatz, Lenkung / Bellow Kit, steering system		30194	5 20 738
1.6 16V, 78 kW	05.97 -		
2.0 16V, 98 kW	05.97 -		

NUBIRA Wagon/Estate/Break (KLAJ)

05.97 -

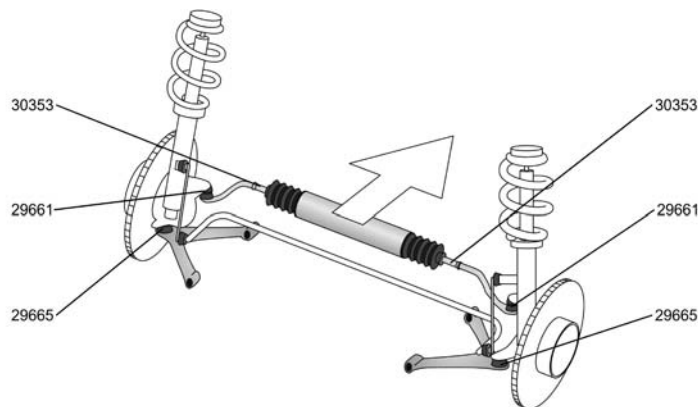

Spurstangenkopf / Tie-rod End	↔	29661	96205809
1.6 16V, 78 kW	05.97 -		
2.0 16V, 98 kW	05.97 -		
Axialgelenk, Spurstange / Axial Rod, tie rod	↔	30353	520672
1.6 16V, 78 kW	05.97 -		
2.0 16V, 98 kW	05.97 -		
Trag-/Führungsgelenk / Support-/ Steering Link	↕↔	29665	96300648
1.6 16V, 78 kW	05.97 -		
2.0 16V, 98 kW	05.97 -		



OE

DAEWOO

NUBIRA Wagon/Estate/Break (KLAJ)

05.97 -



Faltenbalgsatz, Lenkung / Bellow Kit, steering system

1.6 16V, 78 kW
2.0 16V, 98 kW

05.97 -
05.97 -

30194

5 20 738



TICO (KLY3)

02.95 -

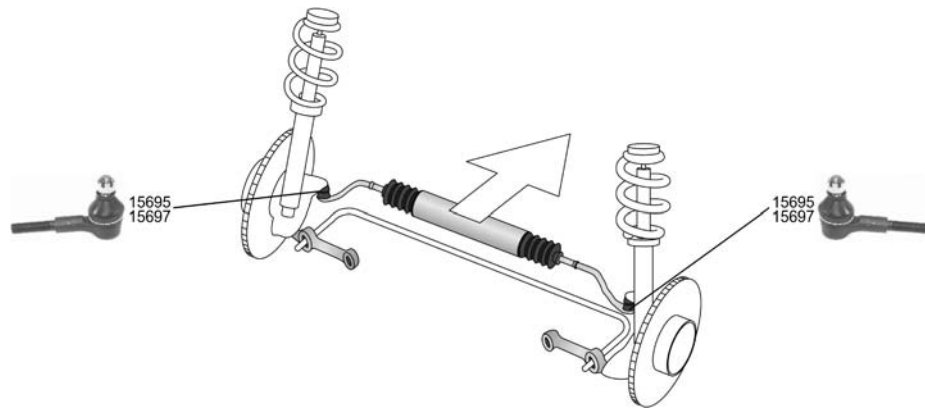

Spurstangenkopf / Tie-rod End

Gewindeart: mit Rechtsgewinde / Thread Type: with right-hand thread
Gewindemaß / Thread Size:M12x1,25

ALL TYPES



15695



Spurstangenkopf / Tie-rod End

Gewindeart: mit Rechtsgewinde / Thread Type: with right-hand thread
Gewindemaß / Thread Size:M12x1,25

Innengewinde [mm] / Inner Thread [mm]:M12x1,25

ALL TYPES



15697



Arithmetische Liste / Part number list

Artikelnummer Article No.	Seite Page	Hersteller Manufacturer	Artikelnummer Article No.	Seite Page	Hersteller Manufacturer
12148	3	DAEWOO	29665	7 8	DAEWOO
Trag-/Führungsgelenk / Support-/ Steering Link			Trag-/Führungsgelenk / Support-/ Steering Link		
12152	1 5 6	DAEWOO	30194	4 7 8	DAEWOO
Trag-/Führungsgelenk / Support-/ Steering Link			Faltenbalsatz, Lenkung / Bellow Kit, steering system	9	
12156	1 5 6	DAEWOO	30244	1 3	DAEWOO
Spurstange / Tie Rod, steering			Faltenbalsatz, Lenkung / Bellow Kit, steering system		
12157	1 5 6	DAEWOO	30353	7 8	DAEWOO
Spurstange / Tie Rod, steering			Axialgelenk, Spurstange / Axial Rod, tie rod		
12170	2	DAEWOO			
Axialgelenk, Spurstange / Axial Rod, tie rod					
12171	2	DAEWOO			
Axialgelenk, Spurstange / Axial Rod, tie rod					
12172	1 2 3	DAEWOO			
Spurstangenkopf / Tie-rod End	4 5 6				
12173	1 2 3	DAEWOO			
Spurstangenkopf / Tie-rod End	4 5 6				
12174	2 3 4	DAEWOO			
Spurstangenkopf / Tie-rod End					
12178	2	DAEWOO			
Spurstangenkopf / Tie-rod End					
12214	1 5 6	DAEWOO			
Lenker, Radaufhängung / Track Control Arm					
12219	1 1 5	DAEWOO			
Lagerung, Lenker / Mounting, wishbone	5 7				
12220	1 5 6	DAEWOO			
14642	1 5 7	DAEWOO			
Schraube, Spureinstellung / Bolt, wheel alignment					
14726	2 6 7	DAEWOO			
Achskörperlager / Mounting, axle body					
15695	9	DAEWOO			
Spurstangenkopf / Tie-rod End					
15697	9	DAEWOO			
Spurstangenkopf / Tie-rod End					
17739	3	DAEWOO			
Trag-/Führungsgelenk / Support-/ Steering Link					
25147	2	DAEWOO			
Spurstangenkopf / Tie-rod End					
29661	4 7 8	DAEWOO			
Spurstangenkopf / Tie-rod End					

Vergleichsliste / Cross reference list

Vergleichs-Nr. Compare No.	Artikelnummer Article No.	Vergleichs-Nr. Compare No.	Artikelnummer Article No.	Vergleichs-Nr. Compare No.	Artikelnummer Article No.
DAEWOO					
078 48 281	12156				
078 48 282	12157				
260 01 806	12172				
260 01 807	12173				
5 20 540	30244				
5 20 738	30194				
520672	30353				
947 88 122	12152				
96205809	29661				
96300648	29665				

Neuaufnahmen / New to range

Artikelnummer Article No.	Seite Page	Hersteller Manufacturer	Artikelnummer Article No.	Seite Page	Hersteller Manufacturer
12219 ▾⊕①	1 1 5 5 7	DAEWOO			
12220	1 5 6	DAEWOO			
14726 ⊕①	2 6 7	DAEWOO			
15695 ⊕♂	9	DAEWOO			
25147 ⊕	2	DAEWOO			
29661 ⊕	4 7 8	DAEWOO			
29665 ▾⊕	7 8	DAEWOO			
30194	4 7 8 9	DAEWOO			
30244 ⊕	1 3	DAEWOO			
30353 ⊕	7 8	DAEWOO			

Geänderte Bestellnummer / Amended part numbers

Artikelnummer alt Article No. old	Artikelnummer neu Article No. new	Artikelnummer alt Article No. old	Artikelnummer neu Article No. new	Artikelnummer alt Article No. old	Artikelnummer neu Article No. new

Geänderte Bestellnummer / Amended part numbers

Artikelnummer neu Article No. new	Artikelnummer alt Article No. old	Artikelnummer neu Article No. new	Artikelnummer alt Article No. old	Artikelnummer neu Article No. new	Artikelnummer alt Article No. old