







OE

ALFA ROMEO

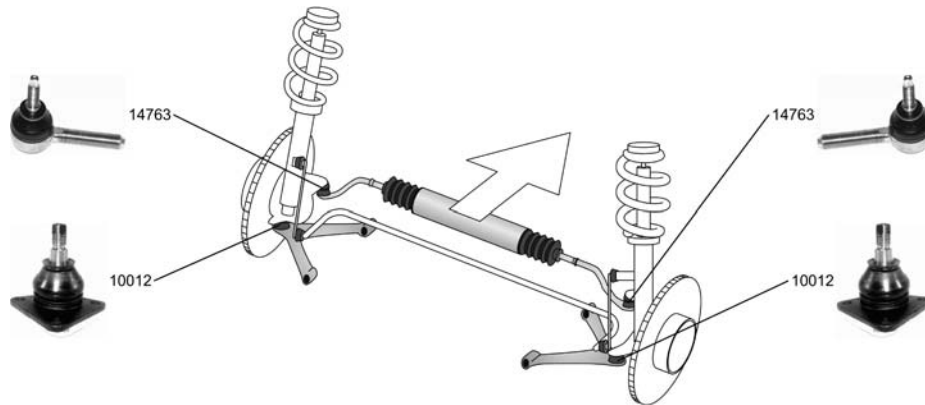
33 (905)

05.83 - 12.93







<p>Spurstangenkopf / Tie-rod End Gewindemaß / Thread Size: M14x1,5 Gewindeart: mit Rechtsgewinde / Thread Type: with right-hand thread ALL TYPES</p>		<p>14763 60 535 946</p> 
<p>Trag-/Führungsgelenk / Support-/ Steering Link ALL TYPES</p>		<p>10012 60 501 398</p> 

33 Sportwagen/Estate/Break (905A)

01.84 - 12.89



<p>Spurstangenkopf / Tie-rod End Gewindemaß / Thread Size: M14x1,5 Gewindeart: mit Rechtsgewinde / Thread Type: with right-hand thread ALL TYPES</p>		<p>14763 60 535 946</p> 
<p>Trag-/Führungsgelenk / Support-/ Steering Link ALL TYPES</p>		<p>10012 60 501 398</p> 





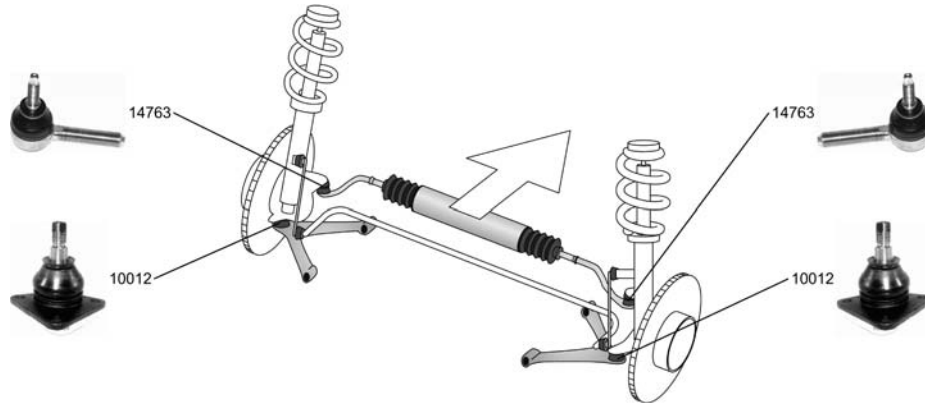

ALFA ROMEO

33 (907A)

01.90 - 09.94





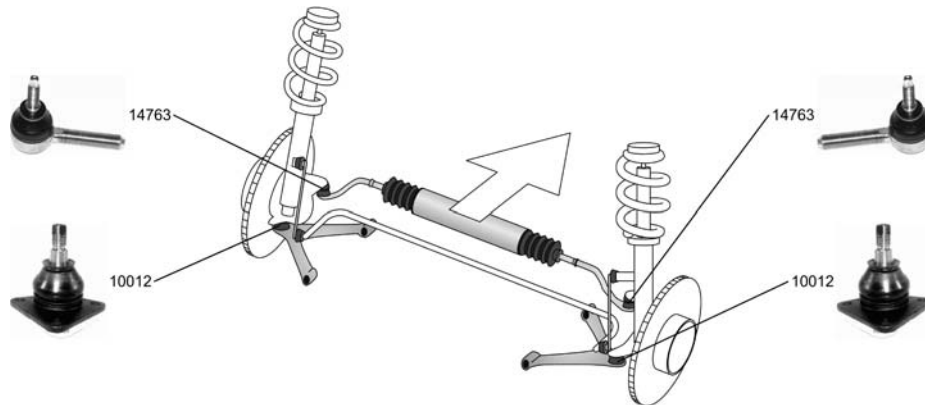

<p>Spurstangenkopf / Tie-rod End Gewindemaß / Thread Size: M14x1,5 Gewindeart: mit Rechtsgewinde / Thread Type: with right-hand thread ALL TYPES ausser/except for : 1.5 01.90 - 04.93</p>		<p>14763 60 535 946</p> 
<p>Trag-/Führungsgelenk / Support-/ Steering Link ALL TYPES ausser/except for : 1.5 01.90 - 04.93</p>		<p>10012 60 501 398</p> 

33 Sportwagen/Estate/Break (907B)

01.90 - 09.94



<p>Spurstangenkopf / Tie-rod End Gewindemaß / Thread Size: M14x1,5 Gewindeart: mit Rechtsgewinde / Thread Type: with right-hand thread ALL TYPES</p>		<p>14763 60 535 946</p> 
<p>Trag-/Führungsgelenk / Support-/ Steering Link ALL TYPES</p>		<p>10012 60 501 398</p> 











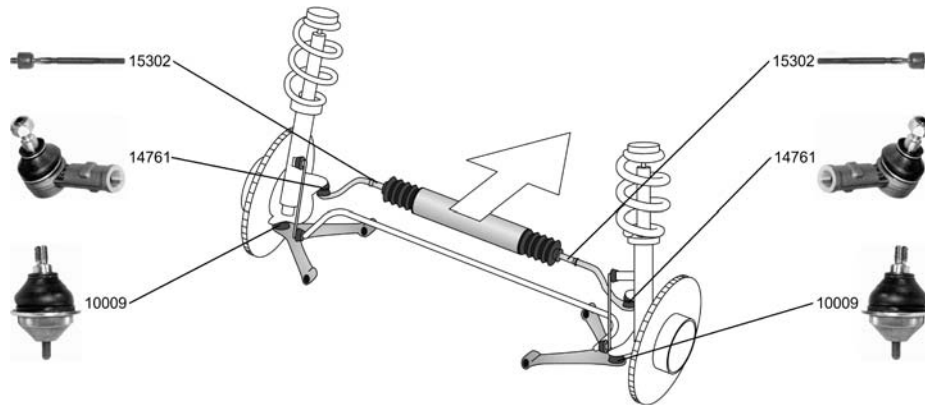

OE

ALFA ROMEO

75 (162B)

05.85 - 02.92



<p>Spurstangenkopf / Tie-rod End Gewindeart: mit Rechtsgewinde / Thread Type: with right-hand thread Gewindemaß / Thread Size:M14x1,5</p>		<p>14761 60 521 320</p>
<p>ALL TYPES</p>		
<p>Axialgelenk, Spurstange / Axial Rod, tie rod Gewindemaß / Thread Size:M14x1,5 Gewindeart: mit Rechtsgewinde / Thread Type: with right-hand thread</p>		<p>15302 60 724 204</p>
<p>ALL TYPES</p>	<p>für / for:Spica</p>	
<p>Trag-/Führungsgelenk / Support-/ Steering Link ALL TYPES</p>		<p>10009 60 521 236</p>
<p>ALL TYPES</p>		
<p>Lagerung, Lenker / Mounting, wishbone ALL TYPES</p>		<p>10010 60 521 240</p>
<p>ALL TYPES</p>		
<p>Faltenbalgsatz, Lenkung / Bellow Kit, steering system Innendurchmesser 1 [mm] / Inner Diameter 1 [mm]:12 Innendurchmesser 2 [mm] / Inner Diameter 2 [mm]:47</p>		<p>30125 60 724 111</p>
<p>ALL TYPES</p>		









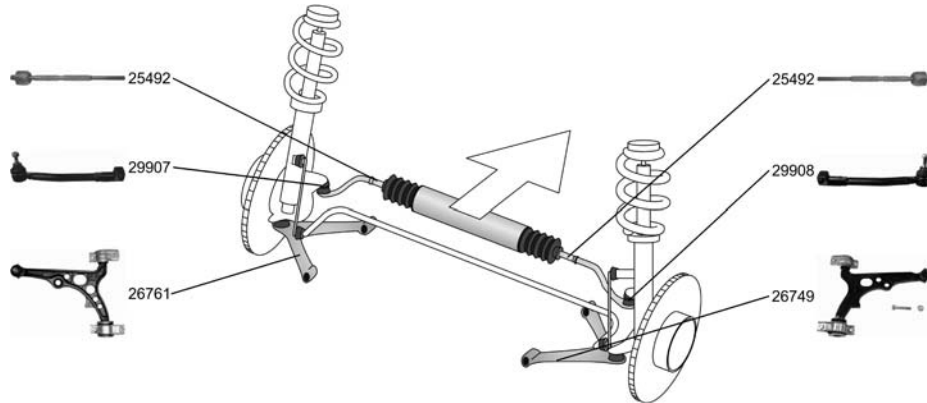



ALFA ROMEO

145 (930)

07.94 - 01.01





Spurstangenkopf / Tie-rod End			29907	60 608 979
1.4 i.e.	07.94 - 12.96			
1.4 i.e. 16V T.S.	12.96 - 01.01			
1.6 i.e. 16V T.S.	12.96 - 01.01			
1.8 i.e. 16V T.S.	12.96 - 12.98			
Spurstangenkopf / Tie-rod End Konusmaß [mm] / Cone Size [mm]:14			29908	60 608 980
1.4 i.e.	07.94 - 12.96			
1.4 i.e. 16V T.S.	12.96 - 01.01			
1.6 i.e. 16V T.S.	12.96 - 01.01			
1.8 i.e. 16V T.S.	12.96 - 12.98			
Axialgelenk, Spurstange / Axial Rod, tie rod			25492	9 947 361
2.0 16V T.S.	10.95 - 01.01			
2.0 16V Quadrifoglio	03.98 - 01.01			
Lenker, Radaufhängung / Track Control Arm			26749	60 812 797
ALL TYPES ausser/except for :				
1.7 i.e. 16V T.S.	03.98 -			
Lenker, Radaufhängung / Track Control Arm			26761	60 812 796
ALL TYPES ausser/except for :				
1.7 i.e. 16V T.S.	03.98 -			

146 (930)

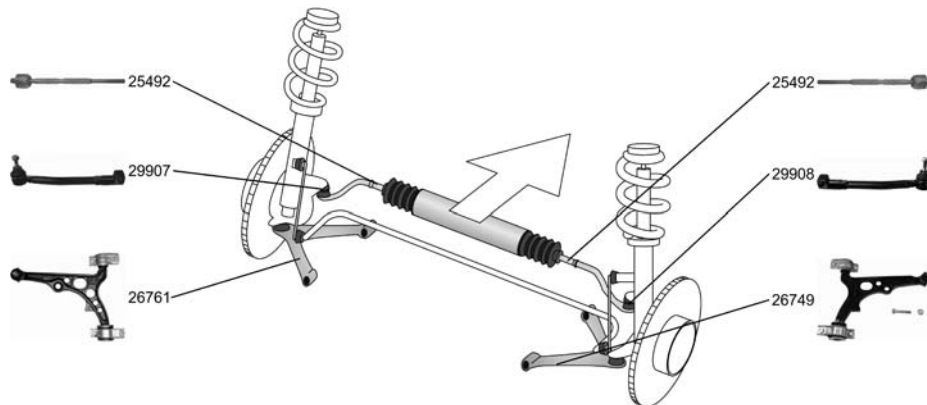
12.94 - 01.01











Spurstangenkopf / Tie-rod End			29907	60 608 979
1.4 i.e.	12.94 - 12.96			
1.6 i.e.	12.94 - 12.96			
1.7 i.e. 16V	12.94 - 12.96			



OE

ALFA ROMEO

146 (930) 12.94 - 01.01

 Spurstangenkopf / Tie-rod End Konusmaß [mm] / Cone Size [mm]:14	1.4 i.e. 12.94 - 12.96		29908 60 608 980 
	1.6 i.e. 12.94 - 12.96		
	1.7 i.e. 16V 12.94 - 12.96		
Axialgelenk, Spurstange / Axial Rod, tie rod	2.0 16V T.S. 10.95 - 01.01 2.0 16V Quadrifoglio 03.98 - 01.01		25492 9 947 361 
Lenker, Radaufhängung / Track Control Arm ALL TYPES ausser/except for : 2.0 16V T.I. 03.98 -			26749 60 812 797 
Lenker, Radaufhängung / Track Control Arm ALL TYPES ausser/except for : 2.0 16V T.I. 03.98 -			26761 60 812 796 

147 (937) 01.01 -

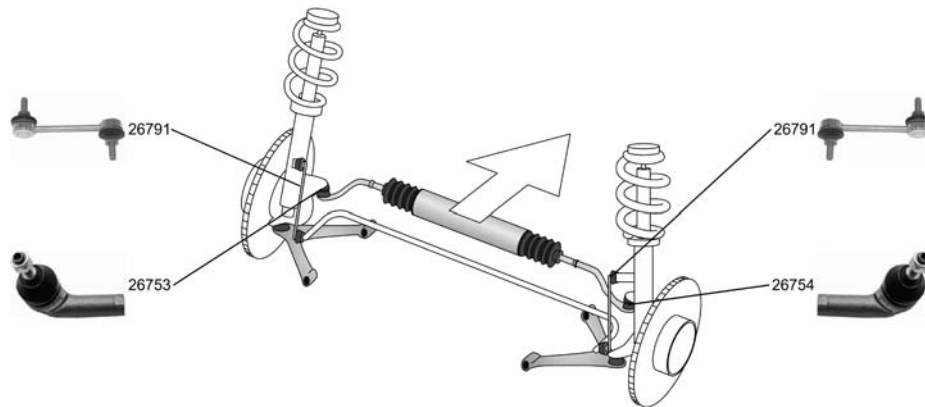

Spurstangenkopf / Tie-rod End ALL TYPES ausser/except for : 1.9 JTDM 8V 07.05 - 1.9 JTDM 16V 07.05 -			26753 9 947 919 
Spurstangenkopf / Tie-rod End ALL TYPES ausser/except for : 1.9 JTDM 8V 07.05 - 1.9 JTDM 16V 07.05 -			26754 9 947 920 
Stange/Strebe, Stabilisator / Rod/Strut, stabiliser Pendelstange / Suspension Rod ohne Zubehör / without accessories ALL TYPES ausser/except for : 1.9 JTDM 8V 07.05 - 1.9 JTDM 16V 07.05 -			26791 46 843 389 
 Stange/Strebe, Stabilisator / Rod/Strut, stabiliser Koppelstange / Coupling Rod ALL TYPES ausser/except for : 1.9 JTDM 8V 07.05 - 1.9 JTDM 16V 07.05 -			29198 60 613 575 









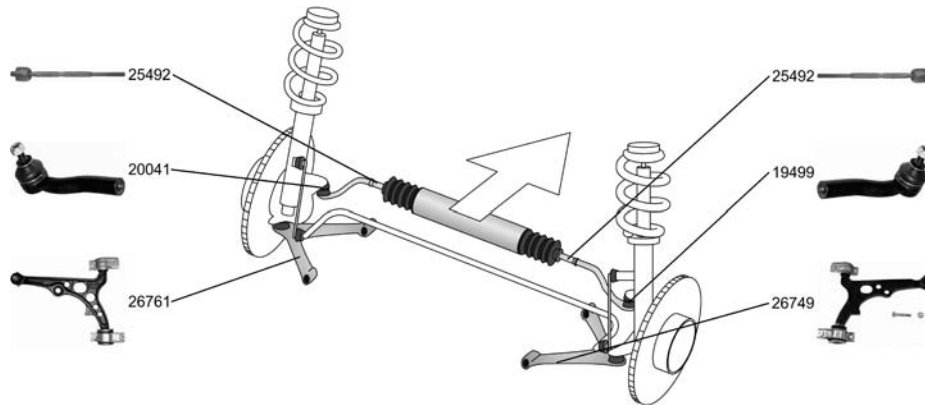



ALFA ROMEO

155 (167)

01.92 - 12.97



<p>Spurstangenkopf / Tie-rod End Gewindeart: mit Rechtsgewinde / Thread Type: with right-hand thread Gewindemaß / Thread Size:M12x1,5</p>		<p>19499 9 947 436</p> 
<p>ALL TYPES</p> <p>Spurstangenkopf / Tie-rod End Gewindemaß / Thread Size:M12x1,5 Gewindeart: mit Rechtsgewinde / Thread Type: with right-hand thread Innengewinde [mm] / Inner Thread [mm]:M12x1,5</p>		<p>20041 9 947 435</p> 
<p>Axialgelenk, Spurstange / Axial Rod, tie rod</p> <p>1.8 T.S. 02.92 - 12.97 1.8 T.S. Sport (167.A4A, 167.A4C, 167.A4E) 01.92 - 12.96 2.0 T.S. (167.A2A) 02.92 - 02.95 2.0 T.S. (167.A2) 02.92 - 04.93 2.0 T.S. 16V (167.A2G) 03.95 - 12.97 2.0 16V Turbo Q4 (167.A2B, 167.A2C, 167.A2E) 01.92 - 12.97 2.0 16V Turbo Q4 01.92 - 12.97 2.5 V6 (167.A1C, 167.A1E) 10.92 - 12.97 2.5 V6 (167.A1) 02.92 - 09.96 2.5 TD (167.A1A) 04.93 - 12.97</p>		<p>25492 9 947 361</p> 
<p>Lenker, Radaufhängung / Track Control Arm</p> <p>ALL TYPES</p>		<p>26749 60 812 797</p> 
<p>Lenker, Radaufhängung / Track Control Arm</p> <p>ALL TYPES</p>		<p>26761 60 812 796</p> 









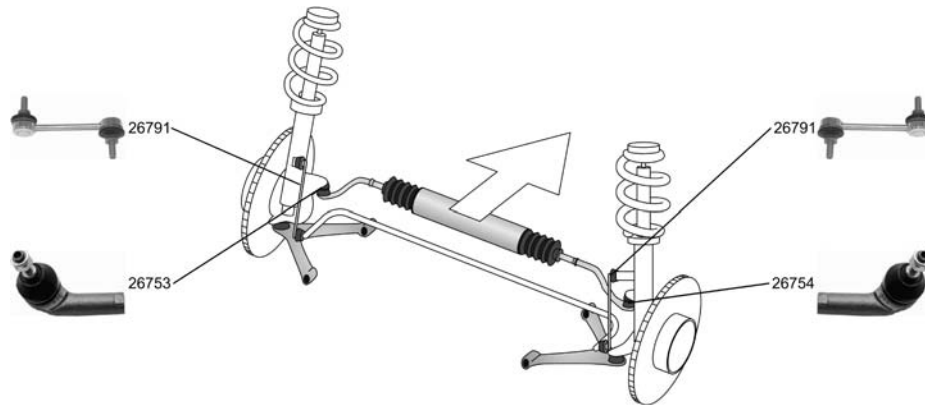

OE

ALFA ROMEO

156 (932)

09.97 -





Spurstangenkopf / Tie-rod End ALL TYPES		26753 9 947 919
		
Spurstangenkopf / Tie-rod End ALL TYPES		26754 9 947 920
		
Stange/Strebe, Stabilisator / Rod/Strut, stabiliser Pendelstange / Suspension Rod ohne Zubehör / without accessories ALL TYPES		26791 46 843 389
		
 Stange/Strebe, Stabilisator / Rod/Strut, stabiliser Koppelstange / Coupling Rod ALL TYPES		29198 60 613 575

156 Sportwagon/Estate/Break (932)

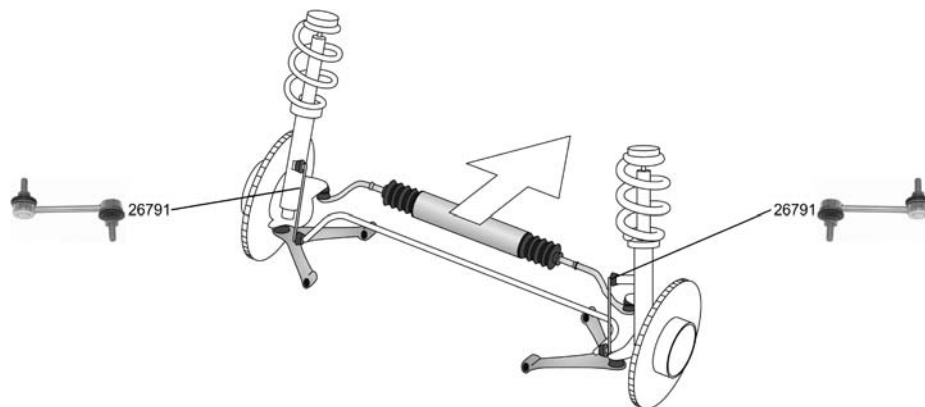
05.00 -



Stange/Strebe, Stabilisator / Rod/Strut, stabiliser Pendelstange / Suspension Rod ohne Zubehör / without accessories ALL TYPES		26791 46 843 389
 Stange/Strebe, Stabilisator / Rod/Strut, stabiliser Koppelstange / Coupling Rod ALL TYPES		29198 60 613 575







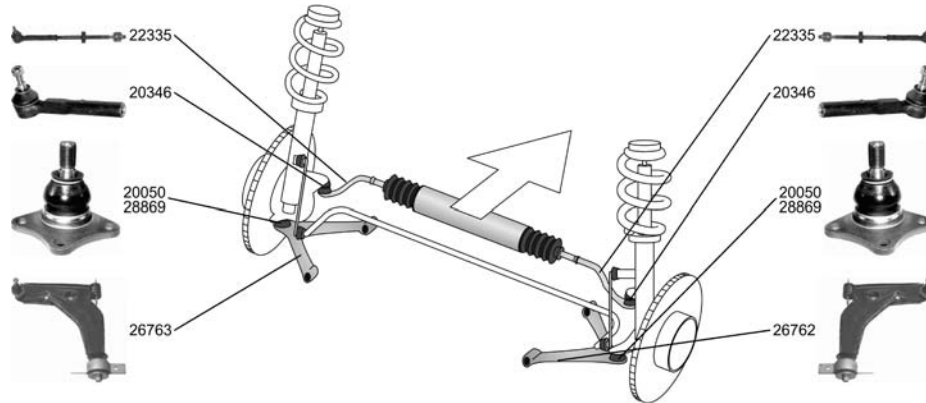

ALFA ROMEO

164 (164)

01.87 - 09.98





Spurstange / Tie Rod, steering ALL TYPES		22335 00605 11606
		
Spurstangenkopf / Tie-rod End Gewindeart: mit Rechtsgewinde / Thread Type: with right-hand thread Aussengewinde [mm] / Outer Thread [mm]:M14x1,5 Konusmaß [mm] / Cone Size [mm]:14 mit Zubehör / With accessories ALL TYPES		20346 60 511 622
Lenker, Radaufhängung / Track Control Arm 2.0 T.S. (164.A2C, 164.A2L) 06.87 - 09.92 2.0 T.S. (164.A2H) 06.87 - 12.90 2.0 V6 Turbo (164.A2G, 164.A2F) 03.91 - 09.92 3.0 V6 (164.AD, 164.AH, 164.AB) 06.87 - 09.92 3.0 V6 (164.A) 06.87 - 09.92 3.0 i.e. QV (164.AG) 09.90 - 09.92 2.5 TD (164.A1A) 06.87 - 09.92 2.0 06.87 - 09.98 2.0 Turbo 10.87 - 09.98		26762 60 510 362
Lenker, Radaufhängung / Track Control Arm 2.0 T.S. (164.A2C, 164.A2L) 06.87 - 09.92 2.0 T.S. (164.A2H) 06.87 - 12.90 2.0 V6 Turbo (164.A2G, 164.A2F) 03.91 - 09.92 3.0 V6 (164.AD, 164.AH, 164.AB) 06.87 - 09.92 3.0 V6 (164.A) 06.87 - 09.92 3.0 i.e. QV (164.AG) 09.90 - 09.92 2.5 TD (164.A1A) 06.87 - 09.92 2.0 06.87 - 09.98 2.0 Turbo 10.87 - 09.98		26763 60 510 363
Trag-/Führungsgelenk / Support-/ Steering Link ohne Zubehör / without accessories 2.0 06.87 - 09.98 2.0 V6 Turbo (164.K3) 09.92 - 09.98 2.0 V6 Turbo (164.A2G, 164.A2F) 03.91 - 09.92 2.5 V6 09.92 - 09.98 3.0 V6 (164.H1A, 164.H1B, 164.K1P) 09.92 - 09.98 3.0 V6 (164.AD, 164.AH, 164.AB) 06.87 - 09.92 3.0 V6 (164.A) 06.87 - 09.92 2.5 TD (164.K2A, 164.K2B) 09.92 - 09.98		20050 60 510 360
Trag-/Führungsgelenk / Support-/ Steering Link Konusmaß [mm] / Cone Size [mm]:13 2.0 T.S. (164.A2C, 164.A2L) 06.87 - 09.92 2.0 T.S. (164.H3) 09.92 - 09.98 2.0 T.S. (164.A2H) 06.87 - 12.90 2.5 TD (164.K2A, 164.K2B) 09.92 - 09.98 2.5 TD (164.A1A) 06.87 - 09.92		28869



OE





ALFA ROMEO

164 (164) 01.87 - 09.98

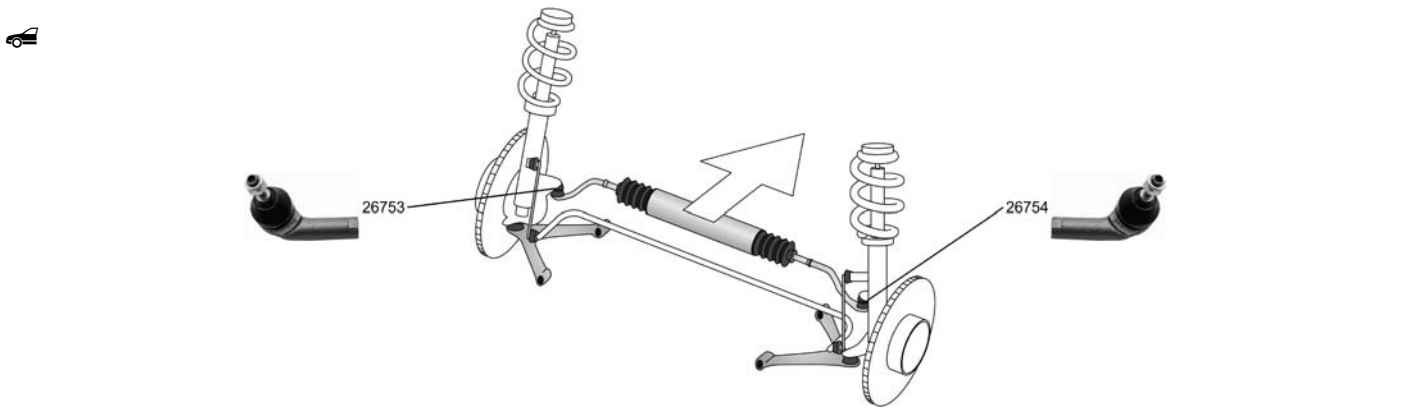
 Faltenbalsatz, Lenkung / Bellow Kit, steering system Innendurchmesser 1 [mm] / Inner Diameter 1 [mm]:10 Innendurchmesser 2 [mm] / Inner Diameter 2 [mm]:44		30184 9 938 779-R 





166 (936) 09.98 -

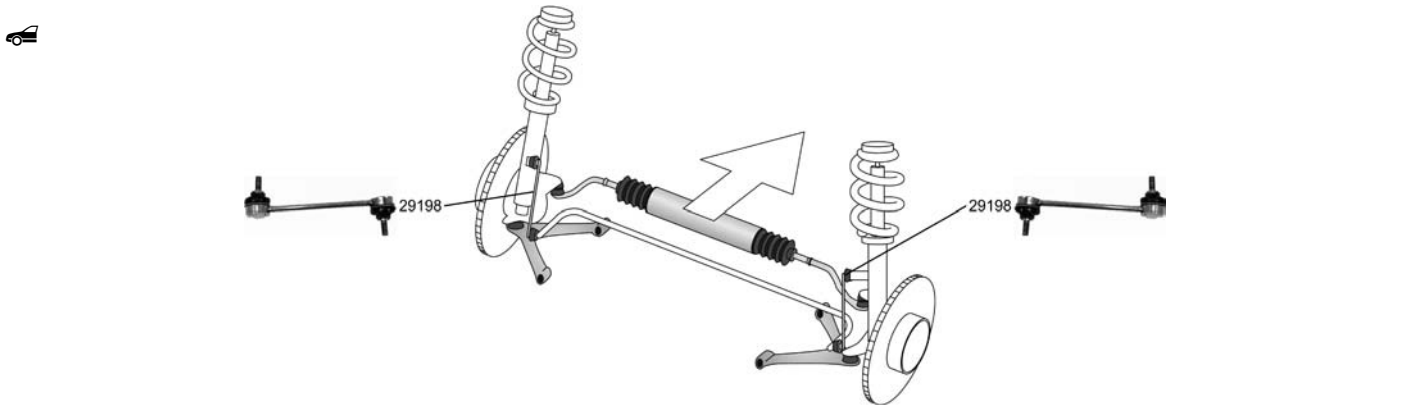

Spurstangenkopf / Tie-rod End ALL TYPES ausser/except for : 3.2 V6 24V 10.03 - 2.4 JTD, 129 kW 10.03 -		26753 9 947 919 
Spurstangenkopf / Tie-rod End ALL TYPES ausser/except for : 3.2 V6 24V 10.03 - 2.4 JTD, 129 kW 10.03 -		26754 9 947 920 















GT 11.03 -



Spurstangenkopf / Tie-rod End ALL TYPES		26753 9 947 919 
Spurstangenkopf / Tie-rod End ALL TYPES		26754 9 947 920 





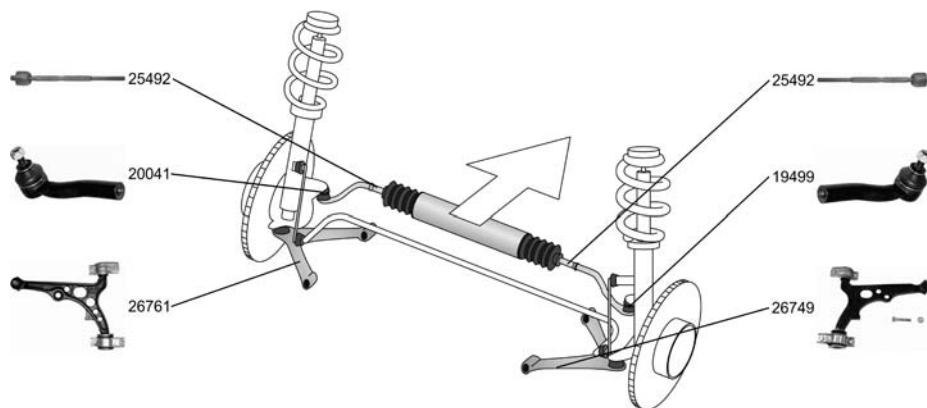

ALFA ROMEO

GT		11.03 -	
	Stange/Strebe, Stabilisator / Rod/Strut, stabiliser Koppelstange / Coupling Rod ALL TYPES		29198 60 613 575 
GTV (116)		01.78 - 02.87	
	Spurstangenkopf / Tie-rod End Gewindeart: mit Rechtsgewinde / Thread Type: with right-hand thread Gewindemaß / Thread Size:M14x1,5 ALL TYPES		14761 60 521 320 
	Axialgelenk, Spurstange / Axial Rod, tie rod Gewindemaß / Thread Size:M14x1,5 Gewindeart: mit Rechtsgewinde / Thread Type: with right-hand thread ALL TYPES		15302 60 724 204 
	Axialgelenk, Spurstange / Axial Rod, tie rod Gewindeart: mit Rechtsgewinde / Thread Type: with right-hand thread Gewindemaß / Thread Size:M14x1,5 6 2.5 (116.CA) 11.80 - 02.87		17759 
	Trag-/Führungsgelenk / Support-/ Steering Link 2.0 (116.36 E) 01.85 - 12.85 2.0 07.78 - 01.86 6 2.5 (116.CA) 11.80 - 02.87 2.0 Turbodelta 01.78 - 12.80		10009 60 521 236 
	Lagerung, Lenker / Mounting, wishbone 2.0 (116.36 E) 01.85 - 12.85 2.0 07.78 - 01.86 6 2.5 (116.CA) 11.80 - 02.87		10010 60 521 240 

GTV (916C_) 09.94 -



Spurstangenkopf / Tie-rod End Gewindeart: mit Rechtsgewinde / Thread Type: with right-hand thread Gewindemaß / Thread Size:M12x1,5 ALL TYPES ausser/except for : 2.0 JTS 04.03 - 3.2 V6 24V 04.03 -		19499 9 947 436 
Spurstangenkopf / Tie-rod End Gewindemaß / Thread Size:M12x1,5 Gewindeart: mit Rechtsgewinde / Thread Type: with right-hand thread Innengewinde [mm] / Inner Thread [mm]:M12x1,5 ALL TYPES ausser/except for : 2.0 JTS 04.03 - 3.2 V6 24V 04.03 -		20041 9 947 435 











OE

ALFA ROMEO

GTV (916C_)







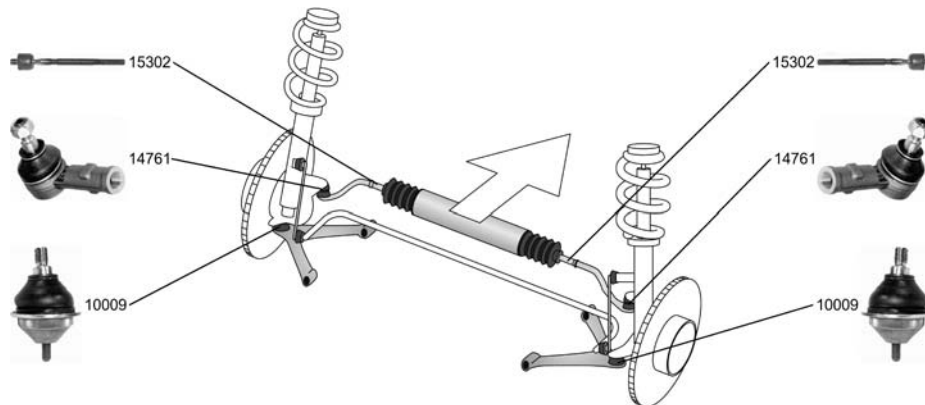

09.94 -

 Axialgelenk, Spurstange / Axial Rod, tie rod 2.0 T.SPARK 16V (916.C2__, 916C2C00) 2.0 T.SPARK 16V (916C2C) 2.0 V6 Turbo (916.C2A)	06.95 - 05.98 - 08.00 06.95 -		25492 9 947 361 	
	Lenker, Radaufhängung / Track Control Arm ALL TYPES			26749 60 812 797 
Lenker, Radaufhängung / Track Control Arm ALL TYPES			26761 60 812 796 	
 Trag-/Führungsgelenk / Support-/ Steering Link mit Zubehör / With accessories ALL TYPES				27715 60 612 294 60 627 604 60 627 605

RZ

01.92 - 12.94



Spurstangenkopf / Tie-rod End Gewindeart: mit Rechtsgewinde / Thread Type: with right-hand thread Gewindemaß / Thread Size:M14x1,5 ALL TYPES		14761 60 521 320 
Axialgelenk, Spurstange / Axial Rod, tie rod Gewindemaß / Thread Size:M14x1,5 Gewindeart: mit Rechtsgewinde / Thread Type: with right-hand thread ALL TYPES		15302 60 724 204 
Trag-/Führungsgelenk / Support-/ Steering Link ALL TYPES		10009 60 521 236 
Lagerung, Lenker / Mounting, wishbone ALL TYPES		10010 60 521 240 









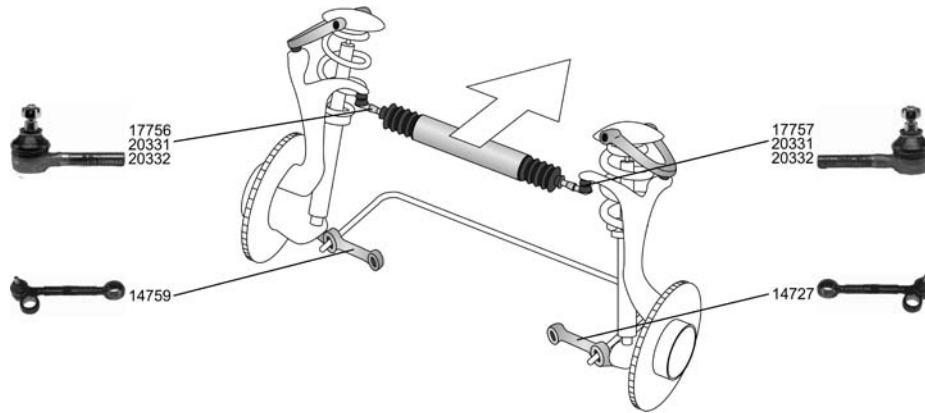







ALFA ROMEO

SPIDER (115)

03.71 - 12.93



<p>Spurstangenkopf / Tie-rod End Gewindemaß / Thread Size:M14x1,5 Gewindeart: mit Linksgewinde / Thread Type: With left-hand thread ALL TYPES</p>		<p>17756 60 777 585</p> 
<p>Spurstangenkopf / Tie-rod End Gewindemaß / Thread Size:M14x1,5 Gewindeart: mit Rechtsgewinde / Thread Type: with right-hand thread ALL TYPES</p>		<p>17757 60 777 584</p> 
<p>Spurstangenkopf / Tie-rod End Gewindemaß / Thread Size:M14x1,5 Gewindeart: mit Rechtsgewinde / Thread Type: with right-hand thread ALL TYPES</p>		<p>20331 60 710 237</p> 
<p>Spurstangenkopf / Tie-rod End Gewindemaß / Thread Size:M14x1,5 Gewindeart: mit Linksgewinde / Thread Type: With left-hand thread ALL TYPES</p>		<p>20332 60 710 238</p> 
<p>Lenker, Radaufhängung / Track Control Arm ALL TYPES</p>		<p>14727 60 516 895</p> 
<p>Lenker, Radaufhängung / Track Control Arm ALL TYPES</p>		<p>14759 60 516 894</p> 
<p>Lagerung, Lenker / Mounting, wishbone ALL TYPES</p>		<p>10011 60 735 521</p> 











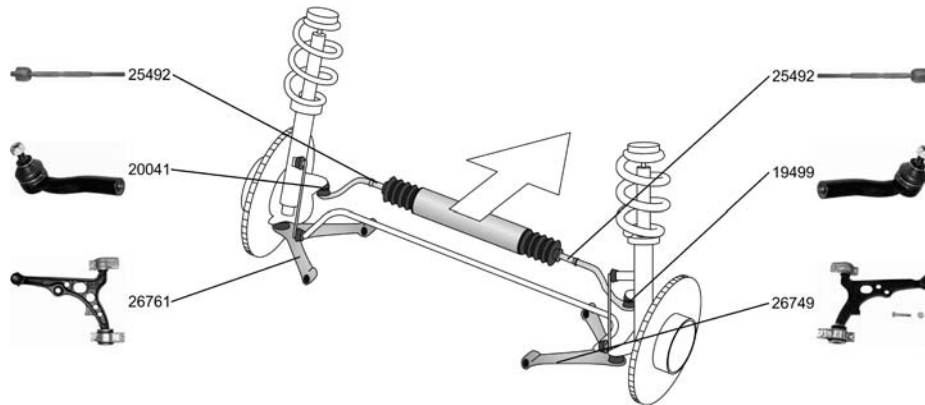



OE

ALFA ROMEO

SPIDER (916S_)

09.94 -



<p>Spurstangenkopf / Tie-rod End Gewindeart: mit Rechtsgewinde / Thread Type: with right-hand thread Gewindemaß / Thread Size:M12x1,5</p> <p>ALL TYPES ausser/except for :</p> <table border="1"> <tr> <td>2.0 JTS</td> <td>04.03 -</td> </tr> <tr> <td>3.2 V6 24V</td> <td>04.03 -</td> </tr> </table>	2.0 JTS	04.03 -	3.2 V6 24V	04.03 -		<p>19499 9 947 436</p> 
2.0 JTS	04.03 -					
3.2 V6 24V	04.03 -					
<p>Spurstangenkopf / Tie-rod End Gewindemaß / Thread Size:M12x1,5 Gewindeart: mit Rechtsgewinde / Thread Type: with right-hand thread Innengewinde [mm] / Inner Thread [mm]:M12x1,5</p> <p>ALL TYPES ausser/except for :</p> <table border="1"> <tr> <td>2.0 JTS</td> <td>04.03 -</td> </tr> <tr> <td>3.2 V6 24V</td> <td>04.03 -</td> </tr> </table>	2.0 JTS	04.03 -	3.2 V6 24V	04.03 -		<p>20041 9 947 435</p> 
2.0 JTS	04.03 -					
3.2 V6 24V	04.03 -					
<p>Axialgelenk, Spurstange / Axial Rod, tie rod</p> <table border="1"> <tr> <td>2.0 T.SPARK 16V (916S2C00)</td> <td>06.95 -</td> </tr> <tr> <td>2.0 T.SPARK 16V (916S2B)</td> <td>05.98 - 08.00</td> </tr> </table>	2.0 T.SPARK 16V (916S2C00)	06.95 -	2.0 T.SPARK 16V (916S2B)	05.98 - 08.00		<p>25492 9 947 361</p> 
2.0 T.SPARK 16V (916S2C00)	06.95 -					
2.0 T.SPARK 16V (916S2B)	05.98 - 08.00					
<p>Lenker, Radaufhängung / Track Control Arm ALL TYPES</p>		<p>26749 60 812 797</p> 				
<p>Lenker, Radaufhängung / Track Control Arm ALL TYPES</p>		<p>26761 60 812 796</p> 				
<p> Trag-/Führungsgelenk / Support-/ Steering Link mit Zubehör / With accessories</p> <p>ALL TYPES</p>		<p>27715 60 612 294 60 627 604 60 627 605</p>				









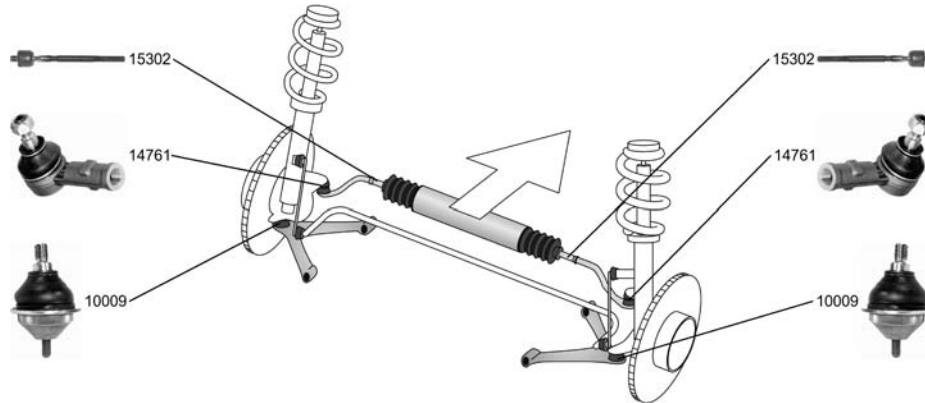

ALFA ROMEO

SZ

09.88 - 08.94



<p>Spurstangenkopf / Tie-rod End Gewindeart: mit Rechtsgewinde / Thread Type: with right-hand thread Gewindemaß / Thread Size:M14x1,5</p>		<p>14761 60 521 320</p> 
<p>ALL TYPES</p>		
<p>Axialgelenk, Spurstange / Axial Rod, tie rod Gewindemaß / Thread Size:M14x1,5 Gewindeart: mit Rechtsgewinde / Thread Type: with right-hand thread</p>		<p>15302 60 724 204</p> 
<p>ALL TYPES</p>	<p>für / for:Spica</p>	
<p>Trag-/Führungsgelenk / Support-/ Steering Link</p>		<p>10009 60 521 236</p> 
<p>ALL TYPES</p>		
<p>Lagerung, Lenker / Mounting, wishbone</p>		<p>10010 60 521 240</p> 
<p>ALL TYPES</p>		

Arithmetische Liste / Part number list

Artikelnummer Article No.	Seite Page	Hersteller Manufacturer	Artikelnummer Article No.	Seite Page	Hersteller Manufacturer
10009 ▾⊕ Trag-/Führungsgelenk / Support-/ Steering Link	3 10 11 14	ALFA ROMEO	26749 ⊕ Lenker, Radaufhängung / Track Control Arm	4 5 6 11 13	ALFA ROMEO
10010 ⊕ Lagerung, Lenker / Mounting, wishbone	3 10 11 14	ALFA ROMEO	26753 ⊕ Spurstangenkopf / Tie-rod End	5 7 9	ALFA ROMEO
10011 ▲⊕ Lagerung, Lenker / Mounting, wishbone	12	ALFA ROMEO	26754 ⊕ Spurstangenkopf / Tie-rod End	5 7 9	ALFA ROMEO
10012 ▲▽⊕ Trag-/Führungsgelenk / Support-/ Steering Link	1 2	ALFA ROMEO	26761 ⊕ Lenker, Radaufhängung / Track Control Arm	4 5 6 11 13	ALFA ROMEO
14727 ▾⊕ Lenker, Radaufhängung / Track Control Arm	12	ALFA ROMEO	26762 ⊕ Lenker, Radaufhängung / Track Control Arm	8	ALFA ROMEO
14759 ▾⊕ Lenker, Radaufhängung / Track Control Arm	12	ALFA ROMEO	26763 ⊕ Lenker, Radaufhängung / Track Control Arm	8	ALFA ROMEO
14761 ⊕♂ Spurstangenkopf / Tie-rod End	3 10 11 14	ALFA ROMEO	26791 ⊕ Stange/Strebe, Stabilisator / Rod/Strut, stabiliser	5 7	ALFA ROMEO
14763 ▲⊕♂ Spurstangenkopf / Tie-rod End	1 2	ALFA ROMEO	27715 ▾⊕ Trag-/Führungsgelenk / Support-/ Steering Link	11 13	ALFA ROMEO
15302 ▲⊕♂ Axialgelenk, Spurstange / Axial Rod, tie rod	3 10 11 14	ALFA ROMEO	28869 ⊕ Trag-/Führungsgelenk / Support-/ Steering Link	8	ALFA ROMEO
17756 ⊕ Spurstangenkopf / Tie-rod End	12	ALFA ROMEO	29198 ⊕ Stange/Strebe, Stabilisator / Rod/Strut, stabiliser	5 7 10	ALFA ROMEO
17757 ⊕⊕ Spurstangenkopf / Tie-rod End	12	ALFA ROMEO	29907 ⊕ Spurstangenkopf / Tie-rod End	4	ALFA ROMEO
17759 ▲ Axialgelenk, Spurstange / Axial Rod, tie rod	10	ALFA ROMEO	29908 ⊕ Spurstangenkopf / Tie-rod End	4 5	ALFA ROMEO
19499 ⊕♂ Spurstangenkopf / Tie-rod End	6 10 13	ALFA ROMEO	30125 ⊕ Faltenbalgsatz, Lenkung / Bellow Kit, steering system	3	ALFA ROMEO
20041 ⊕ Spurstangenkopf / Tie-rod End	6 10 13	ALFA ROMEO	30184 ⊕⊕ Faltenbalgsatz, Lenkung / Bellow Kit, steering system	9	ALFA ROMEO
20050 ▾⊕ Trag-/Führungsgelenk / Support-/ Steering Link	8	ALFA ROMEO			
20331 ⊕♂ Spurstangenkopf / Tie-rod End	12	ALFA ROMEO			
20332 ⊕♂ Spurstangenkopf / Tie-rod End	12	ALFA ROMEO			
20346 ▲⊕♂ Spurstangenkopf / Tie-rod End	8	ALFA ROMEO			
22335 ⊕ Spurstange / Tie Rod, steering	8	ALFA ROMEO			
25492 ⊕⊕ Axialgelenk, Spurstange / Axial Rod, tie rod	4 5 6 11 13	ALFA ROMEO			

Vergleichsliste / Cross reference list

Vergleichs-Nr. Compare No.	Artikelnummer Article No.	Vergleichs-Nr. Compare No.	Artikelnummer Article No.	Vergleichs-Nr. Compare No.	Artikelnummer Article No.
ALFA ROMEO					
00605	11606		22335		
46 843	389		26791		
60 501	398		10012		
60 510	360		20050		
60 510	362		26762		
60 510	363		26763		
60 511	622		20346		
60 516	894		14759		
60 516	895		14727		
60 521	236		10009		
60 521	240		10010		
60 521	320		14761		
60 535	946		14763		
60 608	979		29907		
60 608	980		29908		
60 612	294		27715		
60 613	575		29198		
60 627	604		27715		
60 627	605		27715		
60 710	237		20331		
60 710	238		20332		
60 724	111		30125		
60 724	204		15302		
60 735	521		10011		
60 777	584		17757		
60 777	585		17756		
60 812	796		26761		
60 812	797		26749		
9 938	779-R		30184		
9 947	361		25492		
9 947	435		20041		
9 947	436		19499		
9 947	919		26753		
9 947	920		26754		

Neuaufnahmen / New to range

Artikelnummer Article No.	Seite Page	Hersteller Manufacturer	Artikelnummer Article No.	Seite Page	Hersteller Manufacturer
14727	12	ALFA ROMEO			
14759	12	ALFA ROMEO			
20041	6 10 13	ALFA ROMEO			
20331	12	ALFA ROMEO			
20332	12	ALFA ROMEO			
26749	4 5 6 11 13	ALFA ROMEO			
26753	5 7 9	ALFA ROMEO			
26754	5 7 9	ALFA ROMEO			
26761	4 5 6 11 13	ALFA ROMEO			
26762	8	ALFA ROMEO			
26763	8	ALFA ROMEO			
26791	5 7	ALFA ROMEO			
27715	11 13	ALFA ROMEO			
28869	8	ALFA ROMEO			
29198	5 7 10	ALFA ROMEO			
29907	4	ALFA ROMEO			
29908	4 5	ALFA ROMEO			
30125	3	ALFA ROMEO			
30184	9	ALFA ROMEO			

Geänderte Bestellnummer / Amended part numbers

Artikelnummer alt Article No. old	Artikelnummer neu Article No. new	Artikelnummer alt Article No. old	Artikelnummer neu Article No. new	Artikelnummer alt Article No. old	Artikelnummer neu Article No. new
025 160 102 622	22335				
14129	30125				
22195	29198				
25220	30184				
25479	25492				
27913	20346				

Geänderte Bestellnummer / Amended part numbers

Artikelnummer neu Article No. new	Artikelnummer alt Article No. old	Artikelnummer neu Article No. new	Artikelnummer alt Article No. old	Artikelnummer neu Article No. new	Artikelnummer alt Article No. old
20346	27913				
22335	025 160 102 622				
25492	25479				
29198	22195				
30125	14129				
30184	25220				

© ZF Trading GmbH - 16.10.06